



TECHNICAL REPORT

# STATE OF THE ART: CCS TECHNOLOGIES 2024



GLOBAL CCS  
INSTITUTE

HUGH BARLOW  
Carbon Capture Technology Lead

SHAHRZAD S M SHAHI  
Carbon Capture Technology Lead

# TABLE OF CONTENTS

FOREWORD	6		
EDITOR'S NOTES	8		
<b>CAPTURE</b>	<b>10</b>		
8RIVERS	12		
AIR LIQUIDE	16		
AXENS	24		
B&W	26		
BAKER HUGHES	34		
BASF	42		
CAPSOL TECHNOLOGIES	44		
CARBON AMERICA	50		
CARBON CLEAN	52		
CARBON ENGINEERING	54		
C-CAPTURE	56		
CHINA ENERGY	58		
CO2CRC	60		
ELESSENT CLEAN TECH	64		
EMERSON	66		
ENTROPY	72		
FLUOR	74		
FUELCELL ENERGY	76		
HONEYWELL	78		
INNOTECH ALBERTA	86		
ION CLEAN ENERGY	88		
K2CO2	90		
KC8	92		
LEILAC	94		
LINDE	96		
NETPOWER	108		
NOV	110		
NOVONESIS	118		
NUADA	120		
PETRONAS	122		
SAIPEM	124		
SHELL	126		
SINOPEC	130		
SLB AND AKER	134		
SUMITOMO	136		
SVANTE	142		
TECNICAS REUNIDAS	144		
AIRHIVE	147		
ARDENT	148		
ASPENTECH	149		
CAPTIVATE	150		
CAPTURA	151		
CARBONCO	152		
CARBONORO	153		
CEOX	154		
COOL PLANET TECH	155		
DELTA CLEANTECH	156		
EQUATIC	157		
KBR	158		
VALUE MARITIME	159		
		<b>TRANSPORT</b>	<b>160</b>
		BAKER HUGHES	162
		DRIL-QUIP	168
		KNCC	170
		KOBELCO	172
		MAXTUBE	174
		NIPPON STEEL	176
		NOV	178
		NEBULA ENERGY	180
		SOLATRON	181
		<b>STORAGE</b>	<b>182</b>
		BAKER HUGHES	184
		CARBFIX	196
		EXPRO	198
		MANGROVE SYSTEMS	202
		QUORUM SOFTWARE	204
		SAIPEM	210
		ASPENTECH	212
		BELLTREE	213
		CVICTUS	214
		EARTH SCIENCE ANALYTICS	216
		GETECH	217
		MICROSEISMIC	219
		NOV	220
		SERCEL	221
		SUSTEC	223

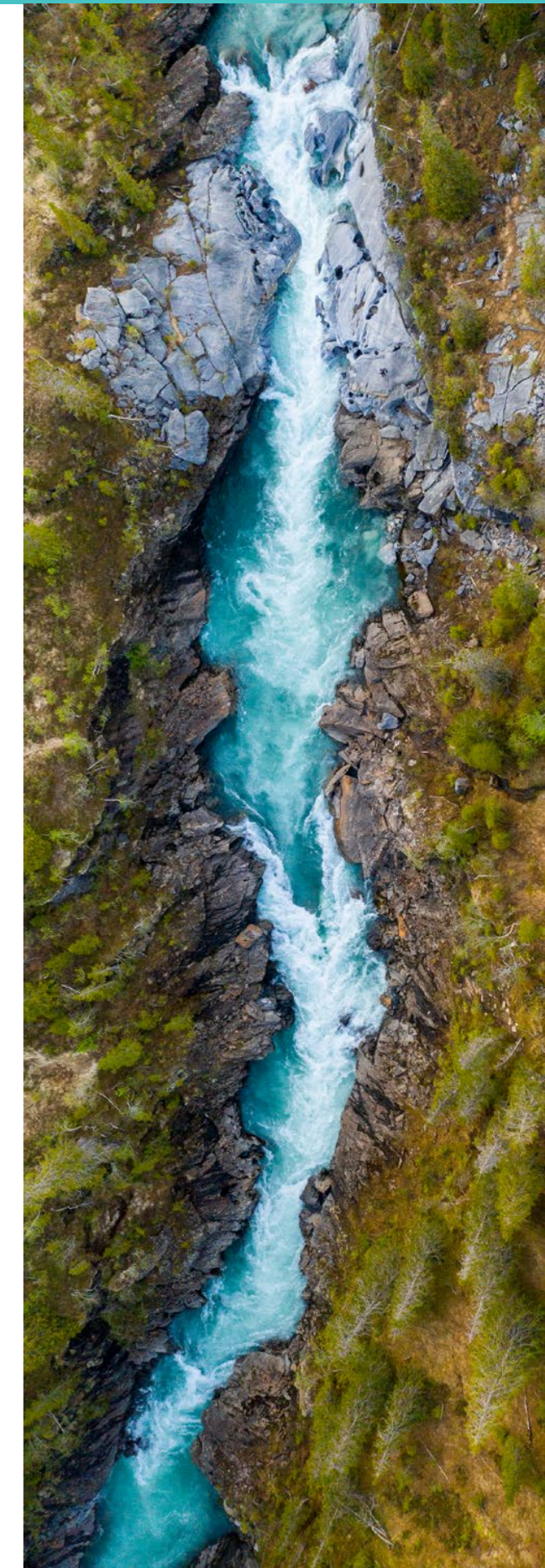

# TABLE OF SUBMITTERS

8RIVERS	12	FUELCELL ENERGY	76
AIR LIQUIDE	16	GETECH	217
AIRHIVE	147	HONEYWELL	78
ARDENT	148	INNOTECH ALBERTA	86
ASPENTECH - CAPTURE	149	ION CLEAN ENERGY	88
ASPENTECH - STORAGE	212	K2CO2	90
AXENS	24	KBR	158
B&W	26	KC8	92
BAKER HUGHES - CAPTURE	38	KNCC	170
BAKER HUGHES - STORAGE	162	KOBELCO	172
BAKER HUGHES - TRANSPORT	184	LEILAC	94
BASF	42	LINDE	96
BELLTREE	213	MANGROVE SYSTEMS	202
CAPSOL TECHNOLOGIES	44	MAXTUBE	174
CAPTIVATE	150	MICROSEISMIC	219
CAPTURA	151	NEBULA ENERGY	180
CARBFIX	196	NETPOWER	108
CARBON AMERICA	50	NIPPON STEEL	176
CARBON CLEAN	52	NOV - CAPTURE	110
CARBON ENGINEERING	54	NOV - STORAGE	220
CARBONCO	152	NOV - TRANSPORT	178
CARBONORO	153	NOVONESIS	118
C-CAPTURE	56	NUADA	120
CEOX	154	PETRONAS	122
CHINA ENERGY	58	QUORUM SOFTWARE	204
CO2CRC	60	SAIPEM - CAPTURE	124
COOL PLANET TECH	155	SAIPEM - STORAGE	210
CVICTUS	214	SERCEL	221
DELTA CLEANTECH	156	SHELL	126
DRIL-QUIP	168	SINOPEC	130
EARTH SCIENCE ANALYTICS	216	SLB AND AKER	134
ELESSENT CLEAN TECH	64	SOLATRON	181
EMERSON	66	SUMITOMO	136
ENTROPY	72	SUSTEC	223
EQUATIC	157	SVANTE	142
EXPRO	198	TECNICAS REUNIDAS	144
FLUOR	74	VALUE MARITIME	159



# FOREWORD

Carbon Capture and Storage (CCS) is a crucial tool in addressing global greenhouse gas emissions and tackling climate change. Urgent technological development, deployment, and scale-up of CCS technologies are necessary to meet our net-zero targets across industries such as cement, steel, chemicals, natural gas, and power generation. The uptake of CCS technologies must continue to accelerate to address emissions from these industries and more, alongside deployment of Carbon Dioxide Removal applications to remove CO<sub>2</sub> already present in the atmosphere.

This year's Technology Compendium continues the work of earlier editions, expanding upon technologies applicable to CCS with deeper insight on their performance and applications. Proven, established technologies used for many decades in various industries are represented, as well as emerging technologies that will drive further improvements in performance, system costs, and energy usage. The submissions to this Compendium cover a range of methods in capture, transport, and storage to enable the development of the full CCS value chain.

The Technology Compendium showcases the breadth and depth of CCS technology available for deployment today, as well as technology in the process of reaching full commercial readiness. This insight into the current CCS technological capabilities and what may lie ahead provides a view of the accelerating deployment of CCS across the globe to tackle climate change.

The Technology Team  
Global CCS Institute  
August 2024

## Acknowledgements

We are grateful for the contributions and support of all the Submitters who have contributed to this publication.

We are also grateful for the Members of the Global CCS Institute, whose Membership enables the Institute to develop catalytic thought leadership pieces, publications such as this Technology Compendium, our annual Global Status Report and a variety of other publications that can be found on [our website](#).

Thank you to Hugh Barlow and Shahrzad Shahi for their invaluable editing and coordination of this report.

Special mentions also go to Yi Wu, Xiaoliang Yang, Yasuo Murakami, Kazuko Miyashita, Hiroshi Nambo, Erin Billeri, Spencer Schecht, Jerrad Thomas, Bruno Gerrits, Dominic Rassool, Carlo Maccherini, Mohammad Abu Zahra, Maryem El Farsaoui, Sarah Hardman, Chris Consoli, Aishah Hatta, Mojtaba Seyyedi, Ruth Gebremedhin, Elena Leva, Wendy Wells, and many more across the Institute for their time, efforts, and care with developing this publication.



# EDITOR'S NOTES

The Global CCS Institute ("The Institute") is an international think tank whose mission is to accelerate the deployment of carbon capture and storage (CCS), a suite of technologies to tackle climate change and deliver climate neutrality.

The Institute produces the "State of the Art" Technology Compendium annually to provide a platform for technology owners and producers to share their products, and allow developers, proponents, and interested parties to discover the field's state-of-the-art offerings. This is in accordance with our mission to accelerate the deployment of CCS globally.

The Technology Compendium is a free-to-enter publication, and technology providers collaborate with the Institute to provide their information to the Technology Compendium for review and publication. The technologies present in the 2024 Technology Compendium represent a non-exhaustive picture of the overall landscape of CCS technologies. Where there has been no submission received for the 2024 Technology Compendium, there is no presence within the Compendium. The Institute is aware of other CCS technologies not mentioned in this Technology Compendium, established and emerging, and we are working for future editions to include these technologies.

**If you wish to make a submission for the next edition of the Technology Compendium, please contact us via [techcompendium@globalccsinstitute.com](mailto:techcompendium@globalccsinstitute.com).**

## Disclaimer

The Global CCS Institute has endeavoured to ensure the information in this publication is as accurate as possible. However, it does not guarantee that the information in this publication is totally reliable, accurate, or complete. Therefore, the information in this publication should not be relied upon when making an investment or commercial decision or provided to any third party without the written permission of the Global CCS Institute.

The Global CCS Institute has no responsibility for the persistence or accuracy of URLs to any external or third-party internet websites referred to in this publication and does not guarantee that any content on such websites is, or will remain, accurate or appropriate.

To the maximum extent permitted, the Global CCS Institute, its employees, and advisers accept no liability (including for negligence) for any use or reliance on the information in this publication, including any commercial or investment decisions made on the basis of information provided in this publication.

The Global CCS Institute has relied on the contributions of over 60 CCS technology providers to compile this publication. Any claims regarding technology performance are the responsibility of the company concerned and are not endorsed by the Global CCS Institute. Readers should confirm any details contained in this Compendium with the technology holder concerned.

## Technology Readiness Level (TRL)

In this publication, the TRL of various technologies has been reported as a part of the submission. The guidance provided to submitters for TRL assessment is provided in Table 1. For inclusion in the 2024 Technology Compendium, a Technology must have a TRL of 5 or above.

**Table 1: TRL Guidance Provided for 2024 Technology Compendium Submissions**

CATEGORY	TRL	DESCRIPTION
Demonstration	9	Normal Commercial Service
	8	Commercial demonstration, full-scale deployment in final form
	7	Sub-scale demonstration, fully functional prototype
Development	6	Fully integrated pilot tested in a relevant environment
	5	Sub-system validation in a relevant environment
	4	System validation in a laboratory environment
Research	3	Proof-of-concept tests, component level
	2	Formulation of the application
	1	Basic principles, observed, initial concept

Front Cover Image: CapsolGo® at EEW Energy from Waste plant in Hanover, Germany, image courtesy of Capsol Technologies.

Foreword Image: Twence CCU 100,000 TPA plant in Hengelo, The Netherlands, image courtesy of SLB and Aker Carbon Capture JV.

# CAPTURE





contact8r@8rivers.com

www.8rivers.com

**SUMMARY**

To meet global climate goals and support the transition to a Net Zero economy, the world needs clean, affordable, and scalable solutions for producing hydrogen. 8RH<sub>2</sub> is an ultra-low-carbon hydrogen production technology that cost-effectively captures greater than 99.5% of the CO<sub>2</sub> produced during the process. At the heart of 8RH<sub>2</sub> is 8 Rivers' proprietary CO<sub>2</sub> Convective Reformer (CCR), which leverages the company's decades of expertise in oxy-combustion and heat transfer to achieve breakthrough performance.

The 8RH<sub>2</sub> process works by combining the CCR with an Oxy-Combustor, which combusts tail gas and natural gas fuel with synthetic air made up of pure oxygen and CO<sub>2</sub>. This results in a high-temperature, high-purity CO<sub>2</sub> stream that provides the necessary heat for steam methane reforming in the CCR. By leveraging the energy in the tail gas, 8RH<sub>2</sub> achieves improved cycle thermal efficiency while avoiding the additional costs associated with back-end carbon capture systems.

**BENEFITS**

- Our hydrogen production technology has no direct emissions and achieves an ultra-low-carbon intensity that is 15-20% lower than state-of-the-art autothermal reforming with CCS (ATR+CCS).
- The capture of CO<sub>2</sub> is inherently built into the process design, capturing in excess of 99.5%, while avoiding the use of toxic chemicals or energy-intensive processes.
- Combines strengths of commercially proven hydrogen production processes to reliably deliver clean and affordable energy at scale.
- Utilisation of oxy-fired combustion of tail gas to provide heat of reforming and heat integration enables a highly efficient cycle boasting 5-7% thermal efficiency gains versus benchmark ATR+CCS.
- Combined, this results in 8RH<sub>2</sub> having an unrivalled levelised cost compared to all utility-scale hydrogen technology currently on the market.
- Easily integrates with ammonia loop technology to enable production of ultra-low-carbon ammonia, which can be traded as commodity or used for easier H<sub>2</sub> transportation.

**KEY DATA**

TRL	>5	Capture Rate Range (tpd)	~	Modular (Y/N)	Yes
Source CO <sub>2</sub> Purity Range	~	Energy Consumption (GJ/tCO <sub>2</sub> )	~	Capture Efficiency (%)	>99%
Number of Commercial Plants	~	Number of Pilot Plants	~		
Target Industries	Hydrogen, Ammonia/Fertiliser, Refining, Transportation Fuels, Coal Fuel Switching, Methanol, Oxo-alcohols				

**KEY PROJECTS**



In January 2024, 8 Rivers announced Cormorant Clean Energy, located in Port Arthur, Texas, will be the first deployment of the 8RH<sub>2</sub> technology.

Cormorant will produce 880,000 tonnes of ultra-low-carbon ammonia and capture more than 1.4 million tonnes per annum (Mtpa) of CO<sub>2</sub>.

The project is expected to bring in over \$1 billion in investment to the region and is expected to reach FID in late 2025 with construction commencing shortly thereafter.

8 Rivers is actively exploring future projects for the 8RH<sub>2</sub> technology to be deployed in the US and abroad.

**TECHNOLOGY DESCRIPTION**

In May 2023, 8 Rivers announced the development of 8RH<sub>2</sub>, an ultra-low-carbon hydrogen production process that cost effectively captures greater than 99.5% of the CO<sub>2</sub> produced. At the heart of the process is 8 Rivers' years of oxy-combustion experience and a proprietary CO<sub>2</sub> Convective Reformer (CCR) that 8 Rivers is jointly developing with Casale SA.

In contrast to conventional steam methane reforming, 8 Rivers technological breakthrough is in the powerful combination of Oxy-Fired Combustion with our proprietary heat exchanger reformer, the CCR.

The Oxy-Combustor is a pressurised combustion heater that combusts tail gas and natural gas fuel with synthetic air made up of pure oxygen and CO<sub>2</sub> diluent. What results is a high temperature CO<sub>2</sub> flue gas stream that has not been contaminated by the impurities in air, namely nitrogen, which complicates back-end CO<sub>2</sub> capture. This hot CO<sub>2</sub> flue gas stream needs water and oxygen removal and is then pipeline ready at high purity.

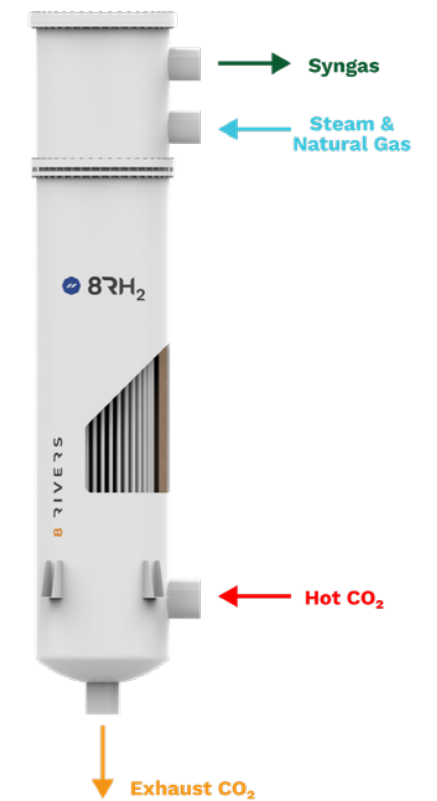
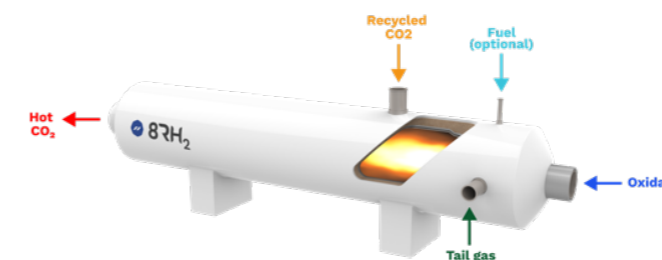

As its key output, 8RH<sub>2</sub> produces a stream of high-purity hydrogen. The remaining tail gas is separated to be recycled back to the Oxy-Combustor. 8RH<sub>2</sub> was designed to be easily integrated with ammonia loop technology.

8RH<sub>2</sub> technology utilises two distinct loops on each side of the process: hydrogen and CO<sub>2</sub>, to unlock greater than 99.5% CO<sub>2</sub> capture without sacrificing cost-effectiveness.

The first commercial deployment of the 8RH<sub>2</sub> technology will be Cormorant Clean Energy in Port Arthur Texas. Cormorant will produce 880,000 tonnes of ultra-low-carbon ammonia and capture more than 1.4 Mtpa of CO<sub>2</sub> annually.

In the 8RH<sub>2</sub> process, the hot CO<sub>2</sub> flue gas stream leaves the Oxy-Combustor and flows through the CCR, providing the heat necessary for steam methane reforming to occur. This allows 8RH<sub>2</sub> to leverage the energy contained in the tail gas fuel for the best purpose – creating more product, while keeping the CO<sub>2</sub> stream separate and pure.

Leveraging this tail gas energy, which is essentially a byproduct of steam methane reforming, in a useful, cost-effective manner and without contributing to emissions is one of the core advantages of 8RH<sub>2</sub> over traditional hydrogen production technologies.

Doing so enables improved cycle thermal efficiency while avoiding the additional costs associated with back-end carbon capture systems such as amine solvents.

After the CO<sub>2</sub> has provided heat to the CCR it will undergo further heat recovery before the Direct Contact Cooler removes water and cools the gas to pipeline ready temperatures. A portion of the CO<sub>2</sub> will be exported for sequestration, while the rest is recycled to act as a diluent in creating synthetic air for the Oxy-Combustor.

Feed gas leaves the CCR as partially reformed syngas and enters an Oxygen Secondary Reformer (OSR) which completes the reactions. A series of heat recovery, water gas shift reactions, and hydrogen purification operations are carried out, not unlike traditional hydrogen plants.





[contact8r@8rivers.com](mailto:contact8r@8rivers.com)

[www.8rivers.com](http://www.8rivers.com)

**SUMMARY**

As the world confronts climate change, experts agree that emissions reductions must be accompanied by large-scale carbon removal. Calcite, developed by 8 Rivers, uses the calcium cycle to rapidly remove CO<sub>2</sub> from the air. The Calcite carbon removal process works by accelerating the carbonation of calcium, passing ordinary air across calcium hydroxide in a warehouse to absorb CO<sub>2</sub> into calcium carbonate crystals. The calcium carbonate is then cycled into a kiln to regenerate calcium hydroxide and capture CO<sub>2</sub> for permanent sequestration. Calcite's low-cost approach, low technical risk, and hyper scalability make it a promising solution for global carbon removal needs.

8 Rivers and MIT developed Calcite's novel air contactor, which was validated by a prominent US National Laboratory. Calcite was a Milestone winner in the XPRIZE CDR competition, one of the Frontier Climate Fund's first offtakes, won DAC Hubs funding through the US DOE to support its commercial deployment, and was a winner of the DOE CDR Purchase Pilot Prize Phase 1.

**BENEFITS**

- The Calcite process is simple, leveraging the natural calcium cycle and does not require complicated catalysts or materials.
- Calcite is designed to be extremely scalable by using widely available equipment and existing supply chains as well as limestone, an abundant feedstock, which enables faster scale-up and progression to next-of-a-kind.
- Calcite offers durable carbon removal by permanently sequestering CO<sub>2</sub> geologically through highly regulated, Class VI wells, or through mineralising the CO<sub>2</sub> as limestone, CaCO<sub>3</sub>.



**KEY DATA**

TRL	6	Capture Rate Range (tpd)	~	Modular (Y/N)	~
Source CO <sub>2</sub> Purity Range	~	Energy Consumption (GJ/tCO <sub>2</sub> )	~	Capture Efficiency (%)	~
Number of Commercial Plants	~	Number of Pilot Plants	1		
Target Industries	DAC				

**TECHNOLOGY DESCRIPTION**

**THE CALCITE PROCESS**

Invented in 2019, Calcite is a cost-effective direct air capture technology to remove CO<sub>2</sub> directly from the ambient atmosphere. The process facilitates carbon removal by relying on the simplicity of the natural calcium cycle.

An oxy-fired kiln combusts fuel and concentrated oxygen to calcine fresh and regenerated calcium carbonate (CaCO<sub>3</sub>) to form calcium oxide (CaO), while the effluent CO<sub>2</sub> is captured for sequestration. Oxy-firing replaces the air normally used for fuel combustion with a mixture of high purity oxygen and CO<sub>2</sub>. The flue gas from oxy-fired process is almost entirely CO<sub>2</sub> and water, allowing it to be sent through a CO<sub>2</sub> compression and purification unit (CPU) for sequestration. An additional advantage of the oxy-fired kiln is that combusting fuel with carbon capture minimises the requirement for clean electricity for the facility.

Calcium oxide coming out of the kiln is then hydrated, which in turn carbonates with ambient air through air contactor modules. The air contactor is designed to facilitate fast carbonation when CO<sub>2</sub> from the ambient air reacts with the sorbent.

The last major step of the process is to deliver the newly formed calcium carbonate back into the oxy-fired kiln to separate the CO<sub>2</sub> for permanent sequestration. This creates a calcium loop to start a new carbonation cycle.

The technology is designed to facilitate fast carbonation with a high-capacity factor and little downtime. With simple chemistry and engineering, the Calcite process is set up to be a low cost, scalable, and quickly deployable system.

**THE CALCITE FACILITY**

A Calcite facility will consist of:

- 8 Rivers' novel air contractor where ambient CO<sub>2</sub> is passed over a calcium-based sorbent to form CaCO<sub>3</sub>;
- An oxy-fired calciner which uses thermal heat to decompose CaCO<sub>3</sub> into CO<sub>2</sub> for sequestration and CaO to be hydrated and cycled back to the air contactor;
- An oxygen production unit to supply oxygen to the oxy-calciner;
- Limestone storage and equipment to prepare the material to be fed to the oxy-calciner and material to be sent to market;
- CO<sub>2</sub> purification and compression equipment to prepare the captured CO<sub>2</sub> for pipeline transport.

**PROJECT STATUS**

Calcite is a member of the Southeast DAC (SEDAC) Hub, a deployment of DAC technologies in northern Mobile County, Alabama. Mobile County is an ideal location to support the initial phases of a DAC hub as it is home to many industrial facilities, large tracts of available land, and appropriate subsurface geology to support the creation of a sustainable CO<sub>2</sub>-based economy. In addition, numerous opportunities exist to employ the region's skilled workforce in pursuit of a variety of CO<sub>2</sub> use cases beyond permanent storage in subsurface reservoirs (e.g., CO<sub>2</sub> to fuels). Because of these attributes, the SEDAC Hub will not only abate local emissions but also lead to the development of a carbon reduction ecosystem in the area and the Gulf South more broadly.

As a recipient of funding under the U.S. Department of Energy's Direct Air Capture (DAC) Hub program, a FEED study will be conducted to support the construction and operation of a 100,000 net tonne per year Calcite carbon removal facility as a part of the SEDAC Hub.

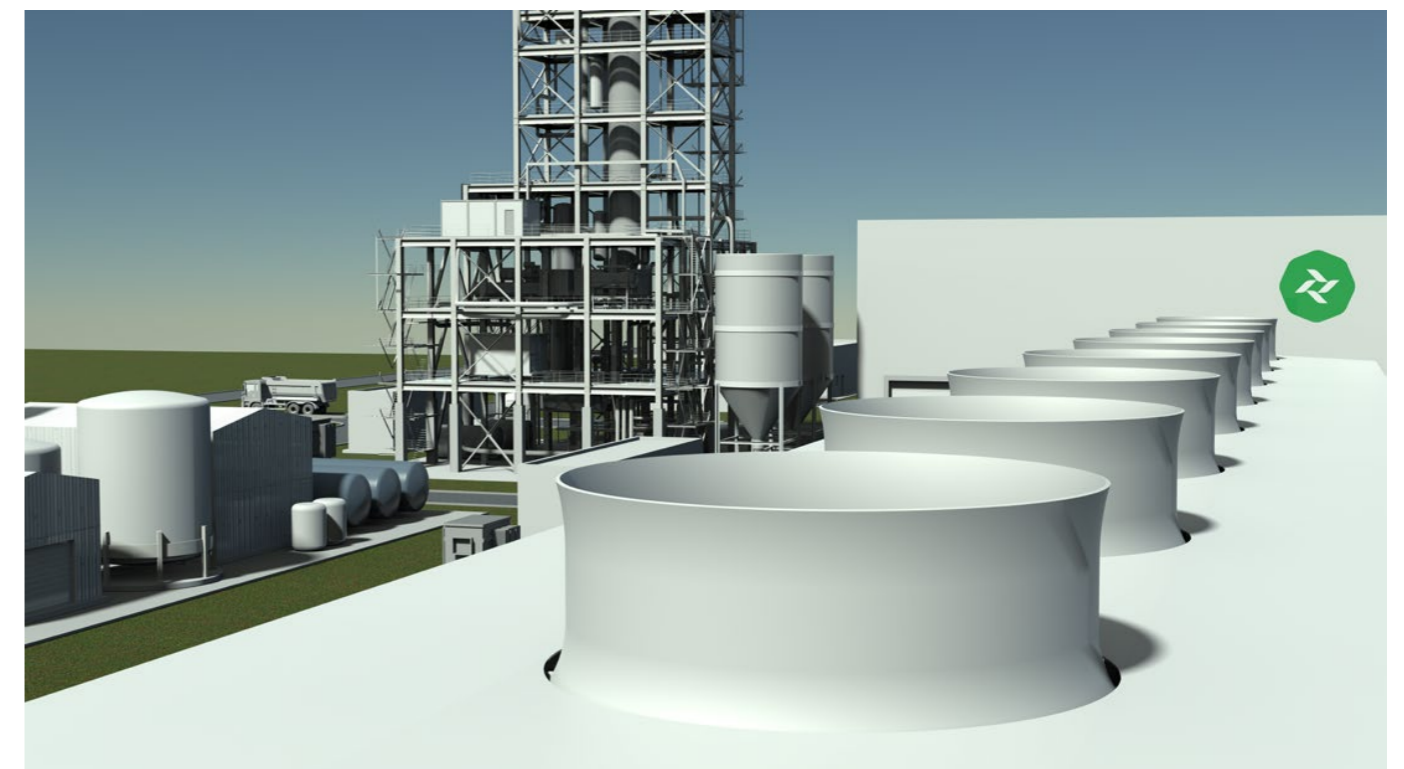



# CHEMICAL ABSORPTION – FLUE GAS AND SYNGAS



[gas-treatment@airliquide.com](mailto:gas-treatment@airliquide.com)

[hydrogen-syngas@airliquide.com](mailto:hydrogen-syngas@airliquide.com)

## SUMMARY

Air Liquide has considerable experience in designing optimised chemical solvent based technologies to capture CO<sub>2</sub> and/or other contaminants from synthesis gas or flue gas. Through long term partnerships with key solvent providers, Air Liquide has designed and installed more than 85 units worldwide and benefits from its long-term operational experience on amine units. Considered as a state-of-the-art solution for CO<sub>2</sub> capture, amine technology can remove CO<sub>2</sub> efficiently from a wide variety of gases.

## BENEFITS

- Fully referenced in all applicable scales and different applications
- Process uses inexpensive, available and chemically stable solvent
- Technology provides low operating costs and high reliability
- Process configuration can be tailored to optimise Capex and Opex

## KEY DATA

TRL	8-9	Capture Rate Range (tpd)	150 - 5,000	Modular (Y/N)	Yes
Source CO <sub>2</sub> Purity Range	1-35%	Energy Consumption (GJ/tCO <sub>2</sub> )	1-2.8 (heat)	Capture Efficiency (%)	99%+
Number of Commercial Plants	85+				
Target Industries	<ul style="list-style-type: none"> <li>• Flue Gas: SMR, Boilers, Fired heaters, Waste incineration, Refineries (FCC), BECCS, Power plant, Pulp &amp; paper</li> <li>• Syngas: H<sub>2</sub> production (SMR, POX, ATR) &amp; Syngas with ~15% to 35% CO<sub>2</sub>. Oxo-syngas with 3% to 15% CO<sub>2</sub></li> </ul>				

## TECHNOLOGY DESCRIPTION

### SYNGAS AMINE WASH

Air Liquides Syngas Amine Wash technology offers highly energy-efficient processes such as BASF OASE® white. The process configuration is tailored according to treated gas requirements and CO<sub>2</sub> product specification as well as optimised Capex and Opex. The process can be heat-integrated with the upstream gas generation. CO<sub>2</sub> specifications in the treated gas < 20 ppm are achievable, making this process ideal for CO<sub>2</sub> removal upstream of any coldbox or ammonia process. CO<sub>2</sub> capture rates from syngas of >99% can be achieved to produce a decarbonised hydrogen product.

Characteristics:

- 99.7% availability
- CO<sub>2</sub> at up to 2.3 bara, purity of up to 99.9%"

### FLUE GAS AMINE WASH

The Flue Gas Amine Wash technology is an energy efficient solution using highly stable, low maintenance solvents based on proprietary second generation amines such as BASF's OASE® blue. CO<sub>2</sub> capture rates of up to 99% can be achieved irrespective of the feed's CO<sub>2</sub> content, and a CO<sub>2</sub> product specification of up to >99.9% can be reached. Up to 1,500,000 Nm<sup>3</sup>/h of flue gas or 5,000 tpd CO<sub>2</sub> can be treated in a single train. Trace components such as particles and SO<sub>x</sub> are handled in the upstream pretreatment. The required heat duty can be provided by LP Steam or thermal oil. Heat integration with upstream units is also an option.

Characteristics:

- Up to 16% O<sub>2</sub> in flue gas tested
- 99.7% availability
- CO<sub>2</sub> purity of up to 99.9% and low O<sub>2</sub>, at up to 2.5 bara w/o compression Particles & SO<sub>x</sub> handled upstream of amine wash

Main Applications: Flue gases or off gases from industrial sources with CO<sub>2</sub> content 3% to 25% - (SMR, cement/lime, steel blast furnace, refineries (FCC), biomass power plant, pulp & paper)

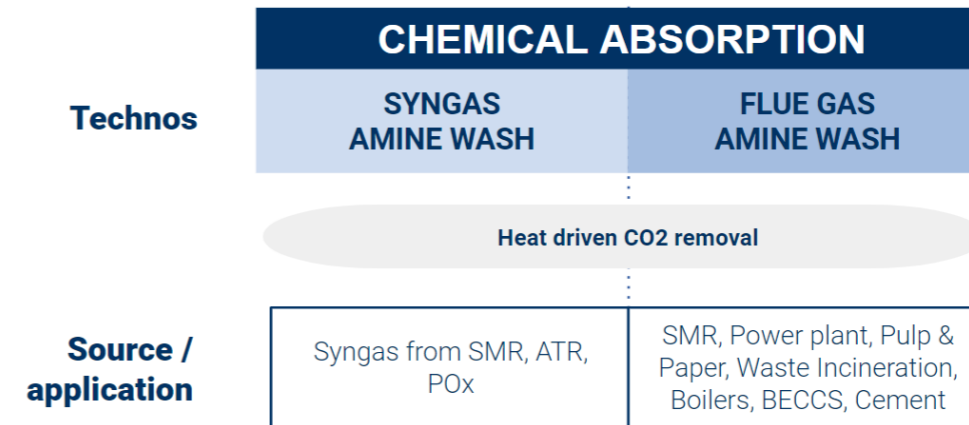



# CRYOCAP™ (H<sub>2</sub>, FG, OXY & STEEL)



[cryocap@airliquide.com](mailto:cryocap@airliquide.com)

[www.engineering.airliquide.com](http://www.engineering.airliquide.com)

## SUMMARY

Air Liquide has developed Cryocap™, a patented technology that uses cryogenic processes to capture CO<sub>2</sub>. Being a combination of various Air Liquide proprietary technologies, Cryocap™ can be adapted to various applications and has the potential to not only reduce the CO<sub>2</sub> emissions by up to 99% but also to recover other valuable molecules such as H<sub>2</sub>, CO, and CH<sub>4</sub> from the feed gas. To date, Cryocap™ is the only operational full-scale cryogenic carbon capture technology with an industrial reference (Port Jerome, France) in the CCS market worldwide. For over 8 years, the Port Jerome site has demonstrated steady operation and performance parameters, no interruptions in the H<sub>2</sub> production, and a CO<sub>2</sub> availability of more than 99%+.

## BENEFITS

- Minimised overall carbon footprint: high CO<sub>2</sub> recovery (92 - 99%+)
- High intrinsic process efficiency: most efficient technology bricks and operation close to triple point
- Safety and no toxicity: no by-product formation, solvent-free, no toxic or flammable gases used
- Matches the end specifications and high CO<sub>2</sub> product purity: meeting stringent CO<sub>2</sub> specifications (>99.9%v)
- Favours synergies and optimised space: 1-step capture and liquefaction, compact design & flexible configuration
- Improved productivity: for some applications (H<sub>2</sub> and steel), H<sub>2</sub> production can be increased by up to 20%
- HSE friendly
- Skidded: main equipment delivered skidded for lower installation cost

## Air Liquide Cryocap™ references

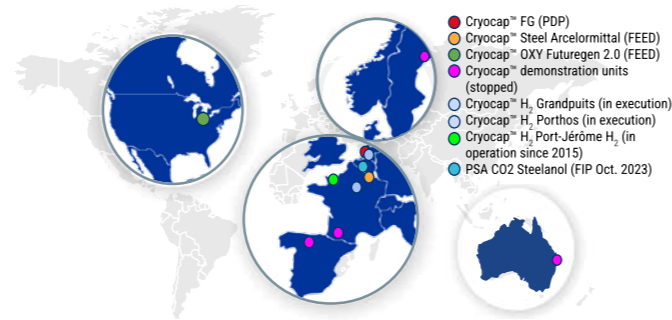

## KEY DATA

TRL	6 - 8	Capture Rate Range (tpd)	300 – 10,000+	Modular (Y/N)	Yes
Source CO <sub>2</sub> Purity Range	15-95%v	Energy Consumption (GJ/tCO <sub>2</sub> )	0.4 – 2	Capture Efficiency (%)	Up to 99%+
Number of Commercial Plants	2	Number of Pilot Plants	4		

### Target Industries

- H<sub>2</sub>: H<sub>2</sub> production (SMR or ATR)
- FG: Flue gases or off-gases with CO<sub>2</sub> content >= 15% (SMR, cement/lime, steel blast furnace, refineries (FCC), waste incineration/biomass power plant, pulp & paper)
- Oxy: Cement/Lime, Power plant, any applications with CO<sub>2</sub> concentration >50%
- Steel: Iron and Steel Production

## TECHNOLOGY DESCRIPTION

### CRYOCAP™ H<sub>2</sub>

Cryocap™H<sub>2</sub> uses cryogenic purification to separate the CO<sub>2</sub> from the Pressure Swing Adsorption (PSA) off-gas, containing typically 40-70+%v CO<sub>2</sub>. The PSA off-gas is compressed, dried and sent to a cryogenic unit, where the CO<sub>2</sub> is separated from the other components by a combination of partial condensation and distillation. A pure liquid CO<sub>2</sub> flow is produced from the cold process. The non-condensed gases are recycled through a membrane system to recover H<sub>2</sub> and CO<sub>2</sub>. The residual gas, composed of CO and CH<sub>4</sub>, is recycled to the H<sub>2</sub> production plant either as feedstock or as fuel gas. The CO<sub>2</sub> product is either re-vaporised to be then compressed up to the final pressure (gaseous or supercritical product) or extracted in liquid state.

#### Characteristics:

- Opex + Capex: 30-50 €/tCO<sub>2</sub> captured
- Avoided CO<sub>2</sub> cost reduction: up to 40% compared to MDEA
- Hydrogen extra production: of + 12-20%

### CRYOCAP™ FG

Cryocap™FG is a separation process based on the combination of adsorption and cryogenic separation. The flue gas is first compressed, dried and sent to a PSA (Pressure Swing Adsorption). The PSA pre-concentrates the CO<sub>2</sub> in the off-gas, which is then compressed and sent to a cold process. There, the CO<sub>2</sub> is separated from the other PSA off-gas components and purified by a combination of partial condensation and distillation. Part of the impurities removed in the cryogenic process are recycled to the inlet of the plant. The CO<sub>2</sub> product is either compressed up to the final pressure (gaseous or supercritical product) or recondensed and extracted in liquid state. The pressurised nitrogen from the PSA is expanded to recover energy.

#### Characteristics:

- 40 to 80 €/tCO<sub>2</sub> captured,
- PSA-assisted CO<sub>2</sub> condensation
- Smart impurities management (including NO<sub>x</sub> removal)

### CRYOCAP™ OXY

Cryocap™Oxy uses oxy-fuel combustion exhaust as a feedstock. The flue gas issued from the cement or lime or power plant is first treated in a pre-treatment unit, which aims to cool the gas and remove the SO<sub>x</sub>, HF, HCl, part of the NO<sub>x</sub>, and dust. Then, the gas is compressed and dried before entering the cryogenic purification unit. In the cold section, CO<sub>2</sub> is recovered and purified by a combination of partial condensation and distillation, with both light and heavy components (O<sub>2</sub>, Ar, CO, N<sub>2</sub>, remaining NO<sub>x</sub>) being removed from the CO<sub>2</sub> down to ppmv or sub ppmv level. The purified CO<sub>2</sub> can be produced either gaseous and then compressed to the final pressure, or produced directly as liquid.

#### Characteristics:

- 30 - 50 €/tCO<sub>2</sub> captured
- Enriched flue gas above 50% CO<sub>2</sub>
- Smart impurities management (including NO<sub>x</sub> removal)

### CRYOCAP™ STEEL

Cryocap™Steel was designed to specifically capture CO<sub>2</sub> from steel making plants with flue gases containing CO<sub>2</sub> in the 20-50% range. The gas is first compressed, dried and sent to a PSA (Pressure Swing Adsorption). The PSA pre-concentrates the CO<sub>2</sub> in the off-gas while producing a CO rich stream. The pre-concentrated CO<sub>2</sub> stream is compressed and sent to a cold process. There, CO<sub>2</sub> is recovered and purified by a combination of partial condensation and distillation, with both light and heavy components (NO<sub>x</sub>, O<sub>2</sub>, Ar, CO, N<sub>2</sub>) being removed from the CO<sub>2</sub> down to ppmv or sub ppmv level. The purified CO<sub>2</sub> can be produced either gaseous and then compressed to the final pressure, or produced directly as liquid. The pressurised CO-rich stream from the PSA unit is either recycled to the blast furnace or used to produce fuels.

#### Characteristics:

- Compact and flexible footprint: compressors, PSA and cold-box can be located in three different plots
- 25-60 €/t CO<sub>2</sub> captured

## Air Liquide cryogenic offerings for CO<sub>2</sub> capture and liquefaction

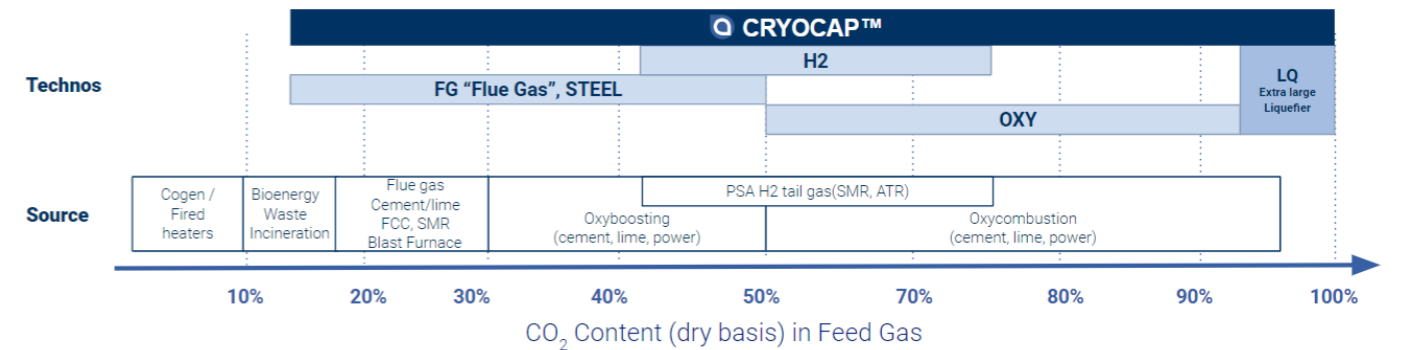



**AIR LIQUIDE**

**CRYOCAP™ LQ (EXTRA LARGE CO<sub>2</sub> LIQUEFIER)**



**SUMMARY**

Air Liquide has developed Cryocap™ LQ, specifically designed to liquefy large volumes of CO<sub>2</sub>. The solution allows the aggregation of CO<sub>2</sub> from various emitters utilising possibly different types of carbon capture technologies. On top of liquefying CO<sub>2</sub>, Cryocap™ LQ also allows the removal of moisture and other compounds (such as O<sub>2</sub>) to meet CO<sub>2</sub> sink specifications. The technology is able to reduce specific energy consumption throughout the process by 40% compared to traditional industrial CO<sub>2</sub> liquefaction processes, while ensuring very high CO<sub>2</sub> recovery. The technology is especially suited for CO<sub>2</sub> industrial hubs and basins where the CO<sub>2</sub> needs to be transported via ships, trucks, or trains. Cryocap™ LQ is a chemical free, HSE-friendly solution. As a single compressor is used for both the feed and the cycle, it is also a very compact and cost effective solution.

**BENEFITS**

- Large scale capacities
- HSE-Friendly
- Highly compact and flexible design
- High recovery and lower specific energy consumption
- Single centrifugal compressor (1 machine for CO<sub>2</sub> compression and refrigeration cycle)

**KEY PROJECTS**

- 2022/2023 - Industrial pre-FEED and FEED for 7000 tpd in Belgium (Antwerp@C)
- 2023/2024 - Industrial pre-FEED and FEED for 3700 tpd in France (Dartagnan)
- 2024 - Industrial FEED for 3500 tpd in Sweden (Stockholm Exergi)

**KEY DATA**

TRL	7	Capture Rate Range (tpd)	700 - 10,000+	Modular (Y/N)	Yes
Source CO <sub>2</sub> Purity Range	95%v+	Energy Consumption (GJ/tCO <sub>2</sub> )	0.2 - 0.5	Capture Efficiency (%)	97%+
Number of Commercial Plants	~	Number of Pilot Plants	~		
Target Industries	CO <sub>2</sub> Liquefaction				

**TECHNOLOGY DESCRIPTION**

**CRYOCAP™ LQ**

The Cryocap™ LQ process is proposed as an industrial solution to compress, liquefy, and purify the raw CO<sub>2</sub> stream resulting from upstream units. The CO<sub>2</sub> feed gas is compressed in the feed/recycle compressor, dried at an intermediate pressure and then compressed again. The compressed gas is cooled down and then routed to the cold process. In the cold process, the high-pressure, dry CO<sub>2</sub> is cooled down and split into various streams.

One of these streams is purified by distillation in the Stripping Column to produce the liquid CO<sub>2</sub> product, which is routed to the unit's battery limits. The remaining streams are expanded to different levels and vaporised in the main heat exchanger, providing the refrigeration load required for the liquefaction of the CO<sub>2</sub>. Once vaporized, these streams are recycled at ambient temperature to the feed/recycle compressor. This configuration makes it possible to handle the compression of the feed gas and the refrigeration with a single compressor (so called self-refrigerated cycle).

**Characteristics:**

- Very low OpEx
- HSE friendly
- From low pressure to high pressure CO<sub>2</sub> product
- Liquefies CO<sub>2</sub> at ambient temperature
- 5-25 €/tCO<sub>2</sub> liquefied

**Air Liquide cryogenic offerings for CO<sub>2</sub> capture and liquefaction**

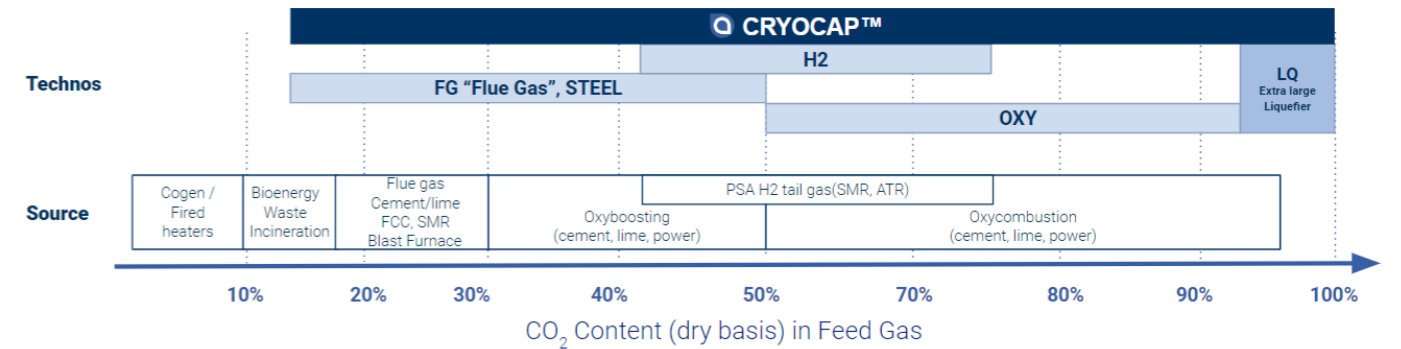



# PHYSICAL ABSORPTION - RECTISOL™ AND RECTICAP™



hydrogen-syngas@airliquide.com

gas-treatment@airliquide.com

## SUMMARY

Air Liquide's Rectisol™ and Recticap™ state-of-the-art physical absorption technologies use cold methanol to remove acid gases and CO<sub>2</sub> from feed gas. Air Liquide draws on its extensive experience and technological expertise from the operation of multiple Rectisol units, more than 110 units installed worldwide, and a demonstration plant, to test and implement new innovations.

## BENEFITS

- One of the highest energy efficiencies for removal of CO<sub>2</sub> and/or acid gases (H<sub>2</sub>S, COS, etc.)
- Rectisol™ can treat the most severe impurities that stem from gasification, and deliver ultra high purity syngas for downstream catalytic applications such as the production of Sustainable Aviation Fuels
- Recticap™ delivers one of the highest energy efficiencies for CO<sub>2</sub> removal on low carbon H<sub>2</sub> or NH<sub>3</sub> applications
- More than 110 references worldwide, and know-how from AL's own operated plants and demonstration unit

		PHYSICAL ABSORPTION	
		RECTICAP™	RECTISOL™
<b>Technos</b>			
		Highest efficiency - adapted to large scale low-carbon syngas applications	
<b>Source / application</b>		Low-carbon H <sub>2</sub> or NH <sub>3</sub> Production	Biomass / MSW gasification for H <sub>2</sub> , MeOH, SAF Production

## KEY DATA

TRL	9	Capture Rate Range (tpd)	1,000 - 10,000	Modular (Y/N)	Yes
Source CO <sub>2</sub> Purity Range	20-30%	Energy Consumption (GJ/tCO <sub>2</sub> )	0.2 GJ/tCO <sub>2</sub> (elec) + 0.1 GJ/tCO <sub>2</sub> (heat)	Capture Efficiency (%)	Up to 99%
Number of Commercial Plants	110+	Number of Pilot Plants	1		
Target Industries	Rectisol™ <ul style="list-style-type: none"> <li>• Biomass-based / MSW-based gasification for the production of Sustainable Aviation Fuels (SAF) / H<sub>2</sub> / MeOH / NH<sub>3</sub></li> <li>• Coal-based applications such as IGCC, Chemicals</li> </ul> Recticap™ <ul style="list-style-type: none"> <li>• Carbon capture &amp; Syngas bulk CO<sub>2</sub> removal for production of decarbonised hydrogen and ammonia/urea from NG</li> </ul>				

## TECHNOLOGY DESCRIPTION

### RECTISOL™

Harmful acid gases contained in raw gases from gasification are removed by absorption with a physical solvent (cold methanol). Rectisol™ is the leading process when it comes to the purification of gasification-based syngas for hydrogen production, catalytic applications (production of syngas, methanol, ammonia, or Fischer-Tropsch), or syngas for power production. Using an energy efficient solvent in combination with optimised heat integration, the Rectisol™ process has extremely low operating costs and high availability. Various configurations are possible, to optimise the capital intensity or energy consumption in accordance with the project or client's conditions.

- CO<sub>2</sub> removal rate: down to 5 ppm
- Sulphur (H<sub>2</sub>S + COS): < 0.08 ppm
- Special setups for removal of mercaptans, metal carbonyls and BTX available
- All harmful contaminants within the acid gas can be safely processed in a SRU

### RECTICAP™

Recticap™ is a streamlined Rectisol™ concept optimised for CO<sub>2</sub> removal from ATR based applications such as low carbon H<sub>2</sub> or NH<sub>3</sub>. The process has been tailored for CO<sub>2</sub> capture at large capacities (>300,000 kNm<sup>3</sup>/hr syngas) and moderate to high pressures (>25 bar). Recticap™ removes only CO<sub>2</sub> from the raw hydrogen / syngas, thus combining the efficiency of the Rectisol™ process with reduced capital expenditures. The technology allows for capture rates in excess of 99% from syngas. Dry CO<sub>2</sub> capture-ready at >99% purity is achievable. Various configurations are possible for project-specific optimisation of energy demand and CO<sub>2</sub> capture performance.

- Highest energy efficiency for CO<sub>2</sub> removal
- High availability: 99.7%



[nadege.guernaec@axens.net](mailto:nadege.guernaec@axens.net)

[www.axens.net](http://www.axens.net)

**SUMMARY**

Building on 60 years of experience and continuous innovation, Axens provides CO<sub>2</sub> capture solutions as well as a comprehensive suite of flue gas pre-treatments and CO<sub>2</sub> conditioning processes. To address challenges of capturing CO<sub>2</sub> from flue gases, Axens and IFPEN developed the DMX™ process, a breakthrough CO<sub>2</sub> post-combustion capture process based on absorption using a proprietary demixing solvent.

The DMX™ solvent consists of a mixture of two organic compounds in aqueous solution, which is demixing under certain conditions of temperature and CO<sub>2</sub> partial pressure in the regeneration section. The DMX™ solvent is regenerable with a much higher capacity than available solvents, whereas only the CO<sub>2</sub>-rich phase needs to be regenerated.

The DMX™ Technology has been successfully demonstrated through a large-demonstration plant at ArcelorMittal's steel mill in Dunkirk and has reached a TRL of 8.

**BENEFITS**

Main benefits of DMX™ process are the following:

- Versatile and flexible process applicable to multiple types of flue gases origins, composition and flowrate.
- Low energy consumption.
- Thermally stable solvent with low degradation.
- High capture rate (up to 99%) and high purity of produced CO<sub>2</sub> (>99.5%).
- CO<sub>2</sub> produced readily under pressure up to 5 barg for significant compression cost-savings.
- 30% reduction of CO<sub>2</sub> capture cost compared to MEA based technologies.
- Customised design fitting the site, operational and available utilities constraints.
- Available for a wide range of unit sizes (stick built or Modular).
- Support on the full value chain: pre-treatment, capture, conditioning and close collaboration with EPCs and compressor vendors for integrated offer.
- Continuous innovation and testing capabilities at IFPEN facilities.

**KEY DATA**

TRL	8	Capture Rate Range (tpd)	From Pilot, to tailor made Large scale unit	Modular (Y/N)	Yes
Source CO <sub>2</sub> Purity Range	3-30% typical	Energy Consumption (GJ/tCO <sub>2</sub> )	2.0-2.7 Typical heat req.	Capture Efficiency (%)	90 - 99%
Number of Commercial Plants	1	Number of Pilot Plants	1		
Target Industries	Applicable to multiple emitters types: Power generation, Steel mills, Refineries, waste incinerators as well as chemical, cement, lime, glass, paper, aluminium production plants				

**TECHNOLOGY DESCRIPTION**

**PRECONDITIONING SECTION**

Upstream of the carbon capture process a dedicated preconditioning section shall be foreseen to cool down the Flue gases, optimise the Heat Recovery, overcome the pressure drop across the Carbon Capture Unit and remove the dust and the impurities such as SO<sub>x</sub> and NO<sub>x</sub> if present in high quantities. Axens, with its Danish subsidiary Flowvision offers technologies to address all these pollutants.

Relying on this know-how, and its DMX™ solvent highly tolerant to flue gas impurities, including O<sub>2</sub>, particulates, and acid gases such as NO<sub>x</sub> and SO<sub>x</sub>, Axens is capable of supplying a fully integrated and optimised pre-conditioning section tailored to each specific application.

**CARBON CAPTURE PROCESS DESCRIPTION**

The DMX™ process, originally developed for CO<sub>2</sub> capture on coal power stations flue gases and steel mill gas is also applicable to capture CO<sub>2</sub> from industrial emitters such as refineries, lime producers, waste incinerators as well as chemical, cement, glass, paper or aluminium production plants.

The DMX™ solvent removes CO<sub>2</sub> from the flue gas in the absorber to achieve a CO<sub>2</sub> recovery of 90 - 99% depending on the needs.

The CO<sub>2</sub>-rich solvent is preheated in the lean/rich solvent exchanger to reach conditions at which the solvent forms two phases: one CO<sub>2</sub>-rich phase and the other, CO<sub>2</sub>-lean phase.

The CO<sub>2</sub>-lean phase is separated in the decanter and directly routed back to the absorber. Only the CO<sub>2</sub>-rich phase is regenerated.

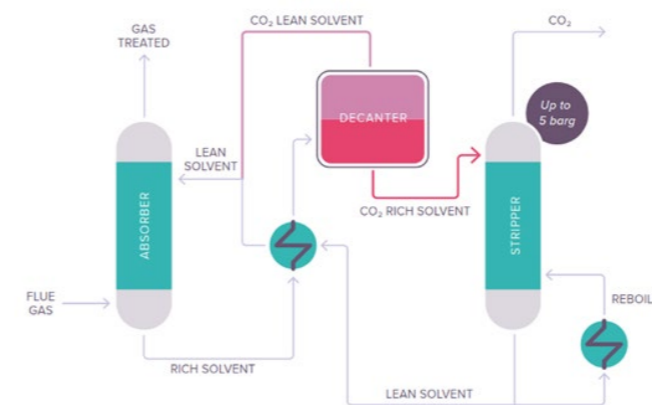

Figure 1: DMX™ Process Concept & PFD

The required reboiler steam consumption is greatly reduced thanks to this feature, associated to the solvent's high capacity.

The regeneration of the CO<sub>2</sub>-rich phase is performed under pressure, up to 5 barg, thanks to its thermal stability, enabling the process to achieve significant CO<sub>2</sub> compression-related cost-savings in view of its sequestration or liquefaction.

Low steam energy consumption at the reboiler can be achieved, varying typically in the range of 2.0-2.7 GJ/tCO<sub>2</sub>, depending on the CO<sub>2</sub> concentration of the flue gases and the targeted capture rate. This energy penalty can be further reduced with electrification of the process, valorisation of waste heat and optimised heat integration with the site environment.

**DEVELOPMENT AND TECHNOLOGY READINESS LEVEL**

The DMX™ process has undergone more than 10 years of development from laboratory scale to demonstration level. The technology has been successfully demonstrated through a large-pilot plant at ArcelorMittal steel mill in Dunkirk capturing the CO<sub>2</sub> from a blast furnace gas at a capacity of 0.5t CO<sub>2</sub>/h.

The DMX™ demonstration unit was built and has been operated with a 24/7 operation since April 2023 within the European H2020 "3D" project bringing together 11 European partners including ArcelorMittal, Axens, IFPEN and TotalEnergies (Grant Agreement N° 838031).

Additional information is available at the following address <https://3d-ccus.com/>

3D unit has demonstrated several key aspects of the DMX™ technology, such as process operability, good solvent stability (no degradation observed), low energy consumption and purity of the captured CO<sub>2</sub> for a wide range of CO<sub>2</sub> concentrations.

Based on those results, the DMX™ technology has now reached a TRL of 8.

IFPEN and Axens continue to work on the development of future generations of increasingly efficient DMX™ solvents, as well as other innovative CO<sub>2</sub> capture solutions.

**CO<sub>2</sub> CONDITIONING**

The purification of the captured CO<sub>2</sub> plays a critical role in enabling its safe and efficient transport, utilisation or permanent storage.

Most common impurities are sulphur compounds, oxygen and water but other contaminants such as mercury or chloride may also be encountered.

Axens offers a complete portfolio based on its own products (catalysts and adsorbents) and technologies to remove contaminants present in the CO<sub>2</sub> and make sure that the specifications are met.

Our wide range of solutions, know-how in process design and our ability to work in close collaboration with compressor suppliers ensure an optimum design of the CO<sub>2</sub> conditioning chain for each project.

# BRIGHTLOOP™ LOW-CARBON INTENSITY HYDROGEN PRODUCTION



## SUMMARY

Babcock & Wilcox partnered with The Ohio State University to develop our BrightLoop chemical looping technology, which can use a variety of fuel stocks to produce hydrogen, syngas, steam, liquid fuel or methanol, and/or power while also producing a stream of concentrated CO<sub>2</sub> for sequestration and storage or other uses.

The patented BrightLoop process is based on the oxidation and reduction of an iron-based oxygen carrier particle and can produce separated streams of hydrogen and CO<sub>2</sub> from gas and solid fuels – including biomass, coal, waste fuels, natural gas, biogas, petroleum coke (petcoke) or others. In this process, fuel reacts with the oxygen-carrier particles in a fuel reactor, forming combustion byproducts, predominantly CO<sub>2</sub>, while reducing the oxygen-carrier particles. The reduced oxygen-carrier particles then move to a hydrogen reactor where they react with steam to partially oxidise the particles and generate a stream of hydrogen.

The oxygen-carrier particles are then transported to an air reactor where they are regenerated with air back to their original state. The fuel and hydrogen reactors use moving bed technology while the air reactor uses fluidised-bed technology, both well-proven technologies with which B&W has extensive experience. Other emissions can be controlled using B&W's complete suite of environmental control technologies.

## BENEFITS

- Hydrogen from solid fuels – can utilise a variety of solid or gaseous fuels as feedstock.
- High rate of carbon captured – inherent CO<sub>2</sub> isolation supports sequestration or utilisation without the expensive post combustion capture equipment and operation.
- Competitive hydrogen cost – lower levelised cost of hydrogen when compared to other hydrogen production methods.
- High quality hydrogen – production from steam produces higher quality as compared to separating hydrogen from fuel.
- Scalable for a range of applications – accommodates both large and small applications.

## KEY DATA

TRL	6	Capture Rate Range (tpd)	~	Modular (Y/N)	Yes
Source CO <sub>2</sub> Purity Range	~	Energy Consumption (GJ/tCO <sub>2</sub> )	~	Capture Efficiency (%)	~
Number of Commercial Plants	~	Number of Pilot Plants	~		
Target Industries	Oil & Gas, Refineries, Power Utilities, Iron & Steel, any medium to heavy industrial facility				

## TECHNOLOGY DESCRIPTION

### CLIMATEBRIGHT™ - SUITE OF REVOLUTIONARY HYDROGEN AND DECARBONISATION TECHNOLOGIES FROM BABCOCK & WILCOX (B&W)

B&W's ClimateBright™ decarbonisation technologies are designed to help customers in energy and industrial sectors aggressively combat greenhouse gas emissions and climate change. ClimateBright technologies further strengthen B&W's commitment to clean energy progress and to helping customers worldwide address the most significant environmental challenges in industrial processes and energy generation.

ClimateBright has a wide range of clean energy solutions to drive the energy transition through carbon capture and production of hydrogen for industries including energy production, food manufacturing, steel, cement, oil and gas, pharmaceutical, petrochemical, carbon black, and pulp and paper. Our technologies build on B&W's core talents in steam generation, combustion, and flue gas treatment, and each addresses the emissions of carbon dioxide (CO<sub>2</sub>) from the combustion of carbon-based fuels in a unique way:

1. BrightLoop™ uses a chemical looping process around a ferrous oxygen carrier to separate the products of combustion of a carbon-based fuel into separate streams of CO<sub>2</sub> and oxygen depleted air, allowing for the capture of CO<sub>2</sub>.
2. SolveBright™ is a post-combustion capture process using regenerable solvents.
3. OxyBright™ utilises nearly pure oxygen in the combustion process while purifying the flue gas stream to near pure CO<sub>2</sub>, simplifying its capture.
4. BrightGen™ eliminates/reduces the generation of CO<sub>2</sub> by switching to a non- or low-carbon-based fuel.
5. Flue gas pre-treatment to optimise post-combustion CO<sub>2</sub> capture.

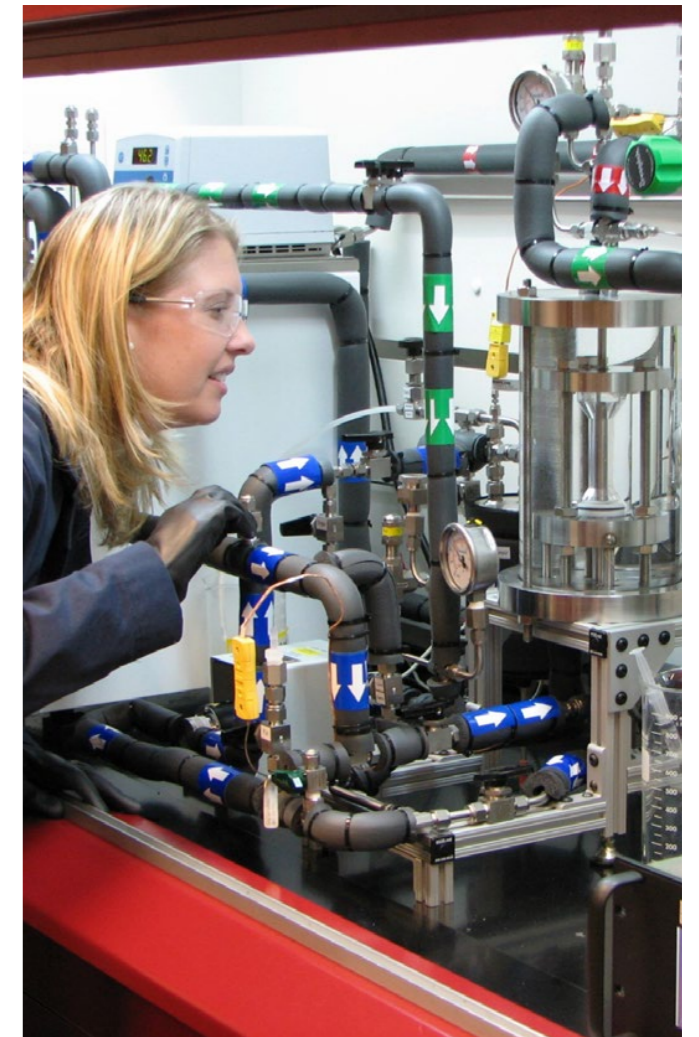



marketing@babcock.com

www.babcock.com

**SUMMARY**

B&W's BrightGen hydrogen combustion solution is currently in operation in more than 60 industrial boilers around the world, including at multiple refineries and other industrial facilities and is available to customers seeking a powerful hydrogen combustion solution for utility and industrial applications where efficient, zero-carbon dioxide-emissions energy generation is a goal.

Our highly reliable utility, industrial and package boilers can be manufactured or retrofitted with BrightGen technology to safely burn hydrogen or hydrogen-blended fuels for virtually any need, including power, heating and steam generation, and for industrial applications such as refineries and petrochemical facilities.

When considering the potential for fuel switching from a solid or gaseous fuel, and integrating hydrogen into the combustion process, B&W conducts a complete evaluation of the entire boiler system. This includes all combustion equipment such as burners, burner management systems, boiler pressure parts, ignitors, flame scanners, fuel trains, and air quality control systems.

**BENEFITS**

- With 100% hydrogen firing, BrightGen produces no carbon dioxide (CO<sub>2</sub>) emissions.
- BrightGen can also be fired with a blend of hydrogen and other lower-carbon gaseous fuel (such as natural gas or process off-gas) to take advantage of fuel availability and pricing to generate lower CO<sub>2</sub> emissions.
- The BrightGen technology can be provided with new boiler installations or as a retrofit in fuel switching applications.



**KEY DATA**

TRL	9	Capture Rate Range (tpd)	~	Modular (Y/N)	Yes
Source CO <sub>2</sub> Purity Range	~	Energy Consumption (GJ/tCO <sub>2</sub> )	~	Capture Efficiency (%)	~
Number of Commercial Plants	60+	Number of Pilot Plants	~		
Target Industries	Oil & Gas, Refineries, Power Utilities, Iron & Steel, Pulp & Paper, any medium to heavy industrial facility				



marketing@babcock.com

www.babcock.com

**SUMMARY**

B&W's oxy-combustion process can be used to generate steam and power using a variety of fuels, including coal, natural gas, biomass, oil, and others. In the oxy-fuel process, combustion air is replaced with nearly pure oxygen and recirculated CO<sub>2</sub>. Nitrogen that would normally be conveyed with the air through conventional air-fuel firing is excluded and the resulting flue gas consists of nearly pure CO<sub>2</sub>. The non-recirculated flue gas leaving the boiler is cleaned using conventional particulate and sulfur removal systems and sent to the compression purification unit (CPU) where a high-purity CO<sub>2</sub> stream is produced that is suitable for transportation or other uses.

Combining B&W's OxyBright technology with biomass-fired technology, such as our bubbling fluidised-bed (BFB) boiler, along with carbon capture and sequestration, energy is produced with a net-negative carbon intensity. Biomass such as forest litter, construction and demolition waste, or agricultural byproducts, can fuel our BFB boiler. BECCS (bioenergy production with carbon capture and sequestration) is a highly scalable technology and is an emerging innovative solution to decarbonise emission-intensive industries.

**BENEFITS**

- The combustion process produces a concentrated CO<sub>2</sub> stream suitable for sequestration or other beneficial uses; no post-combustion equipment is required.
- Applicable to a variety of fuel sources.
- Can be retrofitted on existing plants or designed for new steam generation installations.
- Net-negative carbon intensity when biomass is the fuel source and is combined with carbon capture and storage (BECCS).

**KEY PROJECTS**

- B&W provided oxy-fuel technology for use with coal on the U.S. Department of Energy's FutureGen 2.0 demonstration project in Illinois, which was to be a retrofit of a 167 MW coal-fired power plant. Although construction began in 2014, the project was canceled in 2016 due to redirection of DOE funding support. B&W has continued to develop oxy-fuel technology and it is ready for full-scale commercialization and deployment.
- In March 2022, B&W announced its OxyBright and its BFB biomass boiler-fired technologies would be part of the world's largest net-negative CO<sub>2</sub> biomass-to-energy facility to be developed by Fidelis New Energy at the Port of Great Baton Rouge, Louisiana.

**KEY DATA**

TRL	8	Capture Rate Range (tpd)	~	Modular (Y/N)	No
Source CO <sub>2</sub> Purity Range	~	Energy Consumption (GJ/tCO <sub>2</sub> )	~	Capture Efficiency (%)	~
Number of Commercial Plants	0	Number of Pilot Plants	2		
Target Industries	Utility Power, Medium to Heavy Industry, Waste/Biomass to Energy				

# SOLVEBRIGHT™ POST-COMBUSTION CARBON CAPTURE

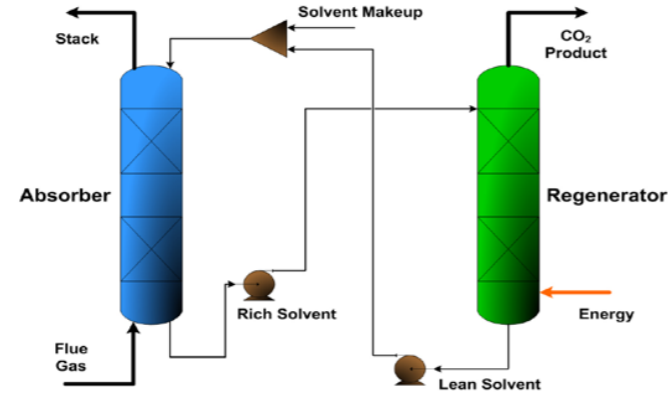

[marketing@babcock.com](mailto:marketing@babcock.com)

[www.babcock.com](http://www.babcock.com)

## SUMMARY

B&W's SolveBright regenerable solvent absorption technology scrubbing process came from decades of decarbonisation research and development.

The SolveBright carbon dioxide scrubbing system is a post-combustion carbon capture technology that captures CO<sub>2</sub> directly from flue gas in an absorber using a regenerable solvent. The CO<sub>2</sub>-rich solvent is sent to a regenerator where it is heated, and the CO<sub>2</sub> is released as a concentrated stream for compression and storage or beneficial uses. The CO<sub>2</sub>-lean solvent is then recycled to the absorber for reuse.

While B&W's solvent compared favorably with more than 100 competing solvents during our extensive testing procedures at the National Carbon Capture Center, a major advantage of the SolveBright process is solvent flexibility, which allows customisation of an optimal CAPEX and OPEX solution for each application. SolveBright can be used with a variety of solvents and we have the expertise and ability to use a wide range of potential solvents.

## BENEFITS

- Solvent flexibility, allowing us to customise an optimal CAPEX and OPEX solution for each application.
- Knowledge of solvent scrubbing solutions for carbon capture since 2005; we understand the process, the equipment and the innovation behind the various type of solvents used.
- Experience across a wide range of industries with various fuels and combustion processes: from utilising waste and biomass as fuels to industries such as cement, steel, chemical, oil and gas, pulp and paper, food and beverage, and many others looking for reliable decarbonisation partners.
- Total solution support, from feasibility studies, pre-FEED and pilot unit definition, FEED studies, to full-scale plants, tailored to the customers' specific needs.

*This page has been intentionally left blank.*

## KEY DATA

TRL	8-9	Capture Rate Range (tpd)	~	Modular (Y/N)	No
Source CO <sub>2</sub> Purity Range	~	Energy Consumption (GJ/tCO <sub>2</sub> )	~	Capture Efficiency (%)	~
Number of Commercial Plants	~	Number of Pilot Plants	~		
Target Industries	Utility Power, Medium to Heavy Industry, Waste/Biomass to Energy				





[marketing@babcock.com](mailto:marketing@babcock.com)

[www.babcock.com](http://www.babcock.com)

## SUMMARY

Acid gases degrade the solvents used in a post-combustion carbon capture system. B&W offers a complete suite of environmental control technologies to control sulphur dioxide (SO<sub>2</sub>), sulphur trioxide (SO<sub>3</sub>) – which can form aerosols and cause loss of CO<sub>2</sub> capture solvents – hydrogen chloride (HCl), and hydrogen fluoride (HF) in the pre-capture flue gas stream, as well as technologies for other pollutants such as metals and particulates. Nitrogen oxides (NO<sub>x</sub>) are also detrimental for CO<sub>2</sub> capture solvents and can lead to hazardous degradation products in the process. CO<sub>2</sub> scrubbing may also improve when particulate matter is removed from the flue gas prior to the scrubbing process.

Pre-treatment of the flue gas is vital for the operation and economics of the process to result in the optimum effectiveness of the carbon capture technology. B&W has many decades of experience in emissions control solutions, pioneering technologies that have helped customers comply with stringent emissions regulations for more than 50 years.

## BENEFITS

- Flue gas pre-treatment provides optimum effectiveness of the post-combustion carbon capture technology.
- Wide range of proven pre-treatment technologies to significantly reduce incoming flue gas pollutants, including sulphur oxides, particulates, nitrogen oxides, mercury and other acid gases.
- Experience with more than 2300 installations of various pollutant control technologies

## KEY PROJECTS

Higher concentrations of a wide range of inlet pollutants lead to higher solvent make-up rates and higher operating costs. Since solvent is typically much more expensive than other reagents, removal of the pollutants upstream of the CO<sub>2</sub> absorber typically results in a reduction of overall operating costs. Our flue gas treatment installations include these impressive numbers which control a wide range of pollutants from diverse industrial segments:

- Wet flue gas desulphurisation (FGD) and wet gas scrubbers: 300+
- Dry scrubber technologies (spray dryer absorbers [SDA] and circulating dry scrubbers [CDS]): 90
- Selective catalytic reduction (SCR): 100+
- Dry sorbent injection (DSI): 35+
- Wet and dry electrostatic precipitators (ESP): 750+
- Fabric filter baghouses: 1000+
- Flue gas condensation: 35+

## KEY DATA

TRL	9	Number of Commercial Plants	2300+	Modular (Y/N)	No
Target Industries	Utility Power, Waste/Biomass to Energy, Medium to Heavy Industry such as Oil & Gas, Refineries, Iron & Steel, Pulp & Paper, Cement				

## TECHNOLOGY DESCRIPTION

### B&W DECARBONISATION TECHNOLOGY OVERVIEW

B&W has a broad range of unique and innovative technologies and processes for carbon capture, hydrogen generation and hydrogen combustion, including:

- CO<sub>2</sub> Removal – Capture (OxyBright, SolveBright, BrightLoop)
- CO<sub>2</sub> Reduction – Efficiency improvements and fuel mixing
- CO<sub>2</sub> Avoidance – Replacing carbon-intensive power generation with renewables (BECCS, green steam, LDES, solar); fuel switching and combustion of hydrogen or ammonia (BrightGen, BrightLoop)
- CO<sub>2</sub> Reuse – Capture carbon for beneficial use (P2X [biogenic CO<sub>2</sub>]); food & beverage use (OxyBright, SolveBright, BrightLoop)

- CO<sub>2</sub> Storage – Capture and store (OxyBright, SolveBright, BrightLoop)
- Low Carbon Intensity Hydrogen Generation – (BrightLoop)
- Hydrogen Combustion – (BrightGen)
- CO<sub>2</sub> Capture Optimisation – Flue gas pre-treatment (full suite of B&W environmental technologies)

More information on B&W's ClimateBright suite of products is available at [www.babcock.com](http://www.babcock.com).





[gianluca.difederico@bakerhughes.com](mailto:gianluca.difederico@bakerhughes.com)

[www.bakerhughes.com](http://www.bakerhughes.com)

## SUMMARY

The Chilled Ammonia Process (CAP) was developed to address the challenges of removing carbon dioxide from low-pressure flue gases, which were generated by fossil-fuel-based power plants and industrial emissions points.

CAP is a post-combustion carbon-capture process that uses a non-proprietary solvent formulation based on ammonia. Ammonia is a low-cost, inorganic commodity chemical, readily available on the global market from multiple sources and not bound to any specific supplier. It is also stable, tolerant to flue gas contaminants and typically exhibits very low and controllable loss in the CAP process. Moreover, green ammonia (produced from green hydrogen) could be used instead of conventional ammonia in the CAP process.

## BENEFITS

- Demonstrated low specific thermal energy consumption of 2.6 GJ/ton CO<sub>2</sub>
- Uses ammonia, a commodity chemical that is easily procured and not bound to a specific supplier
- Stable reagent. Unlike amine-based solvent systems, it does not suffer from thermal and oxidative degradations
- Flexible for process integration. Allows efficient-direct high temperature waste heat utilisation or direct electrical heating without the degradation of solvent performance
- Tolerant towards oxygen in flue gas and towards contaminants such as SO<sub>x</sub> and NO<sub>x</sub>
- Produces less harmful emissions and potentially useful by-products
- Regenerates CO<sub>2</sub> at high purity (> 99.5%) at elevated pressure, thus requiring less compression energy for the downstream CO<sub>2</sub> product

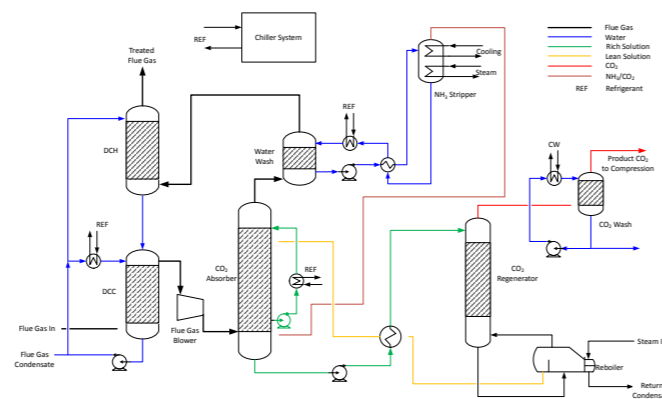

## KEY DATA

TRL	7	Capture Rate Range (tpd)	~	Modular (Y/N)	~
Source CO <sub>2</sub> Purity Range	~	Energy Consumption (GJ/tCO <sub>2</sub> )	2.6	Capture Efficiency (%)	~
Number of Commercial Plants	~	Number of Pilot Plants	~		
Target Industries	Fossil Fuel-Based Power Plants, Waste to Energy & Biomass Power Plants, Cement Plants, Refineries and Petrochemical Complexes				

## TECHNOLOGY DESCRIPTION

The Chilled Ammonia Process (CAP) uses an ammoniated aqueous carbonate solution to absorb CO<sub>2</sub> from the flue gases at ambient pressure and low temperature. Unlike other technologies, the functionality of the ammonium solution is not affected by oxygen and easily purged of heat stable salts formed by trace acidic components, which may pass dedicated flue gas preconditioning steps. Moreover, since its gaseous emissions and liquid waste streams are non-toxic, no additional treatment facilities are required.

A simplified process flow diagram of the CAP technology is shown in the accompanying figure and the process can be described as follows.

Inlet flue gas first undergoes cooling via a direct contact cooler (DCC) that enables the contact of gas with cooling and chilled water to lower the flue gas temperature to a suitable level (typically below 15 °C), which is needed for the CO<sub>2</sub> absorption process and water balance. Most of the water vapour contained in the flue gas is removed in this step, which reduces the volumetric gas flow and increases the CO<sub>2</sub> concentration. For conventional amine-based solvents, a flue gas pre-treatment step is required, which is typically integrated with the DCC to reduce NO<sub>x</sub>, SO<sub>x</sub> and other contaminants in the flue gas to very low levels to decrease degradation and formation of heat-stable salts when the flue gas interacts with the solvent. However, for CAP, this pre-treatment step is typically not required as the ammonia-based solvent is able to tolerate these flue gas contaminants. Strong acids such as SO<sub>x</sub> react with ammonia and form heat-stable salts, which are withdrawn from the system as an aqueous by-product.

Cooled flue gas from the DCC enters the bottom of the absorber column, where it is washed counter-currently with lean ammonia-based solvent (orange line). CO<sub>2</sub> is selectively removed from the flue gas in a chemical absorption process using the alkaline lean solvent. The lean solvent is a solution comprising ammonia, water and CO<sub>2</sub> where different species (ammonium carbamate, ammonium bicarbonate, ammonium carbonate and a limited amount of free ammonia in an aqueous solution) are in equilibrium. The dissolved ammonia species react with CO<sub>2</sub> from the flue gas in the absorber by shifting the species' equilibria towards bicarbonate. The CO<sub>2</sub>-rich solvent (green line) leaves at the bottom of the absorber and is sent to the regenerator section, where it is heated to a temperature high enough for CO<sub>2</sub> to be released from the solvent. A reboiler located at the bottom of the regenerator column provides the heat to the solvent. The heating source is typically steam, although hot oil or heat from a direct-fired or electric heater can also be used due to the absence of thermal degradation.

Heat is imparted to the solvent to shift the equilibria to ammonia-rich species releasing the absorbed CO<sub>2</sub>, which leaves at the top of the regenerator column. Compared to the amine-based post-combustion technologies that regenerate CO<sub>2</sub> at near atmospheric pressure, CAP regenerates CO<sub>2</sub> at an elevated pressure (14 bar - 25 bar(a)), which reduces the downstream compression power requirements.

Regenerated lean solvent (orange line) is returned to the absorber after undergoing cooling through heat exchange with the cold rich solvent in the lean-rich heat exchanger, which simultaneously heats the rich solvent. This is an important heat integration step that significantly reduces the reboiler heat requirement.

Treated flue gas exiting the top of the absorber column contains residual CO<sub>2</sub> and ammonia, which is recovered with a water wash step to prevent unacceptable emissions of ammonia into the atmosphere. After the water wash step, the flue gas is routed to a flue gas heater. A guard system is integrated with the flue gas heater, which relies on the injection of sulfuric acid to neutralise any residual ammonia, converting it into ammonium sulphate. The flue gas is reheated with warm water condensed from the DCC, which serves to raise the temperature of the final treated flue gas to a temperature high enough to be released into the stack and to optimise the water balance of the system.

Amine-based solvents have a tendency to degrade as a result of exposure to hot environments (thermal degradation), in the presence of oxygen (oxidative degradation) and in acid gas reactions (such as NO<sub>x</sub>). The degradation results in a reduction of performance, solvent loss, equipment corrosion and the generation of volatile degradation compounds that are emitted into the treated flue gas, including nitrosamines, which are known carcinogens. Such degradation phenomena are absent for CAP, as the process uses an ammonia-based solvent, which is inorganic. CAP has the added advantage of being able to regenerate CO<sub>2</sub> at elevated pressure, resulting in reduced energy costs to liquefy or further compress the CO<sub>2</sub> downstream.

CAP has been validated at several test facilities with a design capacity of up to 100 ktpa CO<sub>2</sub>, treating flue gases generated by oil boilers, coal boilers and industrial off-gases. A CAP plant designed to capture up to 80 ktpa CO<sub>2</sub> has been operated at Test Centre Mongstad (TCM) in Norway for 2 years, where it demonstrated low specific thermal energy consumption of 2.6 GJ/ton CO<sub>2</sub> on refinery cracker offgas (12.5 -16.0% CO<sub>2</sub>). The testing at TCM also demonstrated CAP's ability for quick start-up, low ammonia emissions, high CO<sub>2</sub> product purity and meeting targeted CO<sub>2</sub> capture rates.



[gianluca.difederico@bakerhughes.com](mailto:gianluca.difederico@bakerhughes.com)

[www.bakerhughes.com](http://www.bakerhughes.com)

### SUMMARY

Compact Carbon Capture (CCC) is a pioneering technology development in the Baker Hughes CCUS portfolio. CCC employs the Rotating Packed Bed (RPB) technology, a novel process intensification that utilises centrifugal acceleration to intensify mass transfer reducing the equipment size and cost. CCC is developed for post-combustion applications and for small to medium sizes of emissions.

By using RPB technology, CCC drastically increases the vapor-liquid contact area, overcoming the traditional hydraulics limitations. Compared to conventional solvent-based systems using static equipment, CCC's enhanced mass transfer results in reduced residence time in the absorber and the regenerator requiring much smaller equipment. CCC also proposes the regenerator and the reboiler integrated into one unique equipment, which results in a further reduction of the plant's footprint.

CCC is currently validated in a pilot of 1.7 ktpa CO<sub>2</sub> at Equinor's test facilities in Porsgrunn, Norway. Further development is ongoing, with a demonstration plant at 5 ktpa scale currently under EPC phase.

### BENEFITS

- Minimum 95% CO<sub>2</sub> capture rate for a flue gas with 10% CO<sub>2</sub> concentration
- Compared to conventional CO<sub>2</sub> capture plants:
  - Up to 50% reduction in CAPEX
  - High equipment size and footprint reduction
  - Reduction of operating expenses by lower solvent inventory
  - Lower electricity consumption for CO<sub>2</sub> transportation (compression), as CO<sub>2</sub> can be regenerated at higher pressure
- Reduced lead time through modularised solution design thinking for simplified logistics, and decreased demand for civil works

### KEY DATA

TRL	5*	Capture Rate Range (tpd)	~	Modular (Y/N)	Yes
Source CO <sub>2</sub> Purity Range	4-25%	Energy Consumption (GJ/tCO <sub>2</sub> )	~	Capture Efficiency (%)	95%
Number of Commercial Plants	~	Number of Pilot Plants	1*		
Target Industries	Fossil Fuel-Based Power Plants, Waste to Energy & Biomass Power Plants, Cement Plants, Refineries and Petrochemical Complexes				

\* A demonstration plant at 5 ktpa scale is currently under EPC phase to meet TRL 7

### TECHNOLOGY DESCRIPTION

Compact Carbon Capture has transformed the process equipment used in post-combustion carbon capture by introducing rotation and high G-forces to capture CO<sub>2</sub>.

#### ABSORPTION SECTION

In the Rotating Desorber, the G-forces are created in several cross-flow rotating packed beds. CO<sub>2</sub>-lean solvent is distributed from the inner axis and horizontally flung outwards in the direction of the wall of the column, while the flue gas moves vertically from the bottom to the top. Mass transfer takes place between the flue gas and the solvent in a cross-flow type arrangement.

Due to the rotation of the packed bed within the column that induces high centrifugal forces, the solvent is accelerated when it hits the packing structure, forming small droplets. This generates a large vapor-liquid contact area compared to conventional static mass transfer which relies on gravity. The larger contact area between gas and liquid results in a faster mass transfer of CO<sub>2</sub> from the flue gas into the solvent droplets, resulting in a much shorter absorber column height compared to conventional columns.

The short contact time allows for the operation with highly viscous solvents that improve the process efficiency. Higher concentrated solvents result in higher absorption rates. When this is combined with the compactness introduced by the process intensification, a considerably lower solvent inventory is needed, resulting in smaller capacity and size of pumps and other equipment in charge of solvent handling.

#### REGENERATION SECTION

The rotating desorber is a compact equipment combining the reboiler and stripper, that can operate at higher pressures and can handle highly viscous solvents. High-speed rotation of the desorber unit introduces turbulence and high G-forces to the solvent regeneration, which are advantageous for mass and heat transfer, resulting in a very compact equipment. The rotating desorber can be described as a lightweight pressurised shell-and-tube heat exchanger where the "hot-side" tube bundle rotates to generate the centrifugal force required to produce small solvent droplets. Instead of a static regenerator column with attached reboiler in a conventional solvent-based system, CCC will have a single compact rotating bed/flash drum that heats the rich solvent and flashes off CO<sub>2</sub> to generate a high purity (>99%) CO<sub>2</sub> product stream.

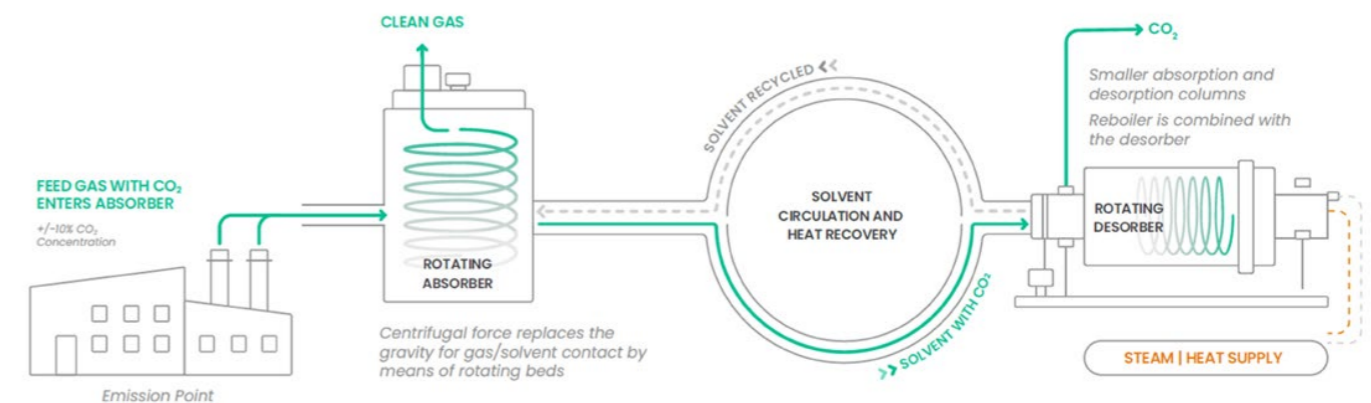



 gianluca.difederico@bakerhughes.com

 www.bakerhughes.com

**SUMMARY**

Baker Hughes uses the Mixed-Salt Process (MSP) for CO<sub>2</sub> capture under license from SRI International. SRI International received support from the US Department of Energy’s Office of Fossil Energy and National Energy Technology Laboratory (NETL) for the development of this technology.

MSP is a post-combustion carbon-capture process that uses a novel solvent formulation, which is based on potassium carbonate and ammonium salts. Both chemicals are low-cost, inorganic commodity chemicals, and readily available on the global market from multiple sources. The inorganic solvent used by MSP is tolerant to flue gas contaminants (such as SO<sub>x</sub>, NO<sub>x</sub>, and O<sub>2</sub>), unaffected by thermal and oxidative degradation, results in lower emissions, lower toxicity, and higher CO<sub>2</sub> regeneration pressure compared to conventional amine-based solutions. MSP has been demonstrated at the capacity of 0.25 tpd at the SRI campus in Menlo Park, US. A 10 tpd pilot-scale plant to demonstrate the MSP technology at the National Carbon Capture Center in Alabama is currently in the construction phase.

**BENEFITS**

- Reduced reboiler energy consumption of 2.0 – 2.3 GJ/ton CO<sub>2</sub>
- Uses inexpensive, industrially available chemicals (potassium and ammonium salts)
- Stable reagent. Unlike amine-based solvent systems, it does not suffer from thermal and oxidative degradation
- Tolerant towards oxygen in flue gas and to contaminants such as SO<sub>x</sub> and NO<sub>x</sub>
- Regenerates CO<sub>2</sub> at elevated pressure, thus requiring less compression energy for the downstream CO<sub>2</sub> product
- Reduced auxiliary electricity loads

**KEY DATA**

TRL	5*	Capture Rate Range (tpd)	~	Modular (Y/N)	~
Source CO <sub>2</sub> Purity Range	~	Energy Consumption (GJ/tCO <sub>2</sub> )	2.0-2.3	Capture Efficiency (%)	~
Number of Commercial Plants	~	Number of Pilot Plants	2**		
Target Industries	~				

\* Pilot plant (4 ktpa) under construction by SRI.

\*\* Pilot plant and mobile pilot undergoing design by Baker Hughes.

**TECHNOLOGY DESCRIPTION**

MSP is a post-combustion technology that is applicable to a wide range of flue gases. It uses a blend of ammonium and potassium-based salts to absorb CO<sub>2</sub> from flue gases at ambient pressure and temperature. The stability of the inorganic solvent used by MSP’s ammonium solution is not affected by oxygen and shows high tolerance to acidic trace components present in the incoming flue gas. The process is characterised by very low emissions and produces little-to-no toxic waste.

A simplified process flow diagram of the MSP technology is depicted in the accompanying figure and the process can be described as seen below.

Inlet flue gas first undergoes cooling to 20 - 30 °C in a direct contact cooler (DCC) and subsequently enters Absorber 1, where it contacts the mixed salt solvent counter-currently. The mixed salt solvent in Absorber 1, which has a higher concentration of ammonium-based species than potassium-based species (high ammonia/potassium ratio), performs the bulk removal of CO<sub>2</sub>, absorbing 60-80% of the CO<sub>2</sub> in the flue gas. The remaining CO<sub>2</sub> is absorbed in Absorber 2, which operates with the mixed-salt solvent with a lower ratio of ammonium-based species to potassium-based species than that of the solvent feed of Absorber 1. Absorber 2 performs the trim removal of CO<sub>2</sub> to achieve an overall CO<sub>2</sub> capture rate of more than 90% and reduces the ammonia slip from Absorber 1. A water wash located at the

top of Absorber 2 further reduces the ammonia content in the treated flue gas to ensure that it meets the ammonia emission limits.

Both absorbers operate with liquid recycle using heat exchangers to remove the heat of reaction and keep the solution at the optimum temperature for efficient absorption and minimum ammonia slip. The CO<sub>2</sub>-rich solvent collected from the absorbers is sent to the regenerator for regeneration via an integrated rich-lean heat exchanger network that is designed to recover sensible heat.

Heat is supplied to the regenerator via a reboiler located at the bottom of the column. The increase in temperature releases CO<sub>2</sub> as a gas and regenerates the mixed-salt solvent to be returned to Absorber 1 and Absorber 2. CO<sub>2</sub> is released at an elevated pressure of 10 - 20 bar(a) from the regenerator column, which serves to reduce the downstream CO<sub>2</sub> compression power requirements.

The CO<sub>2</sub>-lean mixed salt solvent is drawn from the lower-middle stage of the column and sent back to Absorber 1 to perform bulk CO<sub>2</sub> removal. Near the bottom of the regenerator where the temperature is higher, ammonia is vaporised, resulting in a lean solvent with low ammonia/potassium ratio, which is returned to Absorber 2 where it performs the trim removal of CO<sub>2</sub> and reduces ammonia losses.

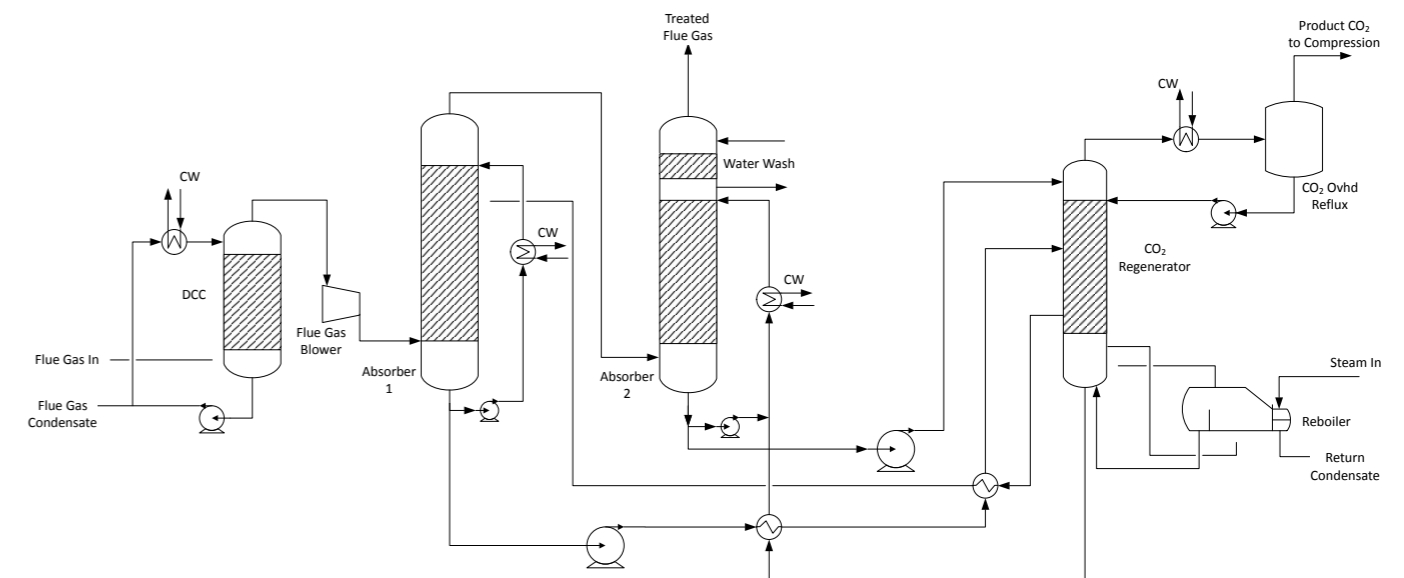

A simplified process flow diagram of the MSP technology.



[gianluca.difederico@bakerhughes.com](mailto:gianluca.difederico@bakerhughes.com)

[www.bakerhughes.com](http://www.bakerhughes.com)

## SUMMARY

Baker Hughes has acquired a Canadian start-up, Industrial Climate Solutions (ICS), to further strengthen engineering technology developments through process intensification. The technology provided by ICS is the Regenerative Froth Contactor (RFC) equipped with Corrugated Screen Packing (CSP). The RFC operates in co-current flow under the pulse regime generated by the gas and liquid phases that flow through the CSP packing, a static equipment. The RFC provides an increase of effective mass transfer surface that reduces the required packing volume, within admissible pressure drop values for the process. ICS is currently conducting the implementation for post-combustion carbon capture applications within Baker Hughes portfolio.

## BENEFITS

- Higher mass transfer rate
- Significant absorption tower height reduction
- Significant absorption tower cross-sectional area and footprint reduction
- Fouling and salts deposition resistance
- Limited impact of high viscosity on mass transfer rate

## KEY DATA

TRL	5
-----	---

## TECHNOLOGY DESCRIPTION

The Regenerative Froth Contactor (RFC) provided by ICS is an innovative gas/liquid absorption co-current contactor system equipped with the Corrugated Screen Packing (CSP) that offers promising reductions in equipment size versus conventional absorbers. The RFC absorber represents a cutting-edge technology. It is static equipment, having no moving parts, and operates in a downward gas- liquid 'co-flow' configuration, with pulse regime hydrodynamic condition. While conventional absorbers work with a thin film of liquid over the packing itself, the CSP is made of convoluted screens that maximise the solvent pulsing effect while minimising the metal packing material; by inducing the RFC to operate under a froth condition in two phase flow, the diffusivity film over the traditional packing surface is replaced by millions of bubbles and droplets in the volume of the tower. These bubbles are created as bands of froth collapse and are regenerated. The liquid and gas phases enter the tower co-currently from the top, flow through the absorber in pulsing regime and are disengaged at the bottom of the tower. The pulse flow is not imposed by a mechanical stimulation but set up as a purely hydrodynamic multi-phase phenomenon depending on the phases flow rates and the CSP design. The gas passes through multiple zones of froth along the

absorber and gas components gets absorbed into the solvent.

In carbon capture application, the CO<sub>2</sub> will be transferred from the gas into the liquid phase in the froth present throughout the whole volume of the column. The RFC absorber/reactor design enables the system to accommodate high gas flow rates and liquid/gas ratios at acceptable back pressure and without encountering flooding in the column. RFC systems can also be used in processes with precipitating solvents or high levels of entrained solids, leading to 3-phase contactors. There is minimal-to-no fouling or additional pressure drop penalty with RFC technology, even under high particulate loads and high viscosity.

Based on the selected gas/liquid system's physical properties (e.g. viscosity, presence of solid precipitation), the geometry of the CSP packing can be selected to enforce a coarser/thinner froth.

Applications of the RFC technology can be used across various carbon capture platforms, ranging from natural gas treatment, post-combustion capture, and air pollution control, e.g., indoor air quality management, direct air capture

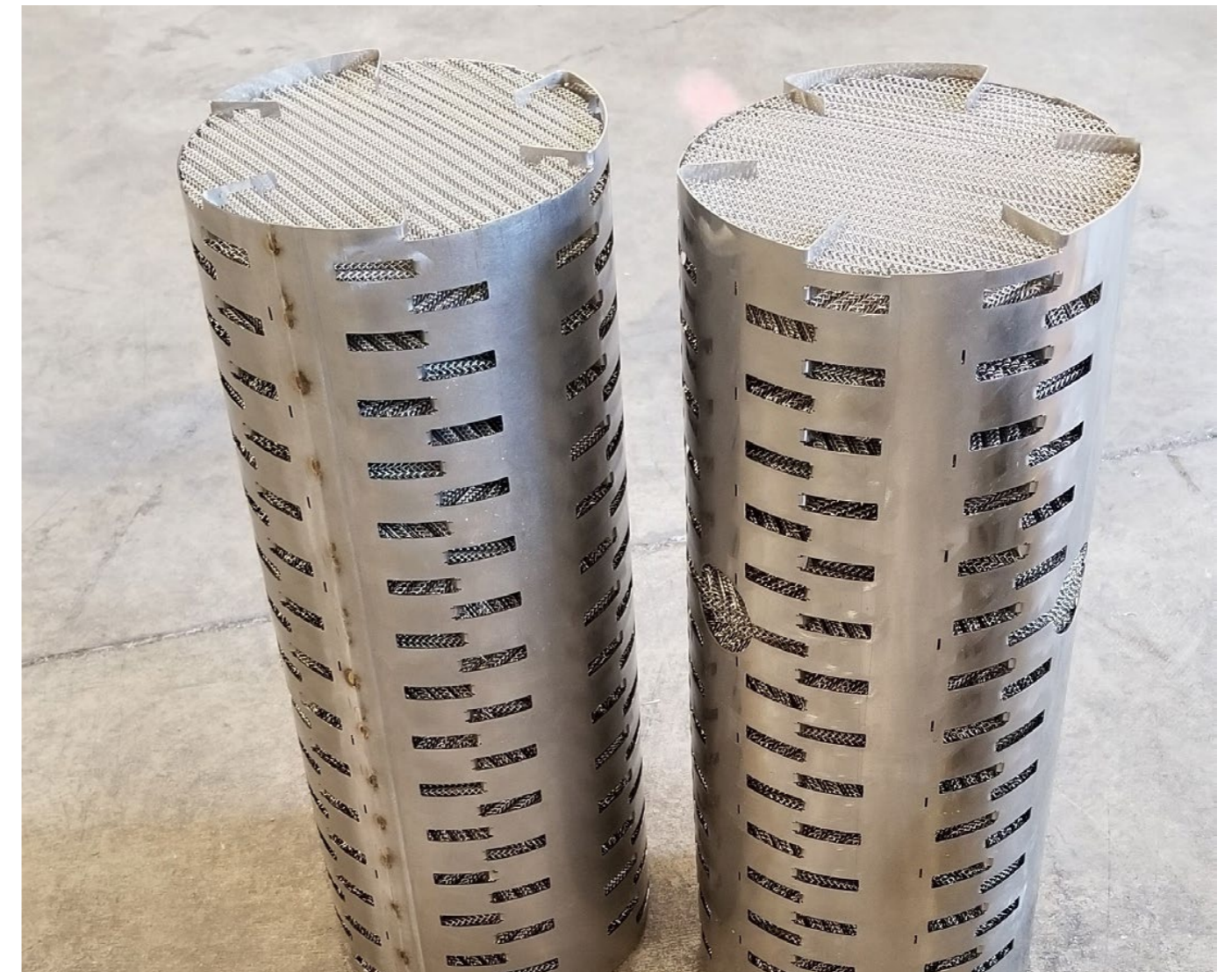



[www.oase-gastreatment.com](http://www.oase-gastreatment.com)

**SUMMARY**

BASF, the world's largest chemical company, markets sustainable and innovative solutions. BASF introduced the first specialty-amine-based CO<sub>2</sub> capture technology in the 1970s, which later developed into BASF's OASE® technology. With 500+ references, the licensed OASE® technologies are now the technologies of choice for amine-based acid gas removal units (AGRU) in the treatment of natural gas, HyCO/NH<sub>3</sub>, selective sulphur removal, biogas, and flue gas. Solutions for the flue gas segment are marketed under the OASE® blue brand.

Each OASE® facility's design and solvent are customised to the specific project requirements. Customers benefit from a cradle-to-grave optimisation of the performance and the security of BASF's own solvent supply backed up by all of BASF's chemistry know-how. OASE® offers customers access to OASE® connect – BASF's proprietary digital customer interaction platform which comprises BASF's proprietary in-house simulation tool, an analytical database, and BASF's online solvent analyzer OASE® digilab. OASE® is marketed non-exclusively and holds regular customer workshops.

**BENEFITS**

**OASE® provides business partners with:**

- Know-how derived from over 500 references and BASF's expertise in chemistry
- Non-exclusive access to OASE® technology for customers and engineering companies
- OASE® solvents produced and supplied by BASF
- Exclusive digital tools: OASE® connect & OASE® digilab
- Customised design, operating and analytical manuals

- Wide operating range applicable to most flue gas sources
- Long track record and expertise in large-scale CO<sub>2</sub> capture units' design and operation
- Unique licensing model integrating license and solvent sales

**Benefits of the OASE® blue solvent:**

- Low regeneration energy
- Accelerated kinetics & mass transfer
- High cyclic capacity
- High oxidative resistance / Low degradation / Low make-up rate
- 10-year continuous testing and 7-year commercial operation in various industries
- In-house solvent production

**Benefits of the OASE® blue technology:**

- High energy efficiency and reliability
- Up to 99+% CO<sub>2</sub> capture rate
- High-purity product CO<sub>2</sub> stream suitable for utilisation and sequestration
- OASE® aerozone emission reduction technology
- Waste-heat integration

**KEY DATA**

TRL	9	Capture Rate Range (tpd)	10 – 10,000	Modular (Y/N)	Yes
Source CO <sub>2</sub> Purity Range	<0.1 - 70%	Energy Consumption (GJ/tCO <sub>2</sub> )	0.6 – 3.0	Capture Efficiency (%)	>99%
Number of Commercial Plants	>500	Number of Pilot Plants	6	Feed Gas O <sub>2</sub>	Up to 16%
Target Industries	Cement/Lime, Waste-to-Energy, Power, OCCS, LNG, Syngas, Blue H <sub>2</sub> , Oil Refining				

**TECHNOLOGY DESCRIPTION**

**CARBON CAPTURE WITH OASE®**

For over 50 years, BASF has marketed and continuously improved its amine-based acid gas removal technology to provide customised solutions to clients. BASF boasts a comprehensive portfolio of OASE® technologies for applications in which acid gases – primarily CO<sub>2</sub> but also other carbon and sulphur containing compounds – are extracted from gas streams.

OASE® is the leading carbon-capture technology installed in references with a combined capacity of over 100 million Nm<sup>3</sup>/h. Today, 7.6 million tons per year of CO<sub>2</sub> extracted with OASE® are sequestered, while tens of millions of tons per year of CO<sub>2</sub> separated with OASE® are used in downstream applications.

The main applications of the OASE® portfolio include:

OASE purple	Natural Gas, LNG
OASE white	Ammonia, Syngas
OASE yellow	Selective Treatment
OASE green	Biogas
OASE blue	Flue Gas

Each OASE® technology is customised for the specific application and adjusted for the specifics of each project. Factors such as feed-gas composition, treated-gas specifications, purity of acid gas, energy consumption, optimisation of capital expenditures, and other customer requirements characterise the optimised project-specific design provided by the OASE® team.

With their presence in five continents, OASE® technical marketing representatives cover the global demand. These are supported by teams of technical and commercial specialists which ensure modern and proven tools for streamlined execution and highest quality.

**FLUE GAS TREATMENT WITH OASE® blue**

OASE® blue is a patented technology and proprietary amine solvent blend, customised for greenfield and retrofit flue gas capture applications. BASF uses its own customised in-house simulation tools based on BASF's exhaustive know-how in chemical properties, processing, modelling, and operations. OASE® blue benefits from the experience of designing, operating, and scaling up all applications in the OASE® portfolio of technologies. OASE® blue boasts over 100,000 hours of operation and optimisation and is an integral part of BASF's Net Zero strategy.

OASE® blue proprietary solvent was developed in an R&D phase. Screening of over 200 blends of industrially available amines coupled with BASF's chemistry know-how resulted in the industry's best technology/solvent combination delivering low energy consumption, high oxidative resistance, excellent kinetics & mass-transfer, high cyclic capacity and low make-up rates. The unique OASE® blue solvent composition together with high performance & reliable technology solutions based on BASF's 100+ years

of carbon capture experience & expertise allow to ensure an optimal CAPEX/OPEX balance for the customers' particular flue gas and product gas specifications.

Implementing heat-integration concepts for facilities with available energy is an integral part of the OASE® blue design.

A patented emission control system, OASE® aerozone is integrated into the OASE® blue process to manage aerosols and minimise emissions in the treated gas. Furthermore, a unique degradation-component management system ensures minimisation of these components and minimises emissions.

The OASE® deliverables include a process design package, license, warranties, solvent and services. OASE® is offered in non-exclusive agreements to engineering companies and end users.

As a producer of the OASE® solvent, BASF is the only technology provider that can also ensure solvent supply in the rapidly growing carbon-capture market.

The OASE® licensing model is offered in various versions. In addition to the classical "up-front" model, where a lump sum for the license is paid during the project execution, OASE® can also be licensed with a model which aligns payments with actual CO<sub>2</sub> production and supply of refill solvent. This allows for cash flow for license and refill solvent to be aligned with revenues which are realised only during operation.

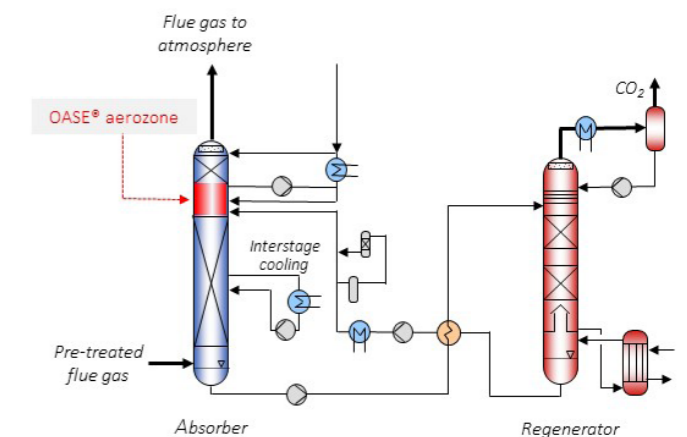

The Post Combustion Carbon Capture Process based on OASE® blue Technology

**OASE® white, OASE® purple & OASE® yellow**

Utilised in the removal of acid gases, these state-of-the-art OASE® technologies have proven their versatility and reliability in synthesis-gas and natural-gas applications – from treating hydrogen (H<sub>2</sub>) and/or carbon monoxide (CO) streams, over bulk removal of acid gasses in LNG applications, to selective removal of sulfur components for sales gas, acid-gas enrichment (AGE) and tail-gas treatment (TGT) units. Backed by hundreds of references including BASF's own facilities, these highly efficient and environmentally friendly technologies offer both flexible operability and reduced capital expenditure (CAPEX), while the low energy demand of the processes and their non-corrosive solvent minimise operating and maintenance costs (OPEX). They also provide a high level of gas purity and product gas recovery while keeping solvent losses to a minimum.



[tone.bekkestad@capsoltechnologies.com](mailto:tone.bekkestad@capsoltechnologies.com)

[www.capsoltechnologies.com](http://www.capsoltechnologies.com)

### SUMMARY

Capsol Technologies is a carbon capture technology provider with a goal of accelerating the transition to a net zero future. Capsol's post-combustion carbon capture and heat recovery system in one delivers superior efficiency with a proven and safe solvent. Key segments include cement, biomass, energy-from-waste and gas turbines.

Capsol's technologies are applicable to all hard-to-abate industries and deliver superior performance throughout the entire carbon capture process, ensuring safe operations and industry-leading capture costs. The solutions utilise the non-toxic and non-degradable solvent HPC with superior HSE profile, making permitting easier. The technology is licensed either directly to customers or through industrial partners globally.

Capsol's technologies are based on 15+ years of R&D, with active patents across 11 patent families, and more than 11,000 hours in operation with a chemistry that is industry-proven in hundreds of plants and commercially ready for licensing globally.

### BENEFITS

- Capsol offers a carbon capture technology platform with patented energy reuse to hard-to-abate industries such as cement, biomass, energy-from-waste and gas turbines.
- Capsol's solutions are fully electric. The capture unit requires no external steam production or investment in additional steam generation
- The technologies' inherent heat recovery produces heat at usable temperatures, which improves energy efficiency and reduces opex
- Designed as standalone units, Capsol's carbon capture solution can be installed with minimal impact on uptime and project risk
- Its non-proprietary solvent is non-toxic and non-degradable with superior HSE profile, making permitting easier

### KEY PROJECTS

In July 2022, Capsol signed a license agreement for CapsolEoP® at the biomass-powered CHP plant Värtaverket in Stockholm, Sweden. Once operational, Värtaverket will be Europe's first large-scale negative emissions plant, with the removal of 800,000 tons of CO<sub>2</sub> per year, potentially making Stockholm the first carbon neutral capital of the world. The project is awarded EUR 180 million by the EU. On 6 May 2024, Stockholm Exergi announced the world's largest to date permanent off-take agreement with Microsoft on the sale of 3.33 million tons of permanent carbon removals.

On 27 December 2023, Capsol Technologies signed a Frame License Agreement for the use of CapsolEoP® in full-scale carbon capture projects with a European utility owning many EfW and biomass plants in Europe. The first projects expected to be executed under the agreement will have a combined planned capacity of around 550,000 tons of CO<sub>2</sub> per year.

### KEY DATA

TRL	7 - 8	Capture Rate Range (tpd)	100 - 5,500	Modular (Y/N)	No
Source CO <sub>2</sub> Purity Range	>99.9%	Energy Consumption (GJ/tCO <sub>2</sub> )	0.7 - 1.5 GJ/t electric	Capture Efficiency (%)	90 - 95%
Number of Commercial Plants	0	Number of Pilot Plants	3	Applicable for other hard-to-abate industries	
Target Industries	Cement, biomass, Energy-from-Waste/Waste-to-Energy, lime				

### TECHNOLOGY DESCRIPTION

Capsol Technologies has a carbon capture technology platform with patented energy reuse. The technology is based on 15+ years of R&D, can run fully electric, no external steam needed, and little to no water need. Capsol's energy-efficient and cost-competitive solutions are licensed out, either directly to customers or through industrial partners globally. It is a carbon capture and heat recovery system in one, offering superior HSE performance. Key segments include cement, biomass, energy-from-waste and gas turbines.

Capsol offers a portfolio of technologies built on a continuously growing base of patents for energy-efficient post-combustion carbon capture. Capsol currently has active patents across 11 patent families. The first successful test of the technology was performed in 2008 at the Värtan combined heat and power (CHP) plant in Stockholm, Sweden. The company currently operates three carbon capture and two liquefaction demonstration units on several flue gas streams in Europe. In total, our units and previous tests have more than 11,000 hours of operation verifying the effectiveness of the CapsolEoP® solution. CapsolGo® is a powerful tool to demonstrate safe carbon capture to various stakeholders, including the opportunity to verify Capsol's EoP® (end-of-pipe) technology effectiveness on the emitters' facilities, to accelerate the process and investment decision for a full-scale carbon capture plant. You can read more about the CapsolGo® demonstration unit and the benefits it provides for the emitter, in the separate description of CapsolGo® on the following pages.

Capsol's technology platform with heat recuperation is applicable to all hard-to-abate industries with flue gas CO<sub>2</sub> concentration levels from 3-30% and delivers superior performance throughout the entire carbon capture process, ensuring safe operations and industry-leading capture costs. The CO<sub>2</sub> purity of the dried gas is more than 99%, meeting storage and utilisation requirements.

The use of HPC for post-combustion (from flue gases) carbon-capture was, until recently, discarded as a viable option due to the high energy demand (and cost) required to pressurise the flue gas before it enters the absorber. To solve this, Capsol developed the CapsolEoP® (end-of-pipe) solution – a standalone, retrofit unit, with inherent heat

recovery, which offers low capture cost and the flexibility to monetise heat and electricity in the capture process.

The capture unit can run on electricity only and there is no need to build an additional boiler for steam production. The electrical energy consumption is between 0.7 and 1.5 GJ/tons of CO<sub>2</sub> captured, depending on the composition and temperature of the flue gas.

Capsol's capture process utilise a non-toxic and non-degradable solvent with superior HSE profile making permitting easier. The chemical process is well-known and used in hundreds of plants for pre-combustion, primarily in the chemical process industry.

As energy typically accounts for 60-75% of the operational costs of a carbon capture plant, and Capsol's solution uses 40-50% less energy than other technologies, Capsol's low energy demand reduces the capture cost by 20-30% per ton CO<sub>2</sub>. If the plant is connected to a district heating network, the thermal power export from the heat recuperation to the district heating network further increases the efficiency of the process.

### SAFE SOLVENT

An increasing number of industrial facilities are aware of the advantages of using the safe and proven potassium carbonate (HPC) solvent - which is well-documented and used in thousands of plants globally in multiple industries, like lower capture and material costs, the solvent being widely available and no risk of harmful emissions. In addition, the solvent's superior HSE performance eases permitting and limits supply chain risks.

### STANDALONE CAPTURE UNIT

Capsol's pressurised absorber design uses less plot space than competing technologies, and the standalone solution allows for easy retrofit and requires no modifications or downtime at parent plant during installation, commissioning or maintenance.

By using well-known components which already are in use in thousands of plants globally, plant lead times can be between 18 and 24 months.

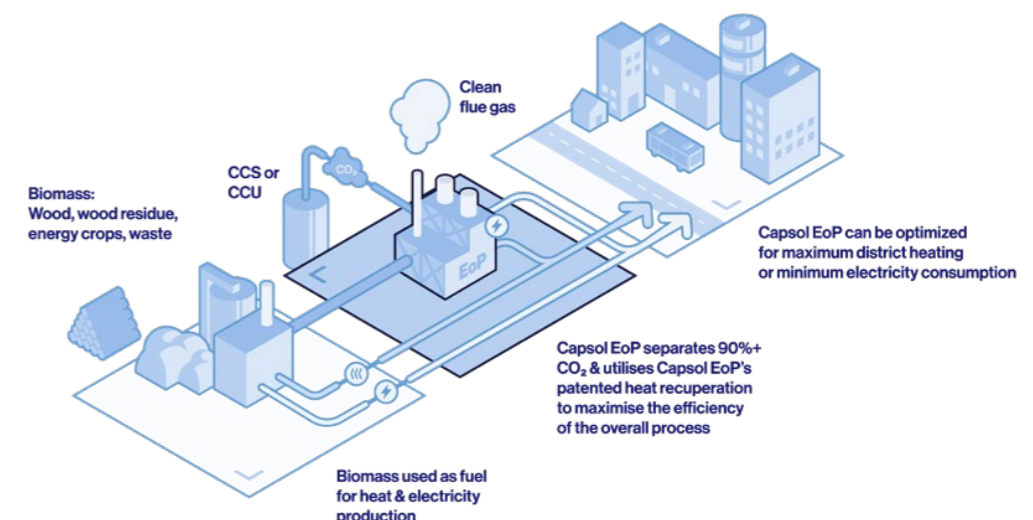



✉ [tone.bekkestad@capsoltechnologies.com](mailto:tone.bekkestad@capsoltechnologies.com)

🌐 [www.capsoltechnologies.com](http://www.capsoltechnologies.com)

**SUMMARY**

Capsol Technologies is a carbon capture technology provider with a goal of accelerating the transition to a net zero future. The company offers a post-combustion carbon capture and heat recovery system in one for superior efficiency with a proven and safe solvent, which is licensed either directly to customers or through industrial partners globally.

Capsol offers a portfolio of technologies based on 15+ years of R&D, active patents across eleven patent families, and more than 11,000 hours in post-combustion flue gas operation with a chemistry that is industry-proven in hundreds of plants.

Capsol's technologies are applicable to all hard-to-abate industries and deliver superior performance throughout the entire CO<sub>2</sub> capture process, ensuring safe operations and industry-leading capture costs. Capsol's capture solutions utilise a non-toxic and non-degradable solvent, with superior HSE profile making operation and permitting easier. Key segments include cement, biomass, energy-from-waste and gas turbines.

**BENEFITS**

- Carbon capture technology platform with patented energy reuse
- Fully electric - no external steam or investment in separate steam generation required
- Inherent heat recovery enables production of additional heat at usable temperatures for improved energy efficiency, reducing opex
- Standalone capture unit which can be installed with minimal main plant interference, optimising project risk
- Non-toxic and non-degradable solvent - superior HSE profile making permitting easier
- Validated technology - based on 15+ years of R&D, reaching eleven patent families
- Commercially ready for licensing globally

**KEY PROJECTS**

Capsol offers CapsolGo® carbon capture and liquefaction units for demonstration purposes to emitters from a variety of industries, for example cement, biomass and energy-from-waste.

A number of demonstration campaigns are finalised with successful results, proving the suitability of HPC capture for the various requirements of the industries' flue gases.

Capsol currently operates demonstration campaigns at plants in Germany and Sweden, enabling the clients to get a deeper understanding of the technology and to verify the capture performance on their specific flue gases.

**EEW Energy from Waste:** CapsolGo® unit one will continue its successful operation until the end of Q2/24

**German Utility:** CapsolGo® unit two and liquefaction unit one will continue operation until the end of Q3/24

**SHI FW & Swedish clients:** CapsolGo® unit three and liquefaction unit two started operations at a Swedish biomass plant at the end of Q2/24

**KEY DATA**

TRL	7 - 8	Capture Rate Range (tpd)	100 - 5,500	Modular (Y/N)	No
Source CO <sub>2</sub> Purity Range	>99.9%	Energy Consumption (GJ/tCO <sub>2</sub> )	0.6 - 1.5 GJ/t electric	Capture Efficiency (%)	90 - 95%
Number of Commercial Plants	0	Number of Pilot Plants	3	Applicable for other hard-to-abate industries	
Target Industries	Cement, biomass, Energy-from-Waste/Waste-to-Energy, lime				

**TECHNOLOGY DESCRIPTION**

CapsolGo® is a mobile, small-scale carbon capture demonstration unit for cement, biomass, energy-from-waste (EfW), power generation and large industrial facilities, designed to answer many of the questions industrial emitters, who consider investing in a full-scale carbon capture plant, may have.

CapsolGo® is an all-inclusive package: transport, installation, de-installation, operation, and reporting by an independent party, is all part of the delivery. The CapsolGo® unit consists of two, easily deployable shipping containers, stacked on top of each other to minimise footprint, which are easy to install. The only infrastructure required by the plant owner is electricity, compressed air, demineralised water, and of course, the flue gas. The plant owner has the option to choose whether the captured CO<sub>2</sub> should be fed back to the flue gas stack or liquefied to demonstrate utilisation options.

Capsol's patented carbon capture solutions, CapsolEoP®, has been developed and improved over the last 15+ years. The first successful test of the technology was performed in 2008 at the Värtan combined heat and power (CHP) plant in Stockholm, Sweden.

CapsolGo® is a powerful tool to demonstrate safe carbon capture to various stakeholders, including the opportunity to verify Capsol's EoP (end-of-pipe) technology effectiveness on the emitters' facilities, to accelerate the process and investment decision for a full-scale CO<sub>2</sub> capture plant.

The CapsolEoP® carbon capture solution can capture CO<sub>2</sub> from a wide range of industries with flue gas CO<sub>2</sub> concentration levels from 3-30%. The CO<sub>2</sub> purity of the dried gas is more than 99%, meeting storage and utilisation requirements.

As energy typically accounts for 60-75% of the operational costs of a carbon capture plant, and Capsol's solution uses 40-50% less energy than other technologies, Capsol's low energy demand reduces the capture cost by 20-30% per tonne CO<sub>2</sub>. If the plant is connected to a district heating network, the thermal power export from the heat recuperation to the district heating network further increases the efficiency of the process.

The company currently operates three carbon capture and two liquefaction demonstration units on several flue gas streams in Europe. In total, our units and previous tests have more than 11 000+ hours of operation verifying the effectiveness of the CapsolEoP® solution.

**SAFE SOLVENT**

An increasing number of industrial facilities are aware of the advantages of using the safe and proven potassium carbonate (HPC) solvent - which is well-documented and used in thousands of plants globally in multiple industries, like lower capture and material costs, the solvent being widely available and no risk of harmful emissions.

**HIGHLIGHTS**

- All-inclusive mobile, small-scale carbon capture demonstration units for cement, biomass, energy-from-waste (EfW), power generation and large industrial facilities.
- Capture capacity of up to 700 tonnes CO<sub>2</sub>/year.
- Test your plant's specific flue gas and operation to define an optimal solvent blend for the full-scale carbon capture plant.
- With a capture capacity of several hundred tonnes of CO<sub>2</sub> per year, CapsolGo® is an affordable solution to get maximum insights into safe carbon capture technology.
- Capsol's carbon capture solution with integrated heat recovery results in significantly lower energy consumption than comparable technologies, which offers low capture cost, the flexibility to monetise heat and electricity in the capture process and a superior HSE which eases permitting.
- The capture unit can run on electricity only and there is no need to build an additional boiler for steam production.

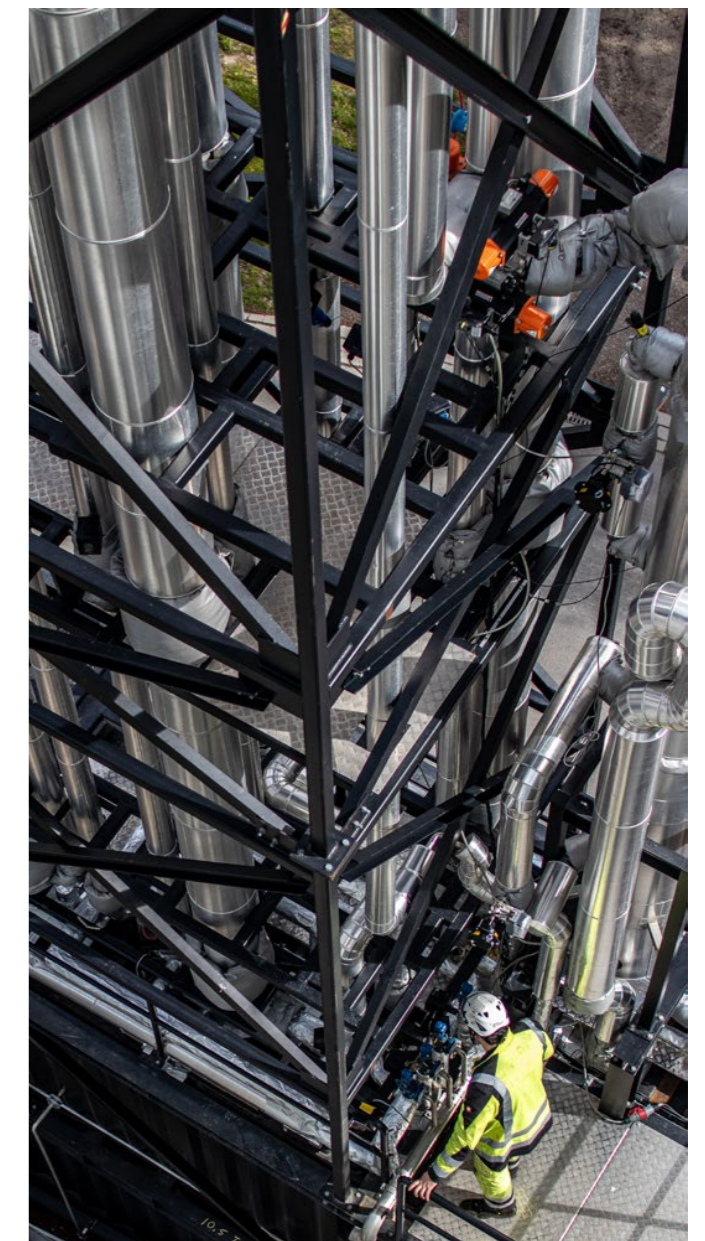



# CAPSOLGT® - ADVANCED CARBON CAPTURE FOR OPEN CYCLE GAS TURBINES



[tone.bekkestad@capsoltechnologies.com](mailto:tone.bekkestad@capsoltechnologies.com)

[www.capsoltechnologies.com](http://www.capsoltechnologies.com)

## SUMMARY

Capsol Technologies has a carbon capture technology platform with patented energy reuse. The technology is based on 15+ years of R&D, can run fully electric without external steam supply, minimising water consumption and the plant's cooling demand. Capsol's energy-efficient and cost-competitive solutions are licensed out, either directly to customers or through industrial partners globally. It is a carbon capture and heat recovery system in one, offering superior HSE performance. Key segments include cement, biomass, energy-from-waste and gas turbines.

During 2023, Capsol experienced accelerated commercial traction in all key segments, emerged as a competitive solution for cement, and initiated fast-tracking of a first-of-a-kind gas turbine solution which is commercialised together with the world's leading gas turbine suppliers, for example GE Vernova.

Capsol offers a portfolio of technologies built on a continuously growing base of patents for energy-efficient post-combustion CO<sub>2</sub> capture. Capsol currently has active patents across 11 patent families. Capsol's technology platform with heat recuperation is applicable to all hard-to-abate industries and delivers superior performance throughout the entire CO<sub>2</sub> capture process, ensuring safe operations and industry-leading capture costs.

Capsol's capture process utilise a non-toxic and non-degradable solvent, with superior HSE profile making permitting easier. The chemical process is well-known and used in hundreds of plants for pre-combustion, primarily in the chemical process industry.

## BENEFITS

- Advanced, stand-alone carbon capture solution for open cycle gas turbines 4-100+ MWe
- Capture rate of 12 000 – 400 000+ tonnes CO<sub>2</sub>/year
- Captures 95%+ of the exhaust gas CO<sub>2</sub> utilising the safe HPC solvent
- Designed for gas power plants (used for electricity production and industrial purposes), gas engines, diesel generators and other industrial facilities
- CapsolGT® is a replacement for a classical steam cycle which reduces complexity, costs and weight
- The unit operates efficiently on electricity alone, generating necessary heat within the system



## KEY DATA

TRL	≥6	Capture Rate Range (tpd)	200 - 1,000 tpd at 95%+	Modular (Y/N)	Yes
Source CO <sub>2</sub> Purity Range	2 - 4vol%	Energy Consumption (GJ/tCO <sub>2</sub> )	For open cycle gas turbines: 0.0 GJ/t electric	Capture Efficiency (%)	90 - 95%
Number of Commercial Plants	0	Number of Pilot Plants	0	Solution processes high temperature exhaust to generate additional electricity	
Target Industries	Gas turbines				

## TECHNOLOGY DESCRIPTION

CapsolGT® is a carbon capture technology tailored exclusively for open cycle gas turbines, empowering sustainable energy solutions.

Building on the CapsolEoP® technology, Capsol is commercialising CapsolGT® together with the world's leading gas turbine suppliers, for example GE Vernova, fast-tracking the deployment of CapsolGT®. A Pre-FEED study for several gas turbine sizes was completed in Q2 2024, demonstrating its potential to make low-carbon gas power generation affordable. The design basis accounted for the challenging conditions of the US Gulf Coast and the Middle East, handling hot ambient temperatures with minimised plant cooling and neutral water balance.

This innovative solution seamlessly integrates with open cycle gas turbines and excels in capturing CO<sub>2</sub> from low-concentration exhaust gases. It operates efficiently on electricity alone, generating the necessary heat for the capture process internally, eliminating reliance on external steam supply, while generating surplus electricity.

CapsolGT® is a highly energy-efficient carbon capture solution for open cycle gas turbines, optimised for 4-100 MWe gas turbines. It is a stand-alone unit that does not require any turbine modifications. The solution can be applied to a variety of industrial applications, such as gas engines, diesel generators and other industrial facilities where high temperature exhaust streams can be utilised.

Harnessing the inherent advantages of gas turbine flue gas - the high heat available, CapsolGT® ensures surplus energy, translating to reduced operational expenses.

CapsolGT® replaces the traditional steam cycle, reduces complexity, and introduces carbon capture as a revenue source. It achieves over 95% CO<sub>2</sub> capture rate, streamlining implementation with minimal adjustments and without the need for extra fuel for heat generation.

Positioned as a commercially available, sustainable solution, CapsolGT® signifies a leap towards carbon-neutral energy practices.

## HOW IT WORKS

Highly efficient open cycle gas turbines provide low CO<sub>2</sub> concentrated, hot flue gas streams with temperatures typically around 500-600 °C.

Before entering the core of the capture cycle, the flue gas heat is recovered, utilising a pressurised clean gas absorber stream to generate an overall surplus of electricity. Compared with a typical combined cycle gas turbine plant (CCGT), with end-of-pipe carbon capture, CapsolGT® provides a low cost, less complex and high capture rate alternative. The overall cooling demand is also lower, and the capture plant is able to provide valuable heat 30-105 °C, if required.

The steam required for the capture process is exclusively generated within the CapsolGT® by the means of electricity. CapsolGT® therefore avoids the costly investment into a separate steam boiler and an additional end-of-pipe carbon capture system, as would be required for combined cycle gas turbine power plants (CCGT).

With less equipment, lower external cooling requirements and water neutrality, CapsolGT® achieves higher overall plant efficiencies, and can operate without ongoing supply of external steam and water. In fact, significant amounts of water and waste heat can be accumulated and utilised within the system, for example for external steam production or water supply.

Based on initial studies, CapsolGT® has the potential to make carbon capture from gas power plants a new revenue stream.





CARBON AMERICA

FROSTCC™



ashleigh.ross@carbonamerica.com

www.carbonamerica.com

SUMMARY

Carbon America's patented cryogenic point-source carbon capture technology, FrostCC™, stands to significantly enable rapid decarbonisation across industrial and power sectors. The innovative cryogenic approach utilises standard industrial turbomachinery, similar to air compressors and expanders, and eliminates solvents, chemicals, and water use. It achieves 99% CO2 capture and additionally captures other pollutants like NOx, SOx, heavy metals, and particulates. The commercial FrostCC product will leverage commodity equipment and materials proven at scale in versatile, standardised trains, enabling high volume manufacturing to drive down costs. Its small footprint and electric-only load enables easy retrofitting of existing plants while minimising site host disruption.

BENEFITS

- Maximum Co-Benefits, Minimum Environmental Footprint: Captures 99% of CO2 and NOx, SOx, heavy metals, and particulates while requiring no chemicals, solvents, water, or pre-treatment of the flue gas
Low Cost: Anticipated one of the lowest CapEx of any capture technology with comparable OpEx
Ease of Integration: Utilises a full electric load versus a thermal load, small footprint, and high modularity for easy, minimally-disruptive retrofits
Rapid Deployability: Leverages equipment and materials proven at scale to enable rapid manufacturing of commercial modules, and scale is achieved via replication, enabling massive decarbonisation across sectors with one system architecture
Robust and Reliable: Robust operations regardless of contaminants or operational variability

KEY PROJECTS

- R&D at Arvada, CO Test Facility: Over 350 tests covering over 2000 hours of testing have been performed across a range of concentrations and rates at our laboratory-scale integrated system. Custom, empirically-validated models are continuously refined to characterise the frosting and melting physics, as well as enable scaling and technology enhancement. Testing at Arvada achieved technology readiness level ("TRL") 5 in 2022.
National Carbon Capture Center: An engineering-scale complete system capable of capturing 1,000+ tonnes of CO2 per year using natural gas combustion flue gas has been successfully deployed for 1,000 hours at the National Carbon Capture (NCCC), their first cryogenic capture pilot. This achieved TRL 6 and proves out the full integrated process, enabling progression to design of commercial modules.
Commercial Demonstration Plant Capturing 100 ktpa CO2: Carbon America is pursuing deployment of initial commercial modules in 2028, achieving TRL 8 to 9. Multiple locations and funding options are in consideration; host interest welcome.

KEY DATA

Table with 6 columns: TRL, Capture Rate Range (tpd), Energy Consumption (GJ/tCO2), Number of Commercial Plants, Target Industries, etc.

TECHNOLOGY DESCRIPTION

ULTRACLEAN CRYOGENIC TECHNOLOGY

FrostCC™ is a novel cryogenic CO2 capture technology. FrostCC™ compresses, cools, and expands flue gas to the point where the CO2 within it "frosts" (changes phase from gas to solid, also known as desublimation). The CO2 deposits as a solid on the heat exchanger surfaces, and the heat exchangers are periodically cycled to melt the solid CO2 into a transportation-ready liquid. The CO2-lean exhaust gas is circulated back through the system as the auto-refrigerant. Figure 1 shows a simplified process flow diagram (PFD) of the FrostCC™ system.

The FrostCC™ system consists of standardised, skid-based modules that can be factory manufactured and shipped to sites for final installation. The FrostCC™ heat exchangers have relatively larger temperature approaches (generally over 10 degrees Celsius) that minimise capital cost relative to competing capture technologies and allow for more robust and flexible operation. FrostCC™ is designed to use conventional equipment based on mature technology (such as gas compressors, expanders, shell and tube heat exchangers, air coolers, piping, valves, and pumps), resulting in a higher probability of achieving both cost and performance targets. Utilising the cooled CO2-lean gas itself as the refrigerant, as opposed to an external cooling loop, simplifies the process, reduces capital costs, and avoids greenhouse gas refrigerants which pose significant environmental risk. Additionally, the system requires no water and is designed to capture flue gas pollutants such as SOx, NOx, and particulate matter.

ADVANCING THE STATE OF THE ART

The FrostCC™ design process fundamentally prioritised minimising technical risk, system cost, and development timeline. Carbon America used first principles-based models to design systems, verify results, and inform techno-economic analyses. The FrostCC™ process was designed to minimise risk where possible by using established or simplified processes and equipment.

FrostCC™ improves upon existing technologies in cost and environmental performance. FrostCC™ systems achieve this by lowering CAPEX through leveraging high-volume factory-manufacturing of full system skids, technologies that have been optimised over many decades (gas turbines and heat exchangers), use of low-cost commodity materials (steel and aluminum), and minimum integration with the existing systems at CO2 sources. FrostCC™ also has low overall OPEX by achieving competitive energy efficiency (parasitic load), lower consumables and lower maintenance. The lower costs, easy installation, and co-pollutant capture, paired with Carbon America's deployment capability, are all anticipated to enable rapid decarbonisation across the United States and worldwide.

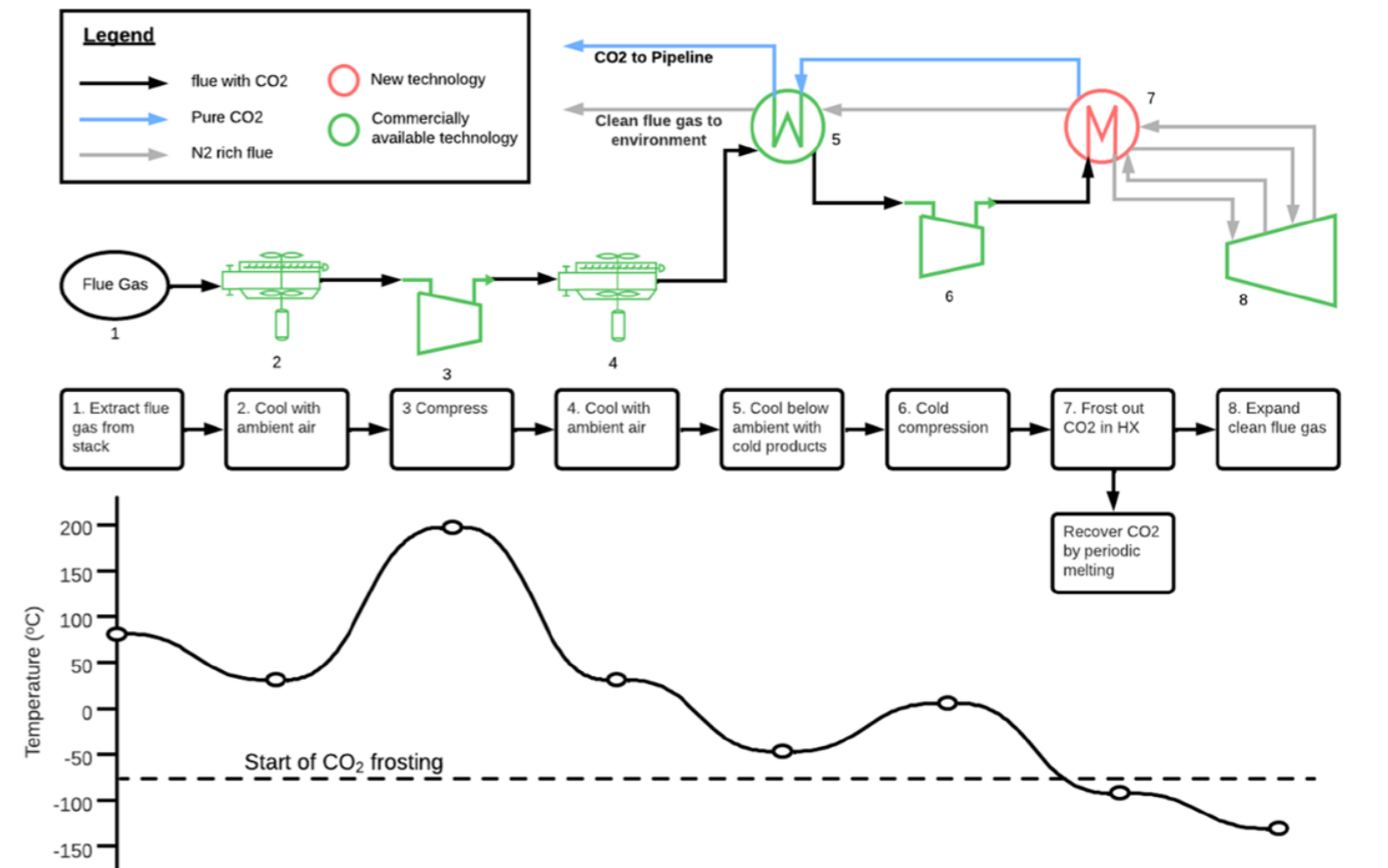



[info@carbonclean.com](mailto:info@carbonclean.com)

[www.carbonclean.com](http://www.carbonclean.com)

## SUMMARY

Carbon Clean is revolutionising carbon capture solutions for hard-to-abate industries, including energy, industrial power, industrial emitters and maritime. The company's patented modular technology significantly reduces the cost of carbon capture when compared to conventional solutions, having amassed 100+ active patent assets to date across 18 patent families covering 30 countries. With technology references in 49 sites around the world, the company has one of the largest project portfolios of any independent carbon capture business.

The company's standardised, point-source CycloneCC technology is accelerating widespread adoption, by overcoming the historical cost and space challenges. This is achieved through reducing the overall cost and physical footprint of carbon capture technology by up to 50% compared to conventional solutions. This breakthrough is achieved by combining two proven process intensification technologies: Carbon Clean's advanced, proprietary amine-promoted buffer salt solvent (APBS-CDRMax®) and rotating packed beds (RPBs). Early adopters stand to benefit greatly from this unique combination.

## BENEFITS

CycloneCC is a modular, columnless, carbon capture solution, ideal for small- to mid-size emitters. Benefits include:

- **Compact and cost-effective:** Process intensification reduces mass transfer equipment by 10 times, decreasing the overall unit footprint by up to 50%.
- **Minimal disruption:** Modular designs and prefabricated skids reduce site infrastructure requirements, easing integration with industrial operations to minimise disruption, cut cost and simplify plant maintenance.
- **Easily scaled:** CycloneCC is delivered in truckable modular units that can be added over time in line with decarbonisation strategies.
- **Standardised designs:** With off-the-shelf base designs and ready-made engineering that is customisable for site conditions, we offer replicable cost and delivery efficiencies.

## KEY PROJECTS

ADNOC selected CycloneCC for a 10 tons per day (TPD) carbon capture pilot at Fertiglobe's plant located in Abu Dhabi, which was installed on site in under a week. The modular technology is also being deployed in North America, while commercialisation of CycloneCC at a capture rate of 100 TPD is under way.

In Sweden, Carbon Clean's technology will be capable of capturing 70,000 tons of biogenic CO<sub>2</sub> per year for Ørsted's FlagshipONE facility, Europe's largest commercial-scale eMethanol facility under construction. FlagshipONE will supply up to 55,000 tons of eMethanol per year to the shipping industry, which today accounts for around 3% of global greenhouse gas (GHG) emissions.

Carbon Clean is also active in the maritime sector, partnering with SAMSUNG E&A to optimise CycloneCC for use onboard ships.

## KEY DATA

TRL	6 - 9 <sup>1</sup>	Capture Rate Range (tpd)	75 - 855 per CycloneCC train	Modular (Y/N)	Yes
Source CO <sub>2</sub> Purity Range	3 - 20 mol%	Energy Consumption (GJ/tCO <sub>2</sub> )	Varies with source CO <sub>2</sub> purity	Capture Efficiency (%)	90%+
Number of Commercial Plants	49 <sup>2</sup>	Number of Pilot Plants	2 CycloneCC units		
Target Industries	Energy, industrial power, industrial emitters (cement, steel and energy from waste) and maritime				

<sup>1</sup> CycloneCC TRL 6 since 2021 and now operating at TRL 7. CaptureX TRL 9.

<sup>2</sup> Comprises CaptureX semi-modular technology and proprietary APBS-CDRMax and APBS-CARBex solvent references (RNG upgrading/biogas).

## TECHNOLOGY DESCRIPTION

CycloneCC is a breakthrough cost-effective, space-saving solution. The 'Lego-block', 'plug and play' modular design enables small-to-midsize industrial emitters to stagger their carbon capture investment. Units are optimised for industrial emissions and can capture between 75 - 855 TPD of CO<sub>2</sub> per train.

The technology to catalyse the deployment at these sites is now ready and process intensification and standardization are key.

At the heart of this innovative technology are rotating packed beds, which use centrifugal force to increase the efficiency of the carbon capture process.

CycloneCC intensifies the traditional solvent capture process by combining two proven process intensification technologies:

1. Rotating packed beds (RPBs) process equipment technology
2. Proprietary amine-promoted buffer salt solvent technology

### ROTATING PACKED BEDS

The APBS-CDRMax® solvent is extremely effective in capturing CO<sub>2</sub>, while the rotating packed beds (RPBs) provide a highly efficient environment for both CO<sub>2</sub> absorption and solvent regeneration, utilised effectively for post-combustion CO<sub>2</sub> capture.

RPBs contain a disk of packing material which rotate about their axis. This generates a centrifugal force significantly higher than the force of gravity relied on by conventional columns with packing, while more effective in the mass transfer of CO<sub>2</sub> from flue gas to solvent.

Under greater force, the droplets and solvent films that form on the bed's packing material are substantially finer than in conventional columns, increasing the available surface area of solvent for a given volume. This results in faster and higher mass transfer efficiency between the gas and liquid phases.

The dramatic improvement in absorption efficiency allows the RPB to be 10x smaller than a traditional column, achieving the same results. The combination of RPBs and the APBS-CDRMax® solvent provides:

- Smaller equipment sizes at equivalent performance – using RPBs in the absorber/stripper results in more than one order of magnitude reduction in equipment size.
- Better mass and heat transfer between the liquid and gas phases through thinner liquid films produced by a centrifugal force.
- More intense turbulent flow relative to conventional columns.

The APBS-CDRMax® solvent in the stripper RPB also reduces heat requirements and improves efficiency of heat transfer, collectively reducing the cost of regenerating solvents. Additionally, degradation and corrosion rates are lowered, unlocking savings in solvent make-up and waste disposal, while energy efficiency is improved by the reduced need to pump coolant around the unit.

Further optimisation is achieved using digital twin technology, enabling CycloneCC units to be operated remotely to deliver improved plant and energy efficiency.

In addition, reduced total installed cost makes it possible to incorporate CycloneCC units into existing and future operations, enabling businesses to scale their carbon capture over time, meeting crucial targets and reducing their carbon emissions sooner.

### APBS-CDRMAX® SOLVENT

Carbon Clean's APBS-CDRMax® solvent is formulated to optimise carbon capture performance. Its innovative, patented formulation of amines and salts – amine-promoted buffer salts (APBS) – offers both the high kinetic reactivity of an amine and the low regeneration energy of a buffer salt. The result is a unique, fast-acting, high-capacity solvent that delivers higher performance in any solvent-based carbon capture system.

The solvent chemistry allows for rapid removal of carbon dioxide from flue gases with CO<sub>2</sub> concentrations ranging between 3% and 20% by volume. APBS-CDRMax® produces CO<sub>2</sub> with a purity of ≥99.5% by volume on a dry basis. It reduces regeneration energy requirements and provides both greater stability and lower corrosivity than conventional solvents. Comprehensive testing has validated the real-world benefits of APBS-CDRMax® including:

- 20x less corrosion and 10x less degradation than conventional solvents.
- A reduction in solvent emissions to parts per billion (ppb) levels, which meets environmental regulatory requirements and facilitates approvals.
- 10% to 25% lower energy demand for the capture and regeneration process.
- 5x longer solvent life and 86% less solvent make-up.

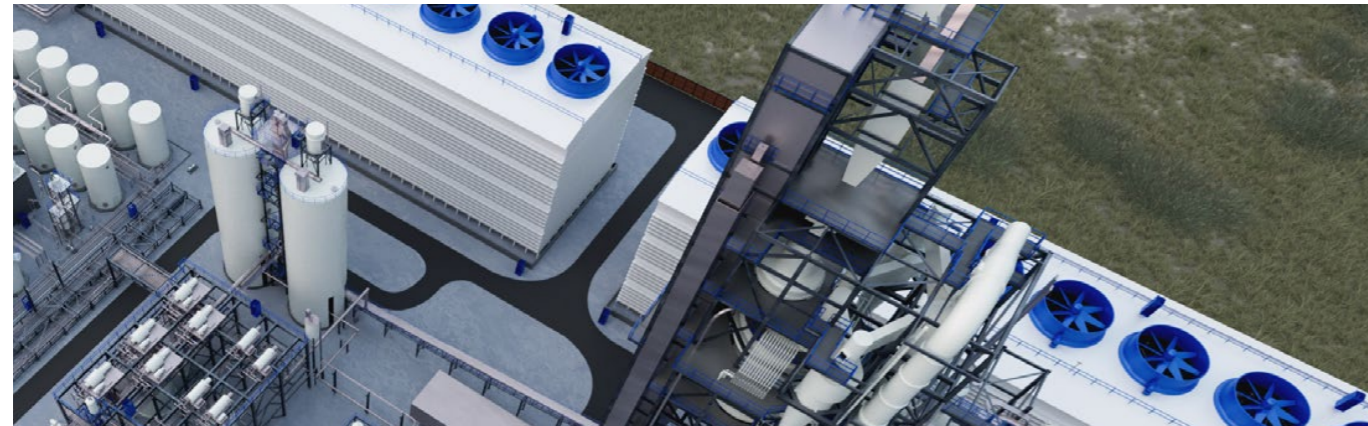

[info@carbonengineering.com](mailto:info@carbonengineering.com)

[www.carbonengineering.com](http://www.carbonengineering.com)

**SUMMARY**

Direct Air Capture (DAC) is a technology that captures carbon dioxide CO<sub>2</sub> directly from the atmosphere with an engineered system. This is similar to how trees absorb CO<sub>2</sub> for photosynthesis, except DAC does it much faster, with a much smaller land footprint, and delivers the CO<sub>2</sub> in a concentrated, compressed form. The captured atmospheric CO<sub>2</sub> can then be safely stored in geologic reservoirs to deliver negative emissions, or used to produce low carbon intensity products, such as diesel and aviation fuel, that work in existing aircraft and infrastructure.

More than a decade ago, Carbon Engineering (CE) pioneered a liquid sorbent-based DAC system that can be optimised for scale. STRATOS, the first commercial-scale facility to use CE’s technology, is currently under construction in Texas and, when fully operational, is expected to be the largest in the world.

**BENEFITS**

- **Scalable.** Industrial facilities that use CE’s DAC technology can be built in one or more trains.
- **Standardised design.** Alongside its partners, we bring a standardised ‘design one, build many’ approach to deployment, working to duplicate near identical plants adjusted for location specific considerations. This helps support the rapid build-out of large-scale facilities.
- **Industrial precedent.** At CE, we’ve built our DAC technology by combining existing equipment and processes that are widely used across other industries, and then innovating, adapting, and integrating them to create our DAC system. This means our system can be built at industrial scales largely with existing supply chains.
- **Closed chemical cycle.** Our DAC technology captures CO<sub>2</sub> from the air in a “closed loop” system, which means CE is able to re-use the chemicals with minimal waste.

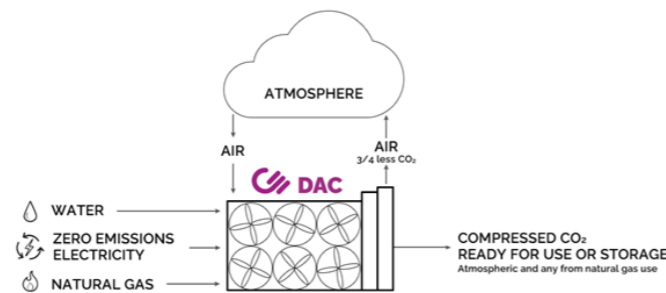

**KEY DATA**

TRL	Not Reported <sup>1</sup>	Capture Rate Range (tpd)	~	Modular (Y/N)	~
Source CO <sub>2</sub> Purity Range	~	Energy Consumption (GJ/tCO <sub>2</sub> )	~	Capture Efficiency (%)	~
Number of Commercial Plants	~	Number of Pilot Plants	~	Feed Gas O <sub>2</sub>	~
Target Industries	DAC				

<sup>1</sup> While not reported, meets Technology Compendium submission requirements for a TRL greater than 5. With the first commercial facility under construction and designed to capture 500,000 tonnes of CO<sub>2</sub> per year when fully operational, TRL estimate closer to 8

**TECHNOLOGY DESCRIPTION**

DAC technology captures CO<sub>2</sub> by pulling in atmospheric air. Then, through a series of chemical reactions, CO<sub>2</sub> is extracted from the air while returning the rest of the air to the environment. DAC is a different, and complementary, technology to point-source carbon capture and storage, which removes CO<sub>2</sub> from industrial flue gas instead of the atmosphere. Within hub or cluster CO<sub>2</sub> storage projects, DAC can bring important value by delivering CO<sub>2</sub> capacity with relatively stable purity and supply.

CE’s DAC technology approach is focused on achieving large, industrial scale at low cost. To help achieve this, CE’s solution utilises existing and widely used equipment and processes from other industries, innovating and integrating them to deliver a DAC system based on largely known supply chains, and reliable equipment costs. Our process begins with an air contactor that is adapted from industrial cooling towers to bring in high volumes of air, which passes across thin plastic surfaces that have potassium hydroxide solution flowing over them. This potassium hydroxide binds with the carbon dioxide molecules, removing them from the air and trapping them in the solution in the form of a potassium carbonate salt. Then, through a series of processes in the regeneration step, the CO<sub>2</sub> is concentrated and compressed into a near pure stream ready for use or storage.

To help minimise waste and consumables across CE’s process, the DAC technology uses chemical reactions in a closed loop system to absorb CO<sub>2</sub> from the air (see below). There are a number of applications for atmospheric CO<sub>2</sub> captured through DAC, but CE is focused on delivering two types of industrial solutions:

1. Carbon Dioxide Removal – When paired with secure geologic storage, DAC can deliver durable and verifiable removal of CO<sub>2</sub> from the atmosphere. This provides a mechanism to help hard-to-decarbonise sectors, like aviation and maritime, address their emissions faster and at a lower cost than many existing mitigation solutions. In the future, in a post net-zero world, these same facilities could be used to address legacy emissions, creating an opportunity for climate restoration.
2. Low-carbon fuel – CE’s AIRTOFUELS™ solutions can enable captured atmospheric CO<sub>2</sub> to be combined with hydrogen to produce low carbon intensity fuel that is drop-in compatible with existing vehicles and infrastructure.

**DEPLOYMENT APPROACH**

CE leverages partnerships and cross-industry collaboration to enable the rapid and widespread deployment of DAC infrastructure at scale. CE and 1PointFive – both subsidiaries of Occidental Petroleum Corporation (Oxy) - bring a standardised ‘design one, build many’ approach to deployment. This approach combines DAC technology, large-scale carbon dioxide management, project experience and extensive storage infrastructure. CE will provide the DAC technology, while 1PointFive, together with Oxy affiliates, builds and deploys the DAC plants, leveraging Oxy’s strong project engineering and delivery expertise. This helps support the rapid build-out of large-scale facilities, which can be designed with location-specific considerations.

**CARBON ENGINEERING’S INNOVATION CENTRE**

Built in 2021, CE’s Innovation Centre (CEIC) in Squamish, B.C. provides an environment where our engineers and technicians conduct ongoing technology development, testing, and analysis. This CEIC enables CE to continue optimising our DAC technology to drive down the cost of capture per tonne. The facility contains all the major components of commercial-scale DAC facilities so engineers can test and validate technology enhancements in an integrated system. The next generation technologies developed here in Squamish will then be introduced to commercial facilities worldwide to help drive down emissions and achieve net zero targets.

**COMMERCIAL FACILITIES UNDERWAY**

STRATOS, the first commercial facility to use CE’s DAC technology – being developed by 1PointFive – is under construction in the United States. This first-of-its-kind facility is designed to be capable of extracting 500,000 tonnes of atmospheric CO<sub>2</sub> annually once fully operational. Engineering is underway for a DAC facility at a second site in Kleberg County, Texas, which was selected to receive a grant from the US. Department of Energy in 2023. Using the “design one, build many” approach, the site is expected to provide access for the potential construction of multiple DAC facilities that could be capable of collectively removing up to 30 million tonnes of carbon dioxide from the atmosphere annually for dedicated sequestration. This work provides a blueprint for global projects, supporting the design of additional facilities already progressing in multiple markets around the world. Please contact CE if you are interested in large-scale Direct Air Capture technology or building new, clean-infrastructure projects in your jurisdiction.



# NEXT GENERATION CARBON CAPTURE TECHNOLOGY



[info@c-capture.co.uk](mailto:info@c-capture.co.uk)

[www.c-capture.co.uk](http://www.c-capture.co.uk)

## SUMMARY

C-Capture’s proprietary, solvent-based technology is a true innovation in – and game-changer for – carbon capture.

The company’s patented solvent-based technology selectively removes CO<sub>2</sub> from a mixed gas stream. Well suited to the large-scale capture of CO<sub>2</sub>, it can be deployed on most processes requiring CO<sub>2</sub> separation from other gases.

Based on fundamentally different chemistry to current commercially available approaches, C-Capture’s solution is amine free and environmentally benign. It is also lower cost, extremely robust and suitable for use within difficult-to-decarbonise industries – including cement and glass manufacturing, and energy from waste.

The advantages of C-Capture’s decarbonisation technology mean it can break through the barriers that are currently preventing the widespread adoption of carbon capture – and make a globally significant contribution to reaching net zero.

## BENEFITS

- A novel approach that is amine free, C-Capture’s solvent is naturally degradable and environmentally benign.
- C-Capture’s process releases CO<sub>2</sub> more readily than amine-based systems, resulting in significantly lower parasitic energy demand.
- Significantly reduced process energy requirements (~1.8 GJ/tonne CO<sub>2</sub>) due to low steam requirements and reduced costs of compression due to higher CO<sub>2</sub> release pressure.
- Suitable for use in industries that are difficult to decarbonise with a proven high tolerance to flue gas impurities, particulates, and acid gases such as NO<sub>x</sub> and SO<sub>x</sub>.
- Reduced need for feed-gas pre-cleaning.
- Significantly less corrosive than amine-based equivalents. Reduced operations and maintenance costs.
- Lower solvent management costs due to high thermal, chemical, and oxidative stability, and low volatility, which minimises solvent losses per tonne of CO<sub>2</sub> captured.



## KEY DATA

TRL	7	Capture Rate Range (tpd)	1.0 - 1.4	Modular (Y/N)	N/A
Source CO <sub>2</sub> Purity Range	N/A	Energy Consumption (GJ/tCO <sub>2</sub> )	~1.8	Capture Efficiency (%)	>90%
Number of Commercial Plants	0	Number of Pilot Plants	3		
Target Industries	C-Capture’s technology is suitable for use within most applications requiring CO <sub>2</sub> separation. Current focus is on biogas and hard-to-abate industries such as energy from waste, glass and cement.				

## TECHNOLOGY DESCRIPTION

### NEXT-GENERATION INNOVATION

An innovative UK cleantech company, C-Capture has been at the forefront of developing carbon capture technology for over a decade.

The company was created as a spin-out from the University of Leeds when Founder, Professor Chris Rayner’s progressive work in finding new solutions to the carbon capture problem attracted investment.

Amine free, our technology has distinct chemical properties which use significantly less energy than traditional approaches. C-Capture’s solvent components are all highly thermally stable. This achieves higher desorber temperatures, creates greater CO<sub>2</sub> pressures on release, and reduces the compression energy to prepare CO<sub>2</sub> product for transport and storage.

C-Capture’s robust solvent is highly resistant to oxidation and ageing, making it suitable for industrial applications that traditional amine-based solvents cannot address (without significant additional capital investment, complexity, and risk). This resistance also leads to longer solvent life, further reducing costs.

### ACCELERATING THE DEPLOYMENT OF CARBON CAPTURE TECHNOLOGY

C-Capture is demonstrating the compatibility of our technology within several hard-to-abate industries as part of our pioneering XLR8 CCS project.

Carbon capture solvent compatibility units (CCSCUs) are being installed and operated within energy from waste, glass and cement manufacturing industries as part of the project. These will complete a total of six carbon capture trials, demonstrating that a low-cost carbon capture solution is a reality for difficult-to-decarbonise industries in the race to net zero.

A fully automated and containerised, small scale carbon capture plant that runs on real flue gas, each CCSCU replicates the temperatures, pressures, and solvent composition changes that would be found in a full-scale capture cycle. Recreating real-world process conditions, but in a low resource intensity manner, C-Capture’s CCSCUs rapidly gather high-quality data to quantify online solvent loss and degradation rates within specific applications.

XLR8 CCS has already achieved the UK’s first demonstration of a carbon capture technology within the mainstream commercial glass manufacturing industry. The project will launch an innovative carbon capture trial in the cement manufacturing industry later this year.

‘XLR8 CCS – Accelerating the Deployment of a Low-Cost Carbon Capture Solution for Hard-to-Abate Industries’ is supported by £1.7m in funding from the UK Government’s Net Zero Innovation Portfolio (NZIP). The funding is part of the £20 million Carbon Capture, Usage and Storage (CCUS) Innovation 2.0 programme which is aimed at accelerating the deployment of next-generation CCUS technology in the UK.

### ROBUST TECHNOLOGY

Another of C-Capture’s CCSCUs has achieved over 800 hours of operation on real-world flue gases within an additional hard-to-abate industry. The results are consistent with the company’s in-lab testing, yielding consistent ageing data that demonstrates a high tolerance to impurities, low solvent degradation rates and proves the robustness of C-Capture’s solvent.

### BECCS – A WORLD FIRST

C-Capture’s technology was deployed to pilot the first bioenergy carbon capture storage (BECCS) project of its kind in Europe, at the UK’s largest source of renewable power by output, Drax Power Station in North Yorkshire, UK.

Successfully proving that C-Capture’s proprietary solvent can isolate CO<sub>2</sub> from the flue gases that are released when biomass is used to generate electricity, the pilot was the first time in the world that CO<sub>2</sub> had been captured from the combustion of a 100% biomass feedstock. A major milestone for carbon capture and for achieving negative emissions through BECCS.

The company’s work continues at Drax as we progress to commercialisation. The current pilot plant has been designed to capture between 1 and 5 tonnes of CO<sub>2</sub> a day. Currently operating on synthetic flue gas (air/CO<sub>2</sub>), the pilot incorporates every unit operation and control mechanism that will be present in a full commercial unit, exploring and testing each element of C-Capture’s process in a highly controlled environment. Data will provide proof of C-Capture’s performance metrics and how the technology can work within customers’ specific industries, along with techno-economic evaluations as part of the consulting process.

The pilot has over 2,000 hours of operation in representative conditions to date, achieving capacity at 1.0 to 1.4 tpd CO<sub>2</sub> capture rate at 90% capture fraction from representative synthetic flue gas for BECCS (15%v) and cement (18%v).

In addition, a CCSCU has been carrying out a lifetime test on the biomass-derived flue gas from Drax’s boilers. The results to date, combined with data previously gathered from laboratory testing, indicate that C-Capture’s technology is highly compatible with biomass flue gas.

C-Capture’s first commercial demonstration unit, which will showcase the company’s transformational carbon capture technology at an industrially relevant scale (50- 200 tonnes CO<sub>2</sub> capture per day), is due to be announced shortly.

# AMINE CAPTURE PLANT SYSTEM FOR LARGE SCALE CAPTURE



✉ 12000185@ceic.com

## SUMMARY

To achieve low-cost and long-term operation, great efforts have been taken in the research fields of novel highly-efficient ternary composite amine absorbent, optimised integration between carbon capture and power generation system, amine-loss control technology, new packing, intelligent control technology, and optimised design for large-scale key equipment. This technology has been applied in the 500 kt/a carbon capture project for Taizhou coal-fired power plant of CHN Energy, currently the largest in Asia and the third-largest coal-fired power plant carbon capture project worldwide. Significant breakthroughs have been achieved in the innovation of key core carbon capture technologies, and as a result, the operational indicators demonstrate the superiority of this project, with the carbon capture rate 90.86%, the capture heat consumption 2.35 GJ/tCO<sub>2</sub>, and the capture electricity consumption 51.5 kWh/tCO<sub>2</sub>, according to the test report by the China National Institute of Metrology.

## BENEFITS

- **Social Benefits:** Promote continuous innovation and development in carbon capture technology for industrial appliance. Additionally, actively respond to China's "carbon peak and carbon neutral" strategy, promote the reduction of CO<sub>2</sub> emission in the coal-fired power industry, and effectively address climate change challenges. Furthermore, increase public awareness of environmental protection, advance clean energy technologies and foster sustainable development.
- **Economic Benefits:** By employing efficient energy-saving equipment and optimising processes, construction and operating costs are significantly reduced while the project achieves energy-saving and emission reduction goals. Based on the local urban planning, this project fully utilises existing resources, scientifically plans layouts, and maximises the conservation of land, energy, and water resources, thereby promoting the local socio-economic development.
- **Awards:** Top Ten Scientific and Technological Innovations in the Energy Industry of 2023" by Chinese National Energy Administration.

## ACHIEVEMENTS

- **Absorbent:** Create a ternary composite amine absorption system with high capacity, low volatility, and degradation resistance. Develop techniques for resistance of amine oxidation and purification of heat stable salts.
- **System Integration:** Propose methods for the efficient utilisation of energy in large-scale carbon capture and power generation systems, and form deeply integrated designs for coal-fired power plants, incorporating steam, heat, and electricity.
- **Amine-Loss Control:** Develop technologies for dry-bed cooling condensation and spray aggregation, along with novel dry-method condensing and amine recovery devices, and composite blade gas-liquid separators.
- **New Packing:** Invent regularised packing with small tooth to suppress liquid phase deviation on packing surfaces and reduce kinetic energy consumption from gas flow collision in the packing layer.
- **Intelligent Control:** Develop intelligent control technology for carbon capture and power generation systems, enabling one-click start-stop functionality and intelligent, manpower-saving operation, ensuring operational metrics and system safety.

## KEY DATA

TRL	7	Capture Rate Range (tpd)	~	Modular (Y/N)	Yes
Source CO <sub>2</sub> Purity Range	~15%	Energy Consumption (GJ/tCO <sub>2</sub> )	2.35	Capture Efficiency (%)	>90
Number of Commercial Plants	1	Number of Pilot Plants	2		
Target Industries	Power Generation				

## TECHNOLOGY DESCRIPTION

### KEY TECHNOLOGICAL INNOVATIONS

#### Absorbent Research and Development

CO<sub>2</sub> absorbent is the basis for large-scale carbon capture. A novel absorbent with low regeneration energy consumption and minimal losses has been developed through functional group design and solvent matching. Considering the different characteristics (such as absorption capacity, absorption and desorption rate, degradation resistance) of various organic amines, research team take great efforts to select the optimised components and adjust each ratios. Finally, an innovative method has been developed for synthesising a novel ternary composite amine absorbent with optimal comprehensive performance, possessing independent intellectual property rights, along with mastery of large-scale preparation processes. The superiority of this novel absorbent is demonstrated through comparative results in the laboratory analysis and tests on pilot and industrial-scale carbon capture facilities. The results indicate that the novel absorbent has a circulation load of 41 L/L, and compared to 30wt% MEA, the regeneration heat consumption is reduced by 26.5%, the degradation rate is decreased by 41.2%, and the reduction of unit cost is more than 30%. These features significantly reduce the operational energy consumption and costs of carbon capture systems. According to current operational data, the capture heat consumption is 2.35 GJ/tCO<sub>2</sub>, the amine degradation loss rate maintains low levels, and the system has been stably operated for 300 consecutive days, therefore greatly reducing capture costs.

#### Key Equipment Research and Optimisation

This project employs innovative stainless steel small-tooth, high-efficiency packing. The reduction of the top angle of the tooth effectively mitigates liquid phase deviation, lowers cross-flow ratio, and significantly enhances the liquid phase's coverage area and gas-liquid mass transfer flux on the packing surface. Compared to conventional packing, it reduces pressure drop by 30%, increases mass transfer efficiency by 10%, and substantially cuts down investment and energy consumption for the absorption tower. Further advancements include specialised mass transfer separation elements and optimised distributor distribution within the tower. The integrated oil collection tank with beam groove provides ample ventilation area, minimising resistance, pressure drop, and fan energy consumption while improving absorption efficiency and operational stability for large-scale units, consequently reducing energy consumption and solvent loss.

Moreover, the project introduces a pioneering dry method amine recovery device. Through cooling, condensing, and agglomeration in the dry bed section, followed by water washing and demisting, the amine emissions are effectively controlled, thus addressing issues of excessive amine escape and high operating costs.

#### Integrated and Large-Scale Production Processes

In terms of process design, to further reduce absorbent loss and operating costs, the operating parameters are optimised, such as liquid-to-gas ratio, the temperature

of inter-stage cooling, and the parameters of diversion desorption process. As a result, the electricity consumption of carbon capture system is significantly decreased, monitored to be reduced to about 51.5 kW/tCO<sub>2</sub>. Compared to the typical 90 kW/tCO<sub>2</sub> in general carbon capture systems, this marks a 42.7% decrease in unit capture electricity consumption.

Regarding the integration of thermal system, deep optimisation is conducted between carbon capture and power plant thermal systems. Steam required for desorption reactions is drawn from steam turbine-driven forced draft fans exhaust, and steam condensate is recovered to the unit's low-temperature economiser, achieving full heat recovery and enhancing the economic viability of the coal-fired power plant with carbon capture.

Concerning the carbon capture control system, an intelligent control strategy is established, featuring functions such as APS one-click start-stop and overall control optimisation for single and multiple objectives. This enables intelligent, manpower-saving operation, significantly enhancing device safety.

## GENERAL INTRODUCTION OF TAIZHOU CCUS PROJECT

In order to achieve "carbon peak and carbon neutral" target, the 500 kt/a carbon capture project for Taizhou coal-fired power plant was approved and initiated by CHN Energy in 2021, and was organised by CHN Energy's Jiangsu company, with Taizhou Coal-Fired Power Plant responsible for implementation and New Energy Technology Research Institute managing overall technical work.

The project utilises chemical absorption to capture carbon dioxide. Flue gas undergoes washing, absorption, and regeneration in succession to obtain high-concentration regeneration gas, which is then compressed, dried, liquefied, and purified to produce liquid CO<sub>2</sub> products. This demonstration project is the first to exceed 200 kt/a in China for a coal fired power plant, and the technical R&D team has faced up to the key challenges in preliminary research, process design and equipment development. As a result, technological innovations are achieved throughout the whole chain of large-scale carbon capture system, including novel amine absorbent, key equipment, system integration and intelligent control.

## FUTURE OUTLOOK

The CO<sub>2</sub> capture capacity of this project is approximately 1/8 of a 1000 MW unit. To spearhead the development of carbon capture in thermal power generation, CHN Energy is planning the Taizhou Power Plant's 1000 MW unit integrated carbon capture project with scales of 4 million tons annually. Based on the current technologies, the new project will focus on key technological research and development in absorption techniques, critical equipment, control optimisation, utilisation and storage, as well as demonstration operations, with the purpose of driving the low-carbon transformation of the energy industry and contributing to global climate change mitigation efforts.

# CO2SORB – EFFICIENT HIGH-PRESSURE CO<sub>2</sub> CAPTURE



JaiKant.Pandit@co2crc.com.au

www.co2crc.com.au

## SUMMARY

Natural gas serves as an energy source and a vital feedstock for various industries. Production of natural gas presents the challenges of separating CO<sub>2</sub> at high pressure. At high pressure, the performance of the pressure swing adsorption (PSA) process drops due to a reduction in the selectivity and capacity of adsorbents.

Novel adsorbent CO2Sorb from CO2CRC and its research partners demonstrated a significant improvement in CO<sub>2</sub> working capacity and selectivity over the original parent material, under the feed pressures of up to 50 bar and CO<sub>2</sub> concentrations of 7 - 40%. Thus, CO2Sorb adsorbent enables the PSA system to handle 3 to 4 times higher flow rates or reduces the size of the PSA unit, up to a third or a quarter compared to units using the parent material at the same feed flow rate. Additionally, the improved selectivity of CO2Sorb allows for more effective separation between CO<sub>2</sub> and methane, leading to increased methane revenue and reduced CO<sub>2</sub> and methane emissions. Therefore, CO2Sorb is ideal for integration into PSA systems for CO<sub>2</sub> capture from natural gas or high pressure CO<sub>2</sub> separation.

## BENEFITS

CO2CRC's CO2Sorb adsorbent has been developed to remove CO<sub>2</sub> efficiently from high-pressure natural gas. Here are the major benefits of CO2Sorb:

- CO2Sorb is a robust material with high working capacity, making the PSA process more compact than commercial adsorbents.
- High selectivity of CO2Sorb provides high purity of methane-rich and CO<sub>2</sub>-rich streams, significantly reducing the methane loss. Thus, it provides better OPEX and reduces greenhouse emissions due to both methane and CO<sub>2</sub>. Moreover, more revenue can be achieved with less methane loss (higher methane production).
- Lower footprint and lower energy requirements for regeneration as compared to the solvent technology.
- With demonstrated performance at 50 bar, CO2Sorb had the potential to take advantage of the high pressure of raw natural gas from the gas well and reduce the compression energy requirements downstream.
- CO2Sorb is non-toxic and non-hazardous and, unlike amine-based solvents, does not lead to the corrosion of the equipment.

## KEY DATA

TRL	4 - 5	Capture Rate Range (tpd)	Depends on CO <sub>2</sub> % in the gas and gas pressure 0.01-0.025	Modular (Y/N)	Yes
Source CO <sub>2</sub> Purity Range	7% to 40%	Energy Consumption (GJ/tCO <sub>2</sub> )	Depends on CO <sub>2</sub> % in the gas and gas pressure	Capture Efficiency (%)	>70% - Can be higher if run in series
Number of Commercial Plants	0	Number of Pilot Plants	1		
Target Industries	Potential for high pressure (up to 50bar) CO <sub>2</sub> capture from oil and gas and/or hydrogen operations. Can be applied for pre-combustion emission and post combustion emission.				

## TECHNOLOGY DESCRIPTION

The performance of the adsorption technology depends on the ability of the adsorbent surface to adsorb the desired gas from the gas mix selectively and the adsorbent's ability to desorb the gas with the change of conditions, e.g. temperature (temperature swing), pressure (pressure swing) or moisture (moisture swing). For natural gas processing, separation of hydrogen from syngas, the pressure swing adsorption (PSA) takes advantage of the high pressure of the gas streams. Thus, for high-pressure applications, the adsorption process provides significant energy savings with respect to conventional amine-based absorption. The development of CO2Sorb targets to reduce the CAPEX and OPEX of the CO<sub>2</sub> capture process. In addition to working capacity and selectivity, physical properties (hardness and stability under cyclic operations) are important, as shown in Figure 1.

## TECHNOLOGY DEVELOPMENT

CO2CRC's research and development program for CO<sub>2</sub> separation from natural gas started in 2016 in collaboration with its research partner. The adsorbents were compared based on a few performance criteria such as material cost, isotherms, capacity, and selectivity for application in high pressure natural gas. Sorbead WS was selected to be the benchmark adsorbent for a stage-gated Otway Capture Project at CO2CRC's Otway International Test Centre (OITC) for field testing with natural gas from a buttress well at OITC.

A new process recipe was developed to produce the novel adsorbent material CO2Sorb with the size, shape, packing density, crushing strength, adsorption capacity and selectivity. All CO2Sorb samples were developed and characterised in the lab environment. CO<sub>2</sub> and CH<sub>4</sub> isotherms were measured using volumetric apparatus (ASAP 2050, Micrometric, USA). BET surface area, pore width distribution and volume of CO2Sorb were determined by measuring N<sub>2</sub> isotherm at the temperature of 77 K (-196.15°C) with 3Flex. The adsorbent structure was characterised with X-ray Powder Diffraction (XRD) and element analysis within the adsorbent samples was conducted using energy-dispersive X-ray spectroscopy (EDS).

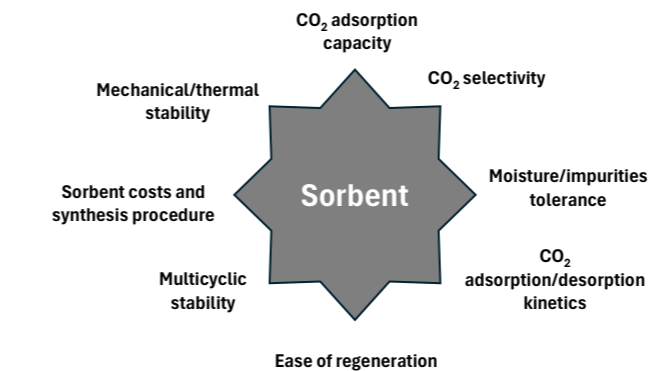

Figure 1

## IMPROVED PERFORMANCE

The measured isotherms of CO<sub>2</sub> and CH<sub>4</sub> for the scaleup sample (Figure 2) indicate much higher working capacity compared with the benchmark commercial material, Sorbead. The better adsorption characteristic means using the developed material can potentially reduce capital costs via smaller equipment and less material.

Four CO2Sorb samples were studied for four different feed CO<sub>2</sub> concentrations ranging from 10-40%. The working capacity and selectivity were calculated based on 30% CO<sub>2</sub> feed concentration at 50 bar and desorption pressure at 1 bar with 95% CO<sub>2</sub>. Test results showed that the CO2Sorb series achieved much higher CO<sub>2</sub> working capacity and selectivity than Sorbead and previous generation CO2CRC's adsorbent, Otway HY (Figure-3). The binary selectivity for all samples was calculated to be greater than 1, indicating that the PSA process is suitable for the gas separation application.

## NEXT STEPS

After establishing a superior performance of CO2Sorb, the next step is to scale up the pilot testing of CO2Sorb adsorbent in a full PSA system, progressing to a higher TRL level up to commercialisation. The CO2Sorb formulation and testing can also be expand to other potential applications in syngas treatment, which is commonly used in the blue hydrogen production industry, such as from steam methane reforming (SMR) and coal gasification. CO2CRC is looking for potential funding and collaboration opportunities to test and showcase CO2Sorb technology in different industrial applications and environmental conditions.

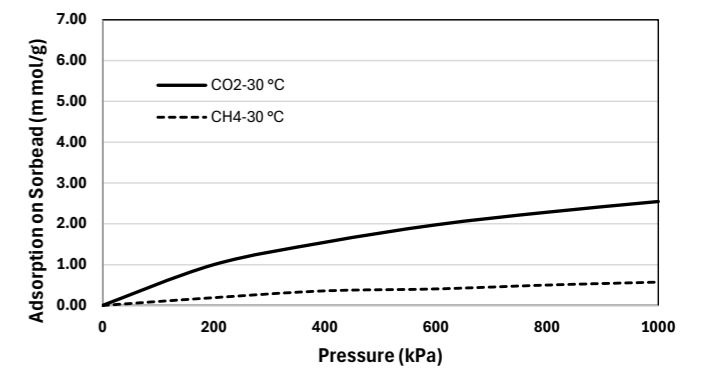

Figure 2

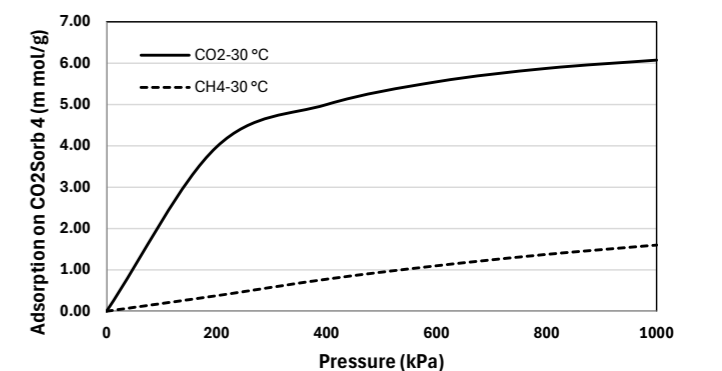
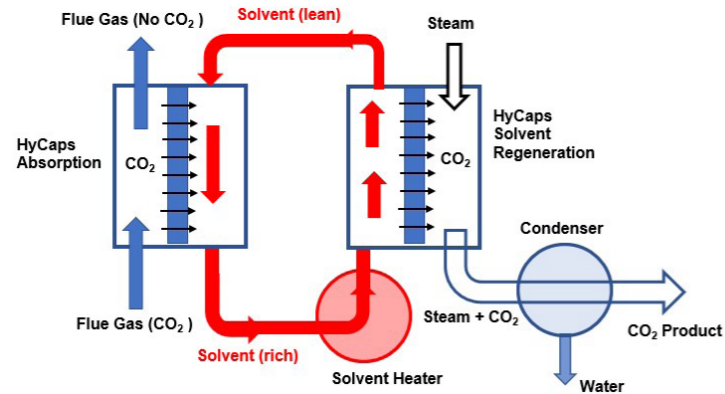

Figure 3



JaiKant.Pandit@co2crc.com.au

www.co2crc.com.au

**SUMMARY**

Operating since 2003, CO2CRC is a world leader in carbon capture, utilisation and storage (CCUS) research. CO2CRC works with national and international discipline leaders, manages interdisciplinary and inter-institutional research projects, has well-established, decade-long relationships, strong international brand recognition, and an outstanding health and safety record. CO2CRC develops and trials next generation low-emission technologies in commercially relevant, first-of-a-kind demonstrations.

CO2CRC Ltd., in collaboration with its research partners in Australia, has developed a hybrid CO<sub>2</sub> capture technology, HyCaps. HyCaps combines solvent absorption and membrane separation in a single process, which exploits the advantages of both technologies to achieve efficient carbon capture. The HyCaps process has proven its ability to be highly efficient at carbon capture with reduced energy requirements. HyCaps is modular and scalable, and its footprint is substantially lower than the conventional amine solvent process for CO<sub>2</sub> absorption, making it suitable for retrofitting existing plants, thereby promoting faster implementation of carbon capture utilisation and storage (CCUS).

**BENEFITS**

HyCaps is a hybrid technology that combines solvent absorption technology with membrane technology. This provides numerous benefits over conventional solvent absorption technology.

- HyCaps modules provide very high surface area to volume ratios. Consequently, the equipment size for carbon capture is significantly reduced compared to conventional solvent absorption columns.
- The separation of the solvent and flue gas streams by the membrane eliminates solvent foaming and flooding and reduces liquid channelling, the major operating issues in conventional solvent absorption. Also, there is no need for solvent redistribution.

- The HyCaps modules can be oriented in any direction without impacting the performance. Lower footprint, flexibility in orientation and modular design enable HyCaps' capture process to be easily accommodated into limited spaces, making the technology ideally suited for retrofit applications as well as for new build designs.
- Solvent regeneration does not require reboiling/phase change, significantly reducing the solvent regeneration energy as compared to conventional absorption.
- HyCaps is a very cost-competitive technology with the potential to reduce CO<sub>2</sub> emissions in the hard-to-abate sectors, oil & gas, onshore and offshore oil and gas platforms, ship-based processes, biogas upgradation and many more.

**KEY DATA**

TRL	6	Capture Rate Range (tpd)	Max. 1.4 tpd /module (depending on CO <sub>2</sub> % in the gas)	Modular (Y/N)	Yes
Source CO <sub>2</sub> Purity Range	>5%	Energy Consumption (GJ/tCO <sub>2</sub> )	depends on CO <sub>2</sub> % in the gas	Capture Efficiency (%)	>90%
Number of Commercial Plants	~	Number of Pilot Plants	3		
Target Industries	Power, industry, oil and gas, hard-to-abate sectors and other post-combustion CO <sub>2</sub> emissions				

**TECHNOLOGY DESCRIPTION**

HyCaps is a hybrid technology that combines mature solvent technology with membrane technology to overcome inherent limitations while retaining or enhancing their advantages – as shown in Figure 1 below.

The flowsheet is similar to that of conventional solvent CO<sub>2</sub> capture systems, but the HyCaps module replaces the conventional packed columns for absorption and solvent regeneration. The process involves the transfer of CO<sub>2</sub> from the gas mix through a hollow-fiber membrane, where it is chemically absorbed into a solvent. In solvent regeneration with HyCaps, the physical separation of the solvent and gas phases by the membrane enables carbon dioxide to be drawn from the enriched solvent phase into the gas phase. This enables solvent regeneration to be achieved at temperatures lower than conventional packed columns, and solvent regeneration can be achieved without vaporisation of the solvent. By avoiding the vaporisation of the solvent, the HyCaps process significantly reduces the energy demand for solvent regeneration.

regeneration, and the low-quality heat/waste heat from the plant can be utilised within the system, making the whole regeneration a low OPEX process. When compared to the conventional solvent process, the operating cost of HyCaps is about 60% lower, as shown in Figure 2.

The Hybrid HyCaps is a new approach to carbon capture technology that offers clear advantages in terms of energy requirement and footprint compared to traditional methods. This technology has been demonstrated at three different industrial pilot plants in Australia. It has proven to be deployment-ready to effectively address carbon emissions from industrial sources, including the hard-to-abate sector. HyCaps is a modular, compact, and scalable solution that can be applied to both post-combustion and pre-combustion CO<sub>2</sub> capture processes. Due to its compact design, flexible orientation, and easy installation, HyCaps is suitable for any industry with limited space, including mobile process platforms such as FPSO and ship-based processes.

**COST EFFECTIVE TECHNOLOGY**

Initial techno-economic analysis done for the CO<sub>2</sub> capture with 18% CO<sub>2</sub> in the flue gas indicates the cost-effectiveness of HyCaps technology. HyCaps modules have 5000-6000 m<sup>2</sup> surface area per m<sup>3</sup> of the volume as compared to 500-800 m<sup>2</sup>/m<sup>3</sup> for the conventional packed columns. As a result, HyCaps modules have a reduced equipment footprint by approximately 70%. A significant reduction in equipment size is also a factor in HyCaps' reduced CAPEX. Avoiding solvent boiling and lower operating temperature results in low energy demand for

**NEXT STEPS**

With three successful pilot demonstrations in different industrial environments, HyCaps has achieved a technology readiness level (TRL) 6. HyCaps is a cost competitive CO<sub>2</sub> capture technology and is ready for scale up and large-scale demonstration. As a next step, CO2CRC is working on a scaled-up design for the equipment and is looking for potential funding and collaboration opportunities to test and showcase HyCaps technology in different industrial applications and environmental conditions.

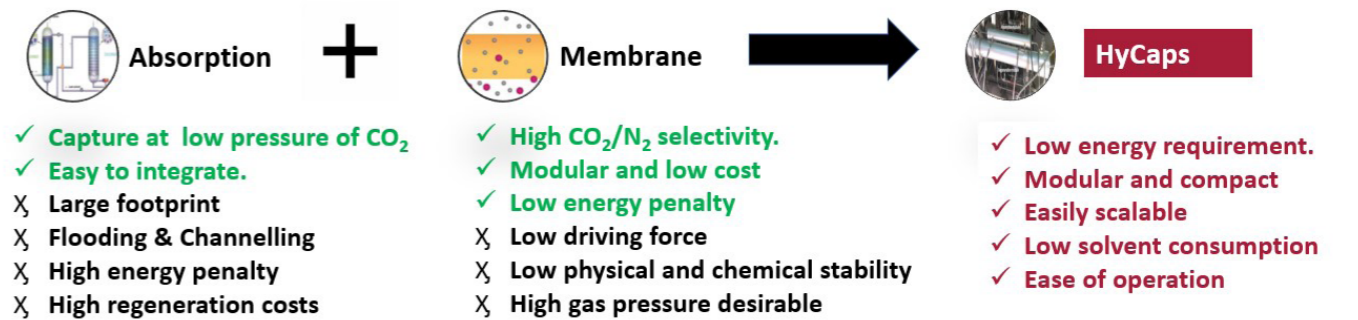

Figure 1

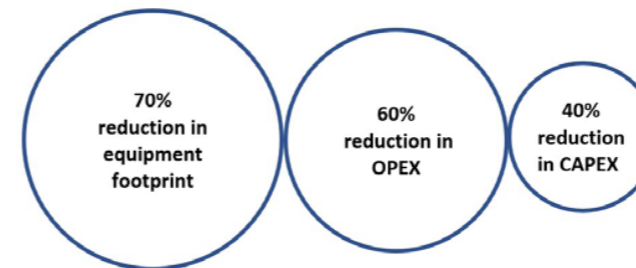

Figure 2





[Ernie.Levinski@elesentct.com](mailto:Ernie.Levinski@elesentct.com)

[www.belco.elesent.com](http://www.belco.elesent.com)

**SUMMARY**

**ELESSENT CLEAN TECHNOLOGIES - PIONEERING GAS CLEANING SOLUTIONS FOR CARBON CAPTURE**

In the pursuit of environmental sustainability, Elesent Clean Technologies stands as a catalyst for change, driving innovation in gas cleaning solutions for carbon capture technologies. Specialising in wet gas cleaning systems, Elesent offers state-of-the-art solutions for pre-cleaning and cooling hot dirty flue gas streams, essential steps preceding carbon capture units (CCUs) aimed at CO<sub>2</sub> reduction. By offering proven scrubbing performance, compact design, and minimal environmental impact, Elesent continues to shape the landscape of emissions reduction, paving the way for a greener, more sustainable future.

**BENEFITS**

- Proven scrubbing performance for severe service hot dirty flue gas applications
- Unique single up-flow design allows plot space requirements
- 160+ licensed units globally
- Applications in refinery fluid catalytic cracking units (FCCUs), boilers, heaters, and fluid cokers
- Installed in various industries including metallurgical plants, oil refining processes, sulfuric acid plants, cement kilns, power plants, and incinerators
- Capable of meeting extremely low particulate matter (PM), SO<sub>x</sub> and NO<sub>x</sub> concentrations
- Robust non-plugging scrubbing designs using open towers
- Energy efficient and optimised for site water usage requirements

**KEY DATA**

TRL	9	Number of Commercial Plants	>160
Target Industries	Refining, Petrochemical, Steel, and Industrial Application		

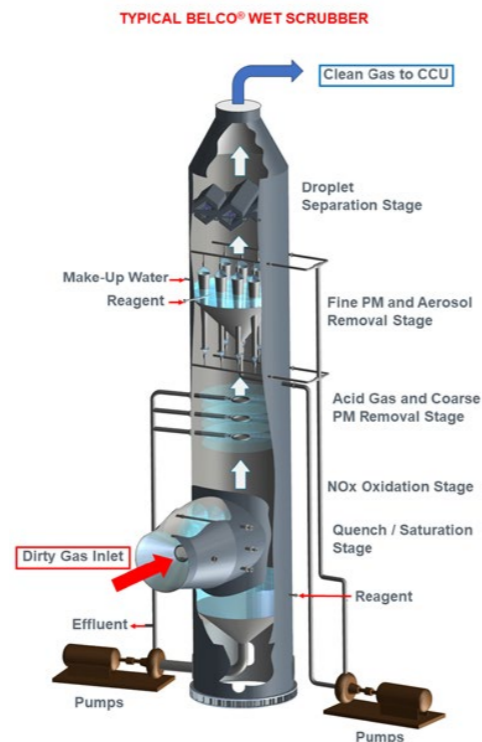

**TECHNOLOGY DESCRIPTION**

**ADVANCED TECHNOLOGIES FOR SEVERE SERVICE APPLICATIONS**

A flagship scrubbing technology at Elesent, BELCO® gas cleaning has earned widespread acclaim for its unparalleled performance in severe service hot dirty flue gas applications. With over 160 licensed units worldwide, BELCO® technology has become indispensable across a spectrum of industries.

**SETTING THE STANDARD**

BELCO® wet scrubbing stands as the gold standard in oil refineries, particularly for cleaning flue gas from fluid catalytic cracking Units (FCCUs), fluid cokers, boilers, and process heaters. Utilising a staged cleaning approach, BELCO® technology efficiently removes particulate matter (PM), sulfur oxides (SO<sub>x</sub>), nitrogen oxides (NO<sub>x</sub>), and aerosols in a single up-flow tower, ensuring optimal system configurations tailored to specific application needs.

With BELCO® scrubbing, hot, dirty flue gas is quenched/saturated flowing into a horizontal inlet in the lower portion of an up-flow tower. When NO<sub>x</sub> control is required, ozone is injected into the scrubber inlet allowing sufficient time to convert oxides of nitrogen to and easily removed nitric acid (HNO<sub>3</sub>). Acid gases and coarse PM are removed with buffered water sprays as gas flows up through the vertical tower. Finer PM is removed with a unique particulate growth and buffered water spray filtration stage. Liquid droplets are removed in the final stage at the top of the tower.

**AIR POLLUTION CONTROL VS. CARBON CAPTURE: UNDERSTANDING THE DIFFERENCE**

While both air pollution control and carbon capture share the common goal of reducing flue gas contaminants, they differ significantly in their requirements, technology complexity, and economic considerations. The flue gas going to a CCU needs to be much cleaner than is typically required to meet regulatory requirements for discharge to the atmosphere.

The requirements for flue gas in air pollution control are less demanding than those for carbon capture, see Table 1 below:

EMISSIONS/ PARAMETERS	TYPICAL STACK EMISSIONS LIMIT	TYPICAL CCU INLET REQUIREMENTS
Particulate matter <sup>1</sup>	<25-100 mg/Nm <sub>3</sub> dry	<25-100 mg/Nm <sub>3</sub> dry
NO <sub>x</sub>	< 10–50 ppmvd (NO + NO <sub>2</sub> as NO <sub>2</sub> )	< 5 ppmvd NO <sub>2</sub> (NO not typically a concern)
SO <sub>3</sub>	N/A	< 1–5 ppmvd
SO <sub>2</sub>	< 25–150 ppmvd	< 1–5 ppmvd
Temperature	N/A	< 40°–45° C

Table 1. Flue Gas Air Pollution Control Stack Emissions Limits vs Carbon Capture Feed Gas Inlet Requirements

For many carbon capture processes, the clean flue gas must also be cooled well below what would be allowed for discharge to the atmosphere. The below list outlines the relative impacts of flue gas contaminants and temperature with carbon capture.

1. Fine particulate and aerosols can lead to fugitive amine stack emissions.
2. NO<sub>x</sub> species may form nitrosamines and nitramines.
3. SO<sub>2</sub> may form heat stable salts which lead to amine degradation.
4. SO<sub>3</sub>/HSO<sub>4</sub> may form sub-micron particles which can lead to amine degradation.
5. Lower feed inlet temperatures are required for optimum CO<sub>2</sub> removal.

In some cases, the process design flowsheet necessitates additional unit operations such as a selective catalytic reduction (SCR) unit upstream for NO<sub>x</sub> control and/or as a wet electrostatic precipitator (WESP) for lowering particle matter. Elesent Clean Technologies has developed an integrated BELCO® system to meet the more stringent demands required of carbon capture processes. This system is an optimised vessel design to minimise plot space requirements and is backed up by process guarantees.

Below is an analysis of the variances between air pollution control and carbon capture, and why carbon capture can be more demanding:

1. Main Goals:
  - Air pollution control standards minimise the emission to the atmosphere of harmful contaminants like particulate matter and acid gases like SO<sub>2</sub> and NO<sub>x</sub>.
  - Carbon capture processes focus on carbon dioxide removal from industrial process gases to reduce climate change impacts. The process of removing CO<sub>2</sub> is an additional layer of complexity given that the flue gas needs to be lower in contaminants that are otherwise emitted into the atmosphere.
2. Regulatory Requirements:
  - Air pollution control standards vary from nation to nation, with further state/provincial variation and site-specific requirements.
  - Carbon capture standards are required by technology licensors to ensure CO<sub>2</sub> capture performance and process guarantees which can be as high as 95% removal efficiency.
3. Technology complexity:
  - Carbon capture processes add a layer of cost to any process comparatively to conventional air pollution control.
  - Carbon capture performance is greatly impacted by flue gas characterisation and its associated contaminant profile.
4. Economic Considerations:
  - The economic feasibility of implementing carbon capture technologies to support greenhouse gas mitigation versus air pollution control requirements plays a significant role in any final investment decision. The cost of carbon dioxide removal technology in addition to cleaning and cooling the flue gas to meet inlet gas stream requirements of these processes is a major factor for project adoption.

# AMS ASSET HEALTH MONITORING



[kristine.crossman@emerson.com](mailto:kristine.crossman@emerson.com)

[www.emerson.com](http://www.emerson.com)

## SUMMARY

Carbon capture, utilisation and storage is a central part of many industry's efforts to reduce emissions and move toward achieving sustainability goals. To ensure a profitable and efficient operation, it will require an end-to-end solution that optimises automation processes. Global technology, software and engineering company Emerson provides this solution with its Boundless Automation™ next-generation architecture, which is designed to break down data silos, liberate information and unleash the power of the intelligent field and industrial software.

As companies wrestle to extract the incremental value from their decarbonisation efforts with technology stacks built around each functional department, islands of fragmented data are difficult to integrate or use.

To address this challenge Emerson's next-generation architecture will empower companies and drive operational excellence by removing silos with intelligent field devices, data-centric software, and flexible automation, delivering operational technology (OT) and information technology (IT) seamlessly across the enterprise.

## BENEFITS

- Compression Units: Once the CO<sub>2</sub> is released from the solvent, it needs to be compressed to a high pressure for transportation and storage. Compression units are essential for this task.
- Transportation Infrastructure: CO<sub>2</sub> is transported either via pipelines or in specialised containers like tankers or trucks to storage sites.
- Vibration condition monitoring in CO<sub>2</sub> compression and pumping station units is crucial to ensure the reliability, efficiency, and safety of the equipment and process:
  - 60 - 90% Downtime Reduction
  - 10 - 20% Availability Improvement
  - 30 - 50% PM Workload Reduction
  - 25 - 50% Calibration Workload Reduction
  - 25 - 50% Scrap and Rework Reduction
  - 15 - 50% Cost of Failure Reduction
  - 5 - 15% Asset Lifecycle Extension
  - 20 - 30% MRO Inventory Reduction

## KEY DATA

TRL	9
-----	---

## TECHNOLOGY DESCRIPTION

### SOLUTION

#### AMS Asset Monitor

The AMS Asset Monitor manages pervasive sensing while providing prediction, protection and process monitoring capabilities. It is designed to mount at the asset, reducing cabling requirements and other installation costs. It accommodates up to 12 CHARMs including Vibration CHARMs as well as DeltaV CHARMs for process inputs. For larger systems, multiple units can be daisy-chained together to extend the asset coverage. This monitor features an internal Logic Studio with multiple pre-programmed application solutions for easy-to-understand analysis and alert reporting. The AMS Asset Monitor can be configured to send overall asset health status and alerts to Emerson's AMS Optics asset performance platform and detailed asset data by OPC UA. Detailed asset information is also available on a user's mobile device or desktop thin client from the monitors internal web-served Asset Studio interface.

- Wired or wireless Ethernet deployment for greater flexibility
- Intuitive browser-based user interface for easy setup and analysis
- Applications already onboard and with preset alert limits for faster setup
- Faster and easier implementation using analysis results presented in plain language.

#### Application (example)

Centrifuge monitoring:

- Motor
  - inboard and outboard bearings
- Centrifuge bowl
  - axial and radial bearings



# INTEGRATED PORTFOLIO OF HARDWARE & SOFTWARE AUTOMATION FOR MIDSTREAM

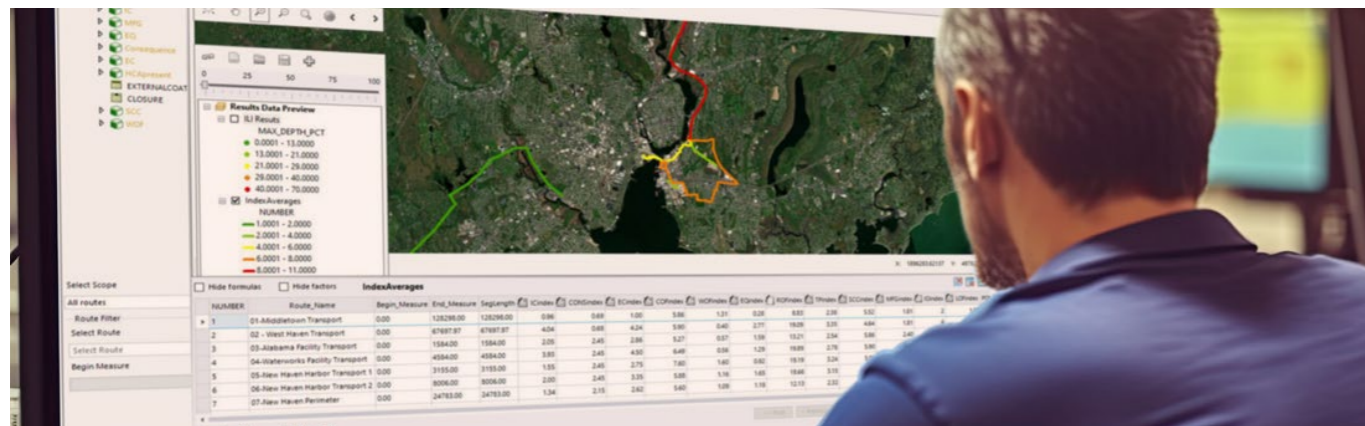

[kristine.crossman@emerson.com](mailto:kristine.crossman@emerson.com)

[www.emerson.com](http://www.emerson.com)

## SUMMARY

As the transition to more sustainable sources of energy continues, fossil fuels will remain a significant component of the world's energy supply for many years to come. To mitigate environmental impacts of sustained fossil fuel use, greenhouse gas (GHG) emission management is imperative.

GHG emissions are generated by several sources across many industries, from methane leaks during gas production and transportation to CO<sub>2</sub> releases from fossil fuel combustion and industrial processes. CO<sub>2</sub> capture has traditionally been used during enhanced oil recovery (EOR). Permanent CO<sub>2</sub> sequestration (CCS) has added a new element to the industry and fueled significant growth and technological advancement.

With many CCS projects, capture and storage may be at two distinct physical sites. Measurement and transportation become key components in the value chain. Emerson offers a comprehensive suite of integrated hardware and software solutions dedicated to transportation and storage for all types of liquid and gas products.

## BENEFITS

- Emerson's next-gen FB Automation Platform of RTUs and flow computers provides the accurate flow calculations and historical auditing and reporting necessary to secure critical carbon credits. All devices support industry standard equations of state calculations for CO<sub>2</sub> (AGA8 2017 Part 2 / GERG 08). The FB3000 RTU additionally supports REFPROP/NIST23.
- There is an increasing need to protect critical infrastructure from cyber-attacks. Emerson's next-gen RTU and flow computers communicate seamlessly with the Monarch SCADA platform using DNP3, a highly secure and authenticated protocol for communications between automation system components.
- Emerson's Pipeline Integrity Management Software offers a prescriptive risk-based model for maintenance, providing a clear understanding of the impacts should a release occur.
- Prevention is not always possible. Emerson's Pipeline Management Software offers a powerful pipeline hydraulic simulation tool aimed at safe and efficient real-time operation. It provides rapid, accurate detection and location of pinhole leaks to large ruptures.
- Emerson's next-gen FB Automation Platform offers a highly flexible, scalable environment for programmable control, custody transfer measurement of a variety of gases and liquids, and secure wide area communications. Solutions include the FB3000 RTU, FB1000 and FB2000 Series Flow Computers, and fit-for-purpose software applications for production and transmission optimisation, networking, and station control.
- The modern Monarch SCADA Platform includes integrated applications and a robust historian, ensuring critical data from remote pipeline operations is transformed into intuitive displays to enhance decision making in busy control room environments.
- Emerson's Pipeline Integrity Management Software provides modern GIS and data integration capabilities, allowing data from multiple sources to be dynamically segmented into a single reference for reliable, accurate risk modeling.
- Emerson's powerful Pipeline Management Software enables real-time monitoring of remote pipeline operations, rapidly transforming data into intuitive displays that facilitate leak detection and localisation, batch tracking, forecasting and more.

## KEY DATA

TRL	9	Applications	3
-----	---	--------------	---

# EMERSON BOUNDLESS AUTOMATION



[kristine.crossman@emerson.com](mailto:kristine.crossman@emerson.com)

[www.emerson.com](http://www.emerson.com)

## SUMMARY

Carbon capture, utilisation and storage is a central part of many industry's efforts to reduce emissions and move toward achieving sustainability goals. To ensure a profitable and efficient operation, it will require an end-to-end solution that optimises automation processes. Global technology, software and engineering company Emerson provides this solution with its Boundless Automation™ next-generation architecture, which is designed to break down data silos, liberate information and unleash the power of the intelligent field and industrial software.

As companies wrestle to extract the incremental value from their decarbonisation efforts with technology stacks built around each functional department, islands of fragmented data are difficult to integrate or use.

To address this challenge Emerson's next-generation architecture will empower companies and drive operational excellence by removing silos with intelligent field devices, data-centric software, and flexible automation, delivering operational technology (OT) and information technology (IT) seamlessly across the enterprise.

## BENEFITS

- Emerson's industrial computing ecosystem includes the flexibility to deploy software across the intelligent field, a software-defined edge, and the cloud.
- This allows carbon capture operations to leverage automation to its fullest potential with secure OT data access, putting data to work across layers to optimise process, reliability, safety, and sustainability simultaneously. New technologies and applications combined with carbon market needs – including “born digital” companies, decentralised operations and the move toward self-optimised plants – have created a new automation paradigm where a unified software environment streams data across the enterprise effortlessly, when and where it's needed.
- Emerson's software-defined automation architecture breaks down hierarchical networks, securely democratising and contextualising data enabling your business needs from artificial intelligence engines to providing a trail of auditable data for carbon monetisation. This technology mindset provides a foundation from the field to the boardroom for the future of data and automation in complex, disparate CCUS operations .

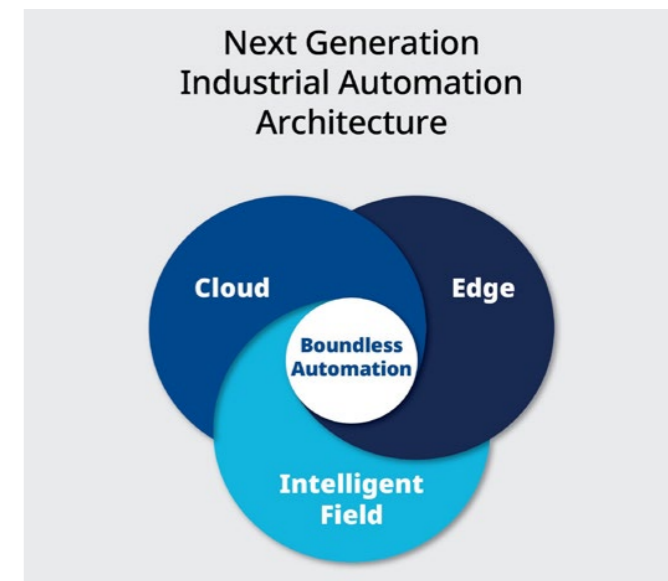

## KEY DATA

TRL	9	Applications	20
-----	---	--------------	----



[nick.namphengsone@emerson.com](mailto:nick.namphengsone@emerson.com)

[www.emerson.com](http://www.emerson.com)

**SUMMARY**

Retrofitting an existing facility with one of the commercially available capture technologies poses many challenges from both a capital expenditure (CAPEX) and operational expenditure (OPEX) perspective. The automation portion makes up <10% of the overall CAPEX, but choosing the right automation platform has severe impacts on the overall project's total install cost, schedule, and risk management. Emerson's DeltaV platform offers valuable technology enablers aimed at addressing these challenges. DeltaV is designed to be a fit for purpose platform that can accommodate small systems, such as equipment skids, to large scale >30,000 IO systems.

The DeltaV automation platform provides the infrastructure for users to develop a "Born Digital" automation layer that is easily integrated into a centralised data-management system. Adding carbon capture reduces efficiency of the production facility and increases power and water usage. Getting contextualised data to advanced applications is key to performing first-principles and data-driven analysis for energy optimisation.

**BENEFITS**

- Electronic Marshalling and Standard Smart Junction Boxes enables faster deployment of modular units that are de-coupled from one another.
- DeltaV Edge solution delivers a one-way encrypted outbound dataflow that can serve data to an Energy Management Information System to drive reduction in total site energy usage.
- For schedule-driven projects, Smart Commissioning uses embedded features within DeltaV to reduce commissioning time of each device by up to 90%.
- Native integration with AMS Device Manager allows for users to manage all your field devices using a single, integrated application and predict necessary maintenance activities instead of reacting to problems.
- Built on a digital ethernet and fiber backbone, centralised remote operations is possible for disparate remote assets.
- For customers needing a small system with a lower initial investment cost, DeltaV Flex is a subscription package that provides a fully functional DeltaV system with only the features you need.

**PROVEN RESULTS**

- Since the release of DeltaV Electronic Marshalling CHARMS IO technology in 2011, there has been over 3 million CHARMS deployed and running with a cumulative 200+ billion hours of operating experience.
- A leading cryogenic process technology company is utilising DeltaV for their R&D and pilot system that can be easily scaled up to a full production facility.
- In 2024, one of the largest CCU facilities was put into operation utilising DeltaV technology and is expected to capture 180,000 metric tons of CO<sub>2</sub>.
- A cement facility in the Middle East is utilising DeltaV to capture 800,000 tonnes of CO<sub>2</sub> per year from the flue gas and injecting the CO<sub>2</sub> for enhanced oil recovery (EOR).
- DeltaV has been selected to automate a new greenfield blue hydrogen facility in Texas that is expected to sequester 1.7 million metric tons of CO<sub>2</sub> emissions each year.

**KEY DATA**

TRL	9	Applications	15
-----	---	--------------	----

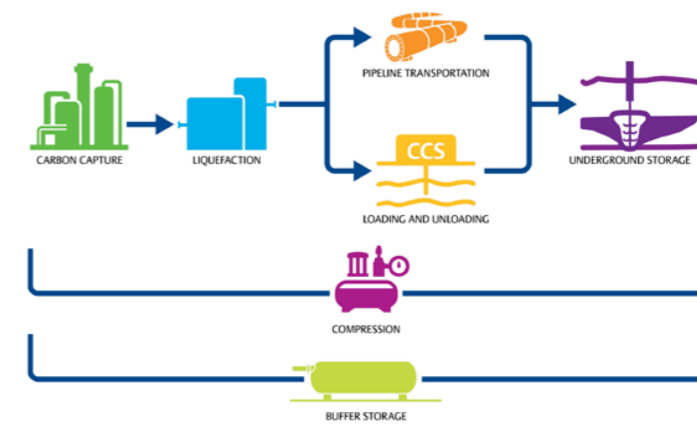

[kristine.crossman@emerson.com](mailto:kristine.crossman@emerson.com)

[www.emerson.com](http://www.emerson.com)

**SUMMARY**

As carbon capture and storage (CCS) gains traction as a means of reducing emissions from large point sources, such as power plants and fuel processing facilities, it is critical for process manufacturers to specify and install equipment that facilitates efficient CCS, along with safe and reliable everyday operations. Valves are required in all stages of the CCS value chain, including post-combustion CO<sub>2</sub> capture, pre-combustion capture, direct air capture, transportation, utilisation, and sequestration.

Pressure safety valves (PSVs) are a common area for operational and emissions inefficiencies. Most conventional PSVs are oversized, releasing too much gas during over-pressure events, which translates to excess releases of CO<sub>2</sub> into the atmosphere. Additionally, leaking valve seats often limit the working pressure of compressors, reducing process efficiency.

Compressor surge is another source of regular process inefficiencies, as well as potential equipment damage. Because surges occur rapidly, traditional control valves often do not react quickly enough.

**BENEFITS**

- Emerson provides modern valve and accessory solutions, along with recommendations for appropriate selection in each application.
- Anderson Greenwood type 400/800 true modulating PSVs provide overpressure protection, while minimising discharging to the atmosphere. These valves also facilitate maximum compressor efficiency by providing seat tightness up to 98% of setpoint. Additionally, optional spike snubbers dampen the impact of pressure spikes, helping process units operate closer to set pressure for more efficient operation and reduced emissions.
- To protect against compressor surge, Vanessa V30K triple offset valves provide reliable bypass solutions, speeding response time and improving protective safety system operation. Fisher Optimised Anti-Surge Control Valves with FIELDVUE positioners ensure safe operations of critical compressor assets.
- Finally, Shafer Emissions Controlled Actuation Technology (ECAT) provides a zero-emission option for pipeline valve actuation. This innovative technology uses accumulators to re-inject pipeline gas that is used to drive the actuator and valve with zero emissions.



**KEY DATA**

TRL	9	Applications	20
-----	---	--------------	----



ENTROPY

# INTEGRATED CARBON CAPTURE (iCCS™)



[www.entropyinc.com](http://www.entropyinc.com)

## SUMMARY

Entropy Inc. is a client-focused global full-service carbon capture and storage (CCS) developer, specialising in innovative solutions to significantly reduce CO<sub>2</sub> emissions from pre and post-combustion sources at third-party sites. Additionally, Entropy offers subsurface expertise in CO<sub>2</sub> sequestration, as demonstrated by decades of experience safely storing acid gas and CO<sub>2</sub> at the Glacier facility. Modular and integrated CCS technology, paired with the proprietary solvent Entropy23™, sets a new standard in efficiency and cost-effectiveness for both retrofit and new CCS installations. Entropy's strategic partnership with the Clean Energy & Technology Research Institute (CETRI) at the University of Regina comprises a team of internationally renowned experts who develop and test advanced CCS systems. Entropy entered a strategic investment agreement with Brookfield Renewable for \$300 million in addition to a more recent investment agreement with the Canada Growth Fund (CGF) for \$200 million, including a 15-year, \$1 billion fixed-price Carbon Credit Offtake (CCO) agreement for up to 1 million tonnes per annum (tpa) to invest development of CCS facilities at third party emissions sites. (Visit the Entropy website for additional information, [www.entropyinc.com](http://www.entropyinc.com)).

## BENEFITS

- **Proven:** Operating since July 2022, Entropy operates and owns the world's first and only commercial natural gas post-combustion CCS facility, establishing itself as a leader in cost-efficient, reliable technology.
- **Energy Efficient:** The use of waste heat recovery, heat integration, and a high-performance solvent significantly reduces the energy required for carbon capture, achieving high CO<sub>2</sub> recovery rates with lower electrical energy loads.
- **Advanced Solvent:** The high-performance solvent Entropy23™ offers superior efficiency in CO<sub>2</sub> capture, resulting in lower energy and solvent requirements, enhancing the economic feasibility of CCS projects.
- **Scalable:** Entropy's iCCS™ technology is designed for scalability, allowing for reduced capital costs, flexible maintenance, and efficient installation across various industrial applications and scales from <100 ktpa to >1Mtpa.

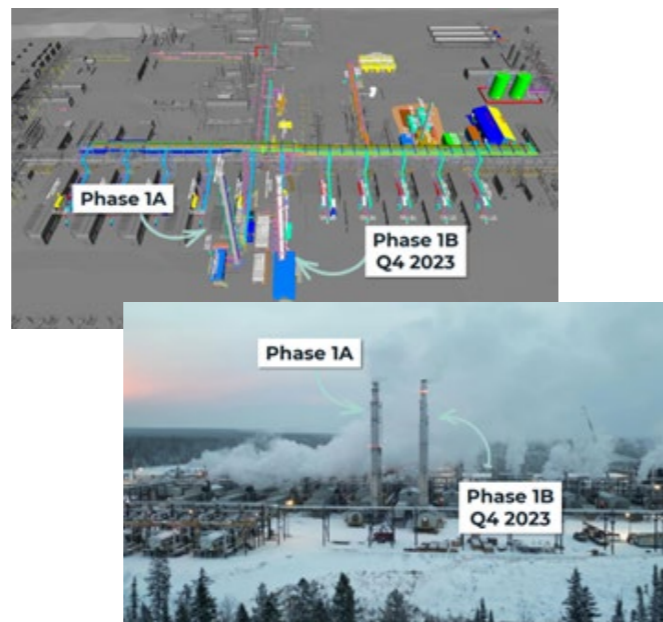

## KEY DATA

TRL	9	Capture Rate Range (tpd)	40 - 3,000+	Modular (Y/N)	Yes <sup>2</sup>
Source CO <sub>2</sub> Concentration	3 - 20%+	Energy Consumption (GJ/tCO <sub>2</sub> )	2.4 <sup>1</sup>	Capture Efficiency (%)	90 - 98%
Number of Commercial Plants	~	Number of Pilot Plants	~		
Target Industries	Natural Gas, Thermal Oil, Ethanol, Methanol, Steel Production, Power Generation				

## TECHNOLOGY DESCRIPTION

Entropy's CCS system, utilising advanced solvent-based technology, is currently operational at the Glacier Gas Plant near Grand Prairie, Alberta, Canada, abating CO<sub>2</sub> from the exhaust of two natural gas reciprocating compressor engines. This initiative is part of a larger project to sequester CO<sub>2</sub> from all 11 compressor engines on site, equating to over 41,000 HP of engines collectively. In addition, Entropy has initiated preliminary front-end engineering and design (pre-FEED) and FEED work on several large-scale projects across a broad range of emission sources in both Canada and the United States.

Entropy has focused its carbon capture technology into three standardised designs to optimise post-combustion emissions capture across various industrial applications. The iCCS Thermal™ design targets boilers and steam generators, seamlessly integrating with these systems to curb emissions. For industrial engines, including compressors, the iCCS Recip™ design has been successfully deployed and is currently operating at the Glacier Gas Plant. Lastly, the iCCS Turbine™ design captures emissions from gas-fired turbines with low CO<sub>2</sub> concentrations, applicable worldwide for generating low emissions power generation and compression from turbines.

## GLACIER OPERATIONS

### Phase 1A - MCCS™

Glacier Phase 1A, the first commercial deployment of Entropy's MCCS™ technology, abates and stores CO<sub>2</sub> emissions from a 5,000 HP compressor engine. The facility employs heat recovery exchangers, an exhaust gas blower, an absorber tower, solvent and water pumps, a solvent regeneration skid, and compression and dehydration units. By integrating waste heat recovery into the CCS design, the system meets all the heat requirements for amine regeneration, consistently maintaining CO<sub>2</sub> recovery rates between 90% and 98%. The system features a modular design, enabling cost-effective scalability in terms of installation, maintenance, and capital expenditure. The CCS equipment at Glacier is specifically designed for emissions from CAT3616 compressors, 16-cylinder reciprocating engines fuelled by natural gas, which are commonly used in natural gas transportation across North America. This phase sets a new performance benchmark for carbon capture technology, demonstrating its potential in reducing greenhouse gas emissions from existing industrial facilities and contributing to global decarbonisation efforts.

### Phase 1B - iCCS™

The Glacier 1B project represents a milestone in the commercial application of Entropy's CCS technology. As an extension of Phase 1, 1B incorporates Entropy's integrated carbon capture solution (iCCS™) designed to capture carbon emissions from an additional 3616 unit. This phase leverages a newly installed 5,000 HP gas-fired compressor package equipped with built-in CCS technology, reducing the total installed cost and energy intensity compared to retrofit installations. Successfully installed in the fourth quarter of 2023, Phase 1B is now fully operational, showcasing substantial advancements in design and cost efficiency.

### Glacier Phase 2 - iCCS Turbine™ clean power:

Entropy has reached final investment decision (FID) for Glacier Phase 2, which is planned to come onstream in Q2 of 2026. This phase will capture the emissions from the remaining nine natural gas reciprocating engines at Glacier facility, targeting over 90% efficiency. Additionally, Entropy will install a 15MW gas-fired turbine to provide clean, reliable power and heat for both the Glacier gas plant and Entropy CCS equipment. Entropy will install one iCCS Turbine™ module on the gas turbine, capturing 90% of the CO<sub>2</sub> exhaust emissions (3.5 mol% CO<sub>2</sub> concentration). Total CO<sub>2</sub> capture capacity for Phase 2 is 160,000 TPA, which will be available for permanent geological sequestration in addition to the existing Phase 1 capacity of 32,000 TPA. This project will be contractually underpinned by the 15-year CCO agreement with CGF, as well as a 15-year Power Purchase Agreement (PPA) with Advantage Energy Ltd (Glacier Gas Plant operator). Glacier Phase 2 integrates multiple industry-first innovations developed since 2022 while operating Glacier Phase 1 including design refinements, standardized procedures, enhanced operational strategies identified using EntropyIQ™ data analysis, solvent enhancements, and customized original equipment facilitated by manufacturers.

## ENTROPYIQ™

EntropyIQ™ represents the digital innovation arm of Entropy's CCS technology and enables precise, real-time monitoring and optimisation of carbon capture processes. This digital data gathering and processing engine plays a crucial role in achieving operational efficiencies, as evidenced by the optimisation protocols conducted at the Glacier CCS project. EntropyIQ™ ensures optimal capture rates and energy utilisation, facilitating the continuous improvement of CCS operations. In addition, EntropyIQ™ is instrumental in the monitoring, measurement, and verification of data for third-party verification, reporting, and compliance purposes. This capability is essential for meeting regulatory standards, securing carbon credits, and providing transparency to stakeholders.

## FUTURE PROJECTS

Entropy is focused on deploying its innovation and solutions at third-party industrial sites. Entropy brings both technical carbon capture solutions and geological sequestration expertise while de-risking projects with offtake agreements and its own capital. Suitable project attributes include an established carbon policy and price framework as well as feasible storage regulation and geology. Entropy is currently engaged with multiple clients across various industries including production of natural gas, thermal oil, ethanol, methanol, steel and clean power throughout North America.

<sup>1</sup> 2.4 GJ/t gross regeneration duty, all of which is provided via waste heat integration in active projects to date.

<sup>2</sup> Modular construction scalable for applications 1Mtpa +



[sunil.vyas@fluor.com](mailto:sunil.vyas@fluor.com)

[www.fluor.com](http://www.fluor.com)

**SUMMARY**

Fluor's Econamine FG Plus (EFG+) technology is an industry recognised, proven, and cost-effective process to remove carbon dioxide (CO<sub>2</sub>) from low-pressure and post-combustion gas streams. Over the last four decades, 30 EFG+ units have been built worldwide to capture CO<sub>2</sub> from gas streams derived from a variety of fuels such as natural gas, coal, light fuel oil, heavy fuel oil, and LPG. The solvent formulation is specially designed to recover CO<sub>2</sub> from low-pressure gas streams. The EFG+ solvent has been proven to be successful on flue gases containing as low as 3.5 vol percent (dry) CO<sub>2</sub>.

**BENEFITS**

- Significant improvements were made over the past 20 years to improve energy consumption (reduced by 36 percent), reduce solvent degradation (reduced by 3 to 6 times), and improve the environmental signature (solvent, ammonia, and VOC emissions are all drastically reduced).
- The main ingredients in the EFG+ solvent is readily available, inexpensive, and are produced by multiple qualified solvent manufacturers. This provides the licensee with the ability to source solvent on a competitive basis, rather than being fixed to a 'single source' arrangement.
- Our Advanced Solvent Maintenance System, the result of significant development work and successfully proven in practice, is key to maintaining trouble-free operation in the presence of oxygen, improving both solvent hygiene and environmental signature of the process, and significantly reducing solvent losses compared to more conventional thermal reclaiming systems.
- The proprietary absorber water wash system minimises slip of solvent and other components into the treated flue gas, resulting in low atmospheric emissions.

**KEY PROJECTS**

- Northeast Energy Associates (Bellingham, Massachusetts): The Bellingham EFG+ plant had continuous commercial operation from 1991 to 2005 on a flue gas flow from a NGCC power plant.
- E.ON Demonstration Plant (Germany) - Capture Pilot plant in Wilhelmshaven, Germany
- Chevron Kern River (California) - Capture plant at Chevron's Eastridge Cogeneration Facility in Kern County.
- Confidential Power Plant - FEED for >1,000 TPD plant
- Federated Co-Operatives Refinery Complex (Canada)
- Federated Co-Operatives Renewable Diesel Complex (Canada)

**KEY DATA**

TRL	9	Capture Rate Range (tpd)	Up to 20,000	Modular (Y/N)	~
Source CO <sub>2</sub> Purity Range	As low as 3%	Energy Consumption (GJ/tCO <sub>2</sub> )	~	Capture Efficiency (%)	95%
Number of Commercial Plants	30	Number of Pilot Plants	~		
Target Industries	Power Generation, Cement, Steel, Glass, Pulp & Paper, Reformers in Chemical/Oil & Gas facilities, Waste to Power				

**TECHNOLOGY DESCRIPTION**

**PROVIDING PROFESSIONAL AND TECHNICAL SERVICES**

Fluor is building a better world by applying world-class expertise to solve its clients' greatest challenges.

Fluor's 30,000 employees provide professional and technical solutions that deliver safe, well-executed, capital-efficient projects to clients around the world. We take pride in our long history of successful execution of thousands of projects and our extensive successful track record in the execution of carbon capture projects.

Fluor provides engineering, procurement, and construction (EPC) services to carbon capture projects including CO<sub>2</sub> compression and transportation. Additionally, Fluor has the unique ability to be the technology licensor and EPC for any carbon capture project using EFG+. Our carbon capture project experts focus on the delivery of innovative, reliable, and cost-efficient project solutions built on more than 110 years of EPC and maintenance experience and 30 years of experience in carbon capture.

**PROJECT EXPERIENCE**

Northeast Energy Associates (Bellingham, Massachusetts): The Bellingham EFG+ plant had continuous commercial operation from 1991 to 2005 (more than 120,000 hours of operation over 14 years). The carbon capture plant's profile is as follows:

- Capacity: 330 tpd CO<sub>2</sub> captured
- 40 MW flue gas flow from NGCC power plant
- CO<sub>2</sub> Concentration: 3.5 percent v/v
- O<sub>2</sub> Concentration: 13-14 percent v/v
- Product Usage: food grade CO<sub>2</sub>
- On Stream Factor: 98.5 percent in 2004
- 100 percent air cooled

E.ON Demonstration Plant (Germany). Fluor and E.ON Kraftwerke (E.ON) were partners in developing a slipstream carbon capture pilot plant in Wilhelmshaven, Germany. The construction phase included demonstration of new

materials and techniques for erection of process columns, installation of several energy saving process systems, installation of extensive instrumentation suitable for testing and R&D and incorporation of remote monitoring capability.

**Chevron Kern River (California).** Chevron New Energies has signed a license agreement with Fluor to use its EFG+ carbon capture technology to reduce CO<sub>2</sub> emissions at Chevron's Eastridge Cogeneration facility in Kern County, California. Fluor's carbon capture solution is expected to reduce the Eastridge facility's carbon emissions by approximately 95 percent. Fluor is developing a process design package, supplying proprietary equipment, and providing technical support services throughout various stages of the project.

**Federated Co-Operatives Refinery Complex.** Fluor is the selected carbon capture licensor and is currently producing licensor design packages for two units designed to capture CO<sub>2</sub> from flue gases produced by existing steam methane reformers and new auxiliary boilers.

**Federated Co-Operatives Renewable Diesel Complex (Canada).** Fluor has completed FEED for a greenfield renewable diesel facility that included post-combustion carbon capture from flue gases produced by a steam methane reformer, auxiliary boiler, and a fired heater.

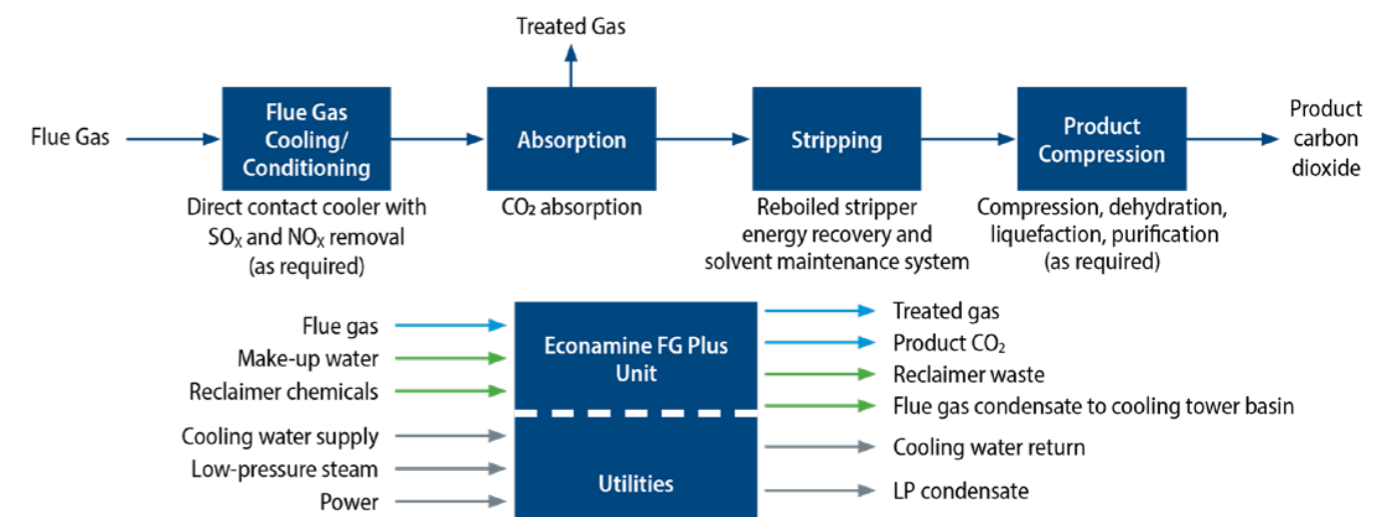

Figure: A typical EFG+ block flow diagram of the process is shown below.



info@fce.com

www.fuelcellenergy.com

SUMMARY

FuelCell Energy, Inc is a provider of power generation and hydrogen solutions based on high temperature electrochemical technologies. One of those platforms, the molten carbonate fuel cell, offers a unique approach to capturing carbon dioxide from power generation or thermal sources while simultaneously producing power. Carbonate fuel cells generate power in electrochemical reactions that are supported by an electrolyte layer in which carbonate ions serve as the ion bridge that completes the electrical circuit. A side effect of this basic characteristic of the technology is that carbon dioxide introduced at the air electrode is transferred through the electrolyte layer to the fuel electrode, where it is more highly concentrated and easy to remove. This means that carbonate electrochemical cell stacks can be used as a carbon purification membrane – transferring CO<sub>2</sub> from a dilute oxidant stream to a more concentrated fuel exhaust stream.

BENEFITS

- **Co-production of power during carbon capture**, which provides an additional revenue stream to offset the cost of carbon capture.
- **Co-production of clean water** from the fuel cell reaction, which can be used to offset water requirements of the coal or gas system that CO<sub>2</sub> is being captured from.
- **Optional co-production of hydrogen** exporting residual hydrogen from fuel cell reformat.
- **NO<sub>x</sub> destruction.** Reactions occurring on the carbonate electrode surfaces destroy NO<sub>x</sub>, so processing flue gas in a carbonate fuel cell system will destroy up to 70% of the NO<sub>x</sub> in the flue gas, reducing or eliminating capital and operating costs for NO<sub>x</sub> destruction equipment.
- **Modular,** can be deployed incrementally to manage capital outlay and changes in the cost of power, and to address a wide scale of application sizes.

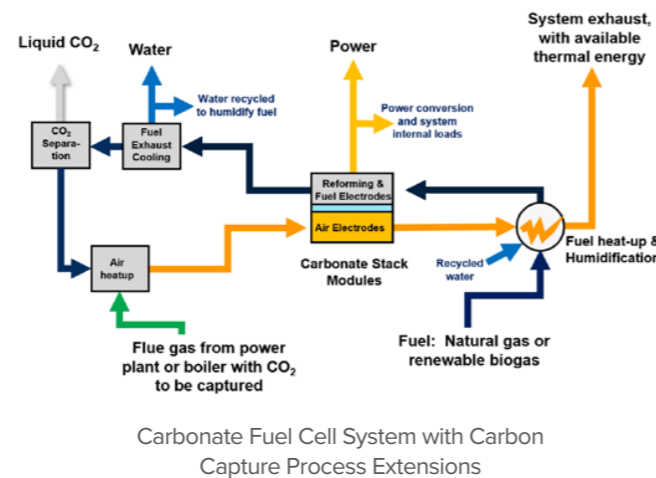

KEY DATA

TRL	9	Capture Rate Range (tpd)	>30	Modular (Y/N)	Yes
Source CO <sub>2</sub> Purity Range	>6	Energy Consumption (GJ/tCO <sub>2</sub> )	N/A	Capture Efficiency (%)	70 - 95%
Number of Commercial Plants	N/A	Number of Pilot Plants	1		
Target Industries	Capture from industrial and power generation point sources with power and (optional) hydrogen co-production				

TECHNOLOGY DESCRIPTION

Fuel cells are electrochemical devices comprised of negative and positive electrodes that are fed by fuel and air streams to produce power. An electrolyte layer between the electrodes supports ion transfer from positive to negative electrodes to maintain charge balance as electrons are produced and consumed in the power circuit. The fuel is often hydrogen, but in the case of carbonate fuel cells methane (from natural gas or biogas) is used and converted to hydrogen inside the fuel cell. Carbonate ions serve as the ion bridge that completes the electrical circuit. During power generation the carbonate ion transfer results in CO<sub>2</sub> being produced in the fuel electrodes and consumed in the air electrodes. This CO<sub>2</sub> flux is what is used for carbon capture. The cell and stack structure and electrochemical reactions are illustrated below, which show the components which comprise a stack module that produces a net output of 1.4 MW. Multiple modules are configured into systems to provide the desired output level.

The fuel electrodes in a carbonate stack also support the reforming of methane to hydrogen, which is then consumed by the fuel cell reaction to make power. The reforming reaction will produce one molecule of carbon dioxide for each molecule of methane fuel. The fuel electrode reaction produces additional carbon dioxide (four more molecules for each methane input), which is recycled back to the air electrodes, where the extra four molecules are consumed. The recycle system is part of the mechanical balance of plant of a carbonate fuel cell power plant. Extracting carbon dioxide from this recycle stream and replacing it with external carbon dioxide from a flue gas is the key to the carbonate fuel cell carbon capture approach.

Using carbonate fuel cell for carbon capture involves adding process equipment to the power plant mechanical balance of plant. In a standard carbonate power plant, CO<sub>2</sub> produced at the anode is recycled back to the cathode to provide the CO<sub>2</sub> needed by the air electrodes. If the concentrated CO<sub>2</sub> in the anode exhaust stream is extracted from the system and not recycled back to the cathode, an external source of CO<sub>2</sub> can support the cathode reaction. This external source can be the flue gas from an industrial or power generation source. The dilute CO<sub>2</sub> in the external

flue gas will be reacted at the fuel cell cathodes and transferred to the anode stream, from which it can be easily separated for sequestration or utilisation. An illustration of the standard process components and carbon capture extensions is shown in the system diagram above. The depleted fuel stream leaving each module contains the CO<sub>2</sub> to be extracted along with residual hydrogen left over from the power generation reaction. This hydrogen can be recycled back to the system or extracted as an additional value stream from the process. This type of hydrogen co-production is in commercial operation in FCE's Tri-gen platform, which co-produces 2.3 MW power, 1270 kg/day hydrogen, and 1400 gallons/day of water.

The size of the carbonate power plant required to capture CO<sub>2</sub> from a specific source depends on the size of the source and the CO<sub>2</sub> emission rate. A 1.4 MW carbonate module during normal power operation is transferring about 40 tons of CO<sub>2</sub> per day from the cathode to anode streams in the stack modules. In carbon capture mode, this module could capture and purify up to 30 tons per day of external CO<sub>2</sub> in addition to the CO<sub>2</sub> from the power plant fuel input. The modular nature of the system allows a wide range of system applications. Power plants rated at single to tens of MW output are a good fit for industrial applications, such as capture from boilers, with 10's to 100's of tons/day capture. This size system is attractive in CO<sub>2</sub> utilisation applications with on-site power, heat, and CO<sub>2</sub> production.

For larger sequestration applications, FCE has been engaged in a joint development program with ExxonMobil to improve the carbon capture performance of the cells and to develop a new stack module design targeted at larger scale systems. The first prototypes of this new design module are being fabricated for testing at FCE's test facility. Two of the new modules will be used in a demonstration built by ExxonMobil affiliate Esso Nederland BV at their Rotterdam Manufacturing Complex in the Netherlands. The project is Co-funded by the European Union under the Emissions Trading System Innovation Fund and by the Netherlands Enterprise Agency. The project is scheduled to begin operation in 2026.

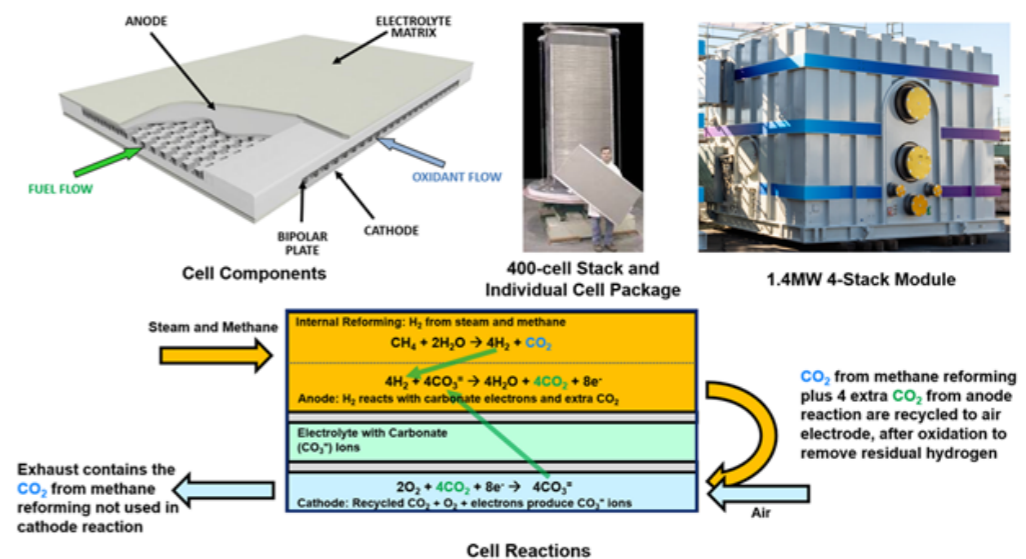

# Honeywell AMINE GUARD™ PROCESSES



[Nathan.lozanoski@honeywell.com](mailto:Nathan.lozanoski@honeywell.com)

[www.honeywell.com](http://www.honeywell.com)

## SUMMARY

Honeywell UOP Amine Guard™ process technologies combine high-performance solvents with Honeywell UOP engineering expertise for acid gas removal applications. The thermal or flash regenerated solvent process removes CO<sub>2</sub>, H<sub>2</sub>S, COS, and other sulfur components. Hydrocarbon, H<sub>2</sub>, and CO losses are minimal in the Amine Guard processes due to their low solubility in the solvent. There are energy efficient process optimisations available, such as a flash-only solvent regeneration flow scheme for bulk CO<sub>2</sub> removal.

The Honeywell UOP Amine Guard FS process technology was introduced over 20 years ago and to date more than 400 units have been put into commercial service. Existing operating LNG plants in the Middle East demonstrating excellent performance of UOP licensed process technologies & UOP supplied products (solvents / adsorbents / equipment).

### AMINE GUARD™ PROCESSES

- **Application:** Designed for applications of high-volume gases where removal of CO<sub>2</sub> and H<sub>2</sub>S are present such as natural gas, syngas, gasification, blast furnace gases, and more removing and purifying gases to meet specifications as appropriate.
- **Description:** Acid or flue gases are scrubbed out in an absorber column using UCARSOL solvent for the application. The now rich solvent flows from the bottom of the absorber through heat exchange process and is stripped out in a stripping tower, where the lean solvent is then recirculated to absorber for additional CO<sub>2</sub> absorption. Waste heat can commonly be utilised to provide the stripping steam.
- **Technology Maturity:** Amine Guard and Amine Guard Formulated Solvent (FS) is considered TRL 9 and has been in commercial operation since the 1990s with over 400 units worldwide.
- **Advantages:** Selecting the optimum UCARSOL solvent for the situation can optimise regeneration energy requirements. Low energy two stage configurations can also be implemented where appropriate.

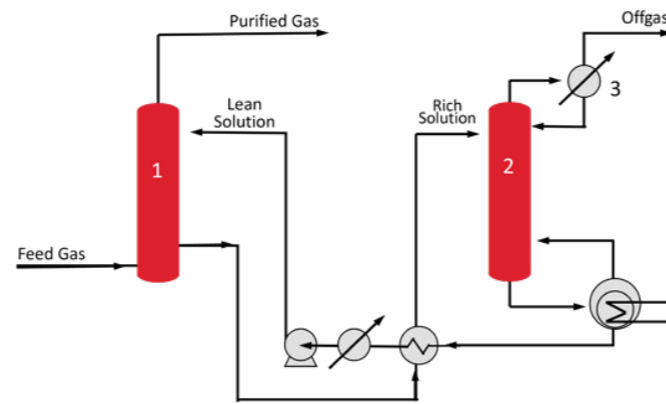

## KEY DATA

TRL	9	Capture Rate Range (tpd)	~	Modular (Y/N)	No
Source CO <sub>2</sub> Purity Range	~	Energy Consumption (GJ/tCO <sub>2</sub> )	~	Capture Efficiency (%)	~
Number of Commercial Plants	400+	Number of Pilot Plants	~		
Target Industries	Biomass Gasification, Coal Gasification, Natural Gas, Ammonia Syngas, Hydrogen Syngas, Synthetic Natural Gas, GTL Front End Treatment				

# Honeywell BENFIELD™



[Nathan.lozanoski@honeywell.com](mailto:Nathan.lozanoski@honeywell.com)

[www.honeywell.com](http://www.honeywell.com)

## SUMMARY

Originally developed at the US Bureau of Mines in the early 1950s, the hot potassium carbonate (HPC) process has been modified and optimised by Benson and Field and, subsequently, Honeywell UOP. The UOP Benfield™ Process is a thermally regenerated cyclical solvent process using an activated, inhibited hot potassium carbonate solution to remove CO<sub>2</sub>, H<sub>2</sub>S and other acid gas components. More than 700 Benfield™ units have been put into commercial service. In addition to its wide use in ammonia and hydrogen production, the Benfield™ process has been applied in more than 50 natural gas plants and in direct iron ore reduction plants.

Our support spans the project life cycle from conceptual and feasibility studies, through Front End Engineering Design (FEED), commissioning startup and services during the operational life. Honeywell can deliver technologies through basic engineering packages as well as modular solutions to meet your needs. Honeywell provides extensive warranty and performance guarantees.

### BENFIELD™ PROCESSES

- **Application:** Designed for applications of high volume gases where CO<sub>2</sub> and H<sub>2</sub>S are present, such as natural gas, ammonia syngas, hydrogen syngas, gasification, flue gases, partial oxidation, & more removing and purifying gases to meet specifications as appropriate.
- **Description:** Flue or acid gases are pressurised and scrubbed out in an absorber column using potassium carbonate solution (with Benfield™ additives to improve performance and prevent corrosion) solvent. The now rich solvent is regenerated by reducing its pressure and stripping in a tower. The lean solvent is then recirculated to absorber for additional CO<sub>2</sub> absorption. Waste heat can commonly be utilised to provide the stripping steam.
- **Technology Maturity:** Benfield™ is considered TRL 9 and has been in commercial operation since the 1960s with over 700 units worldwide.
- **Advantages:** Selecting the optimum UCARSOL solvent for the situation can optimise regeneration energy requirements. Low energy two stage configurations can also be implemented where appropriate.

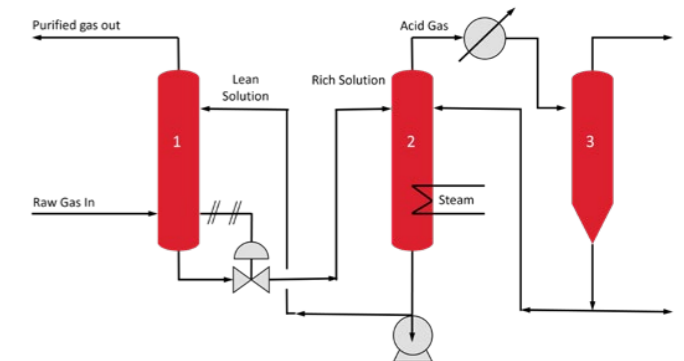

## KEY DATA

TRL	9	Capture Rate Range (tpd)	~	Modular (Y/N)	~
Source CO <sub>2</sub> Purity Range	~	Energy Consumption (GJ/tCO <sub>2</sub> )	~	Capture Efficiency (%)	~
Number of Commercial Plants	700	Number of Pilot Plants	~		
Target Industries	Power, Steel, Cement, Refining & Petrochemical, Waste to Energy, BECCS, Pulp & Paper, Gas Processing, & Industrial Flue Gases				



# Honeywell ADVANCED SOLVENT CARBON CAPTURE (ASCC)



[Nathan.lozanoski@honeywell.com](mailto:Nathan.lozanoski@honeywell.com)

[www.honeywell.com](http://www.honeywell.com)

## SUMMARY

For flue gas applications, Honeywell UOP offers their Advanced Solvent Carbon Capture (ASCC) technology which is a second generation (2G) amine scrubbing process. ASCC can efficiently capture >95% of produced CO<sub>2</sub> from a variety of flue gas applications, including the flue gas output of coal-fired power plants. Honeywell (ASCC) has important differentiators that enable improved operational efficiency and reduced capital expenditures for CO<sub>2</sub> capture in flue gas applications. ASCC is backed by 20+ years of ongoing development and testing. ASCC has demonstrated 9,500+ hours of successful testing at the National Carbon Capture Center on flue gas range 2-15%.

Honeywell has designed 1,200+ solvent-based units for gas processing applications. Our support spans the project life cycle from conceptual and feasibility studies, through Front End Engineering Design (FEED), commissioning startup and services during the operational life. Honeywell can deliver technologies through basic engineering packages as well as modular solutions to meet your needs. Honeywell provides extensive warranty and performance guarantees.

### ADVANCED SOLVENT CARBON CAPTURE (ASCC)

- Application:** Designed for applications of low concentration high volume gases such as power generation, cement, steel, industrial (boilers & fired heaters), pulp and paper, fluid catalytic crackers & more.
- Description:** Flue gases are scrubbed out in an absorber column using a proprietary solvent (AZ-108). The rich solvent flows through a patented series of heat exchange process and is stripped out in a high pressure stripper, where the lean solvent is recirculated to the absorber for additional CO<sub>2</sub> absorption.
- Technology Maturity:** ASCC is widely considered TRL 7 and has been in development and scale up for over 20 years. Multiple FEED studies are ongoing at this time.
- Advantages:** ASCC can enable 30% lower capital expenditures on absorber(s), low energy of regeneration requirements (2.1 GJ/MT of CO<sub>2</sub>), stripping at high pressure (6-8 barg) eliminates compression requirements, saving capital and operation expenditures.

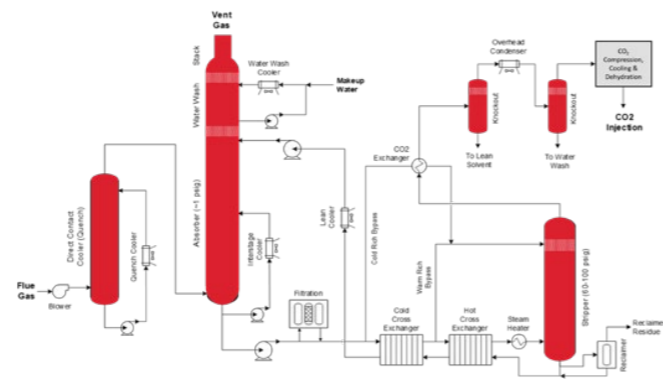

## KEY DATA

TRL	7	Capture Rate Range (tpd)	~	Modular (Y/N)	Yes
Source CO <sub>2</sub> Purity Range	2 – 15%	Energy Consumption (GJ/tCO <sub>2</sub> )	1.8 - 2.4	Capture Efficiency (%)	~
Number of Commercial Plants	~	Number of Pilot Plants	3		~
Target Industries	Power, Steel, Cement, Refining & Petrochemical, Waste to Energy, BECCS, Pulp & Paper, Gas Processing, & Industrial Flue Gases				

# Honeywell ORTLOFF CRYOGENIC FRACTIONATION



[Nathan.lozanoski@honeywell.com](mailto:Nathan.lozanoski@honeywell.com)

[www.honeywell.com](http://www.honeywell.com)

## SUMMARY

Honeywell UOP Ortloff CO<sub>2</sub> fractionation is an all-electric solvent-free option that captures CO<sub>2</sub> as a high-purity liquid product. Ortloff Dual Refrigerant CO<sub>2</sub> Fractionation (DRCF) processes provides bulk CO<sub>2</sub> removal from natural gas, PSA tail gas, and post-combustion streams while recovering the CO<sub>2</sub> as a liquid product while reducing energy consumption. Cryogenic fractionation can be coupled with a physical solvent, like Selexol™, a PSA, or a membrane system for optimised and integrated carbon capture flow schemes. Ortloff CO<sub>2</sub> Fractionation technology produces high-purity liquid CO<sub>2</sub> streams which can be pumped to the desired pressure for transport and storage.

Our cryogenic solutions are all-electric, highly automated, and can produce a high-purity liquid product ready for transport. Synergies between pressure swing adsorption and cryogenics can lead to cost savings. Our support spans the project life cycle from conceptual and feasibility studies, through Front End Engineering Design (FEED), commissioning startup and services during the operational life. Honeywell can deliver technologies through basic engineering packages as well as modular solutions to meet your needs. Honeywell provides extensive warranty and performance guarantees.

### ORTLOFF CRYOGENIC FRACTIONATION

- Application:** Designed for applications of recovery of natural gas liquids (NGL), liquefied petroleum gas (LPG), liquefied natural gas production (LNG), refinery off-gas and carbon capture to meet pipeline specifications.
- Description:** Cryogenic fractionation technology uses temperature and pressure controls to separate materials of varying boiling points and isolate specific chemicals from a given industrial process stream. When applied to CCUS, CO<sub>2</sub> is condensed out while the rest of the process stream remains in a gaseous state. The Ortloff CO<sub>2</sub> Fractionation system uses a proprietary blend of refrigerants to manage the temperature of the system, minimising the amount of equipment required and optimising the required power for the process.
- Technology Maturity:** Cryogenic fractionation is considered TRL 9 and has been in commercial operation since 1976 with over 400 units in operation.
- Advantages:** Cryogenic fractionation is an all electrically driven technology, produces a high purity product, and has lower equipment counts relative to amine solutions which reduce plot area.

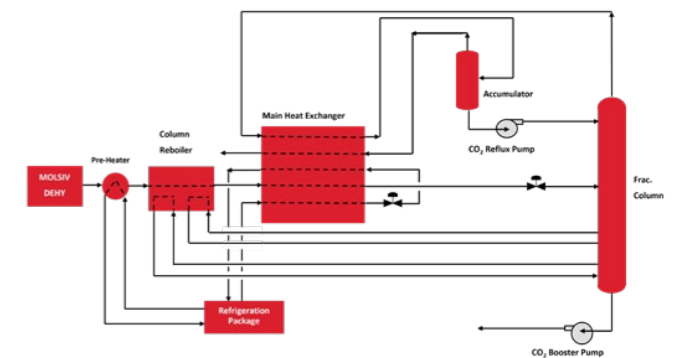

## KEY DATA

TRL	9	Capture Rate Range (tpd)	~	Modular (Y/N)	Yes
Source CO <sub>2</sub> Purity Range	~	Energy Consumption (GJ/tCO <sub>2</sub> )	~	Capture Efficiency (%)	~
Number of Commercial Plants	400+	Number of Pilot Plants	~		
Target Industries	Blue Hydrogen, Blue Ammonia, Steam Craker, Steel, Cement, Refining & Petrochemical, and Gas Processing				

# Honeywell POLYSEP™ MEMBRANES



[Nathan.lozanoski@honeywell.com](mailto:Nathan.lozanoski@honeywell.com)

[www.honeywell.com](http://www.honeywell.com)

## SUMMARY

Polysep systems combine state-of-the-art composite membrane technology with advances in polymer science. The Polysep membranes offer separation characteristics (permeability, selectivity, and contaminant resistance) that allow the design of an optimum system to fit a given process need. Polysep membrane systems are modular units containing hollow fiber membrane cartridges optimised for mechanical integrity and flow distribution. The cartridges are housed in modules, which are in turn mounted on a skid in series or parallel configurations depending upon feed gas volume and product requirements. High membrane packing density minimises system size and cost. Polysep™ is designed for efficient hydrogen recovery and purification. It features a pressure-driven process that minimises moving parts and operator involvement, making it an innovative solution with applications in various industries.

### POLYSEP™ MEMBRANES

- Application:** Hydrogen recovery and purification or rejection from various refining, petrochemical and chemical process streams. Feed streams include catalytic reformer off-gas, hydrotreater and hydrocracker purge gases, and fluid catalytic cracker off-gas. Chemical and Petrochemical feed streams include ethylene off-gases, ammonia plant purges, methanol plant off-gases, synthesis gas streams from steam reforming, partial oxidation and other gasification technologies.
- Description:** The Polysep system is based on state-of-the-art, composite hollow fiber polymer membrane technology. The hollow fibers are packed in a proprietary counter-current-flow bundle configuration that maximises the separation driving force and minimises required membrane area. The process is pressure driven and requires minimum moving parts, utilities or operator intervention.
- Technology Maturity:** Polysep is considered TRL 9 and has been in commercial operation since 1985 with over 85 units in operation. The largest unit processes more than 350 MMscfd of synthesis gas.
- Advantages:** Polysep operation features include automatic startup, capacity control, product purity control, auto depressurisation and turn-up / turn-down.

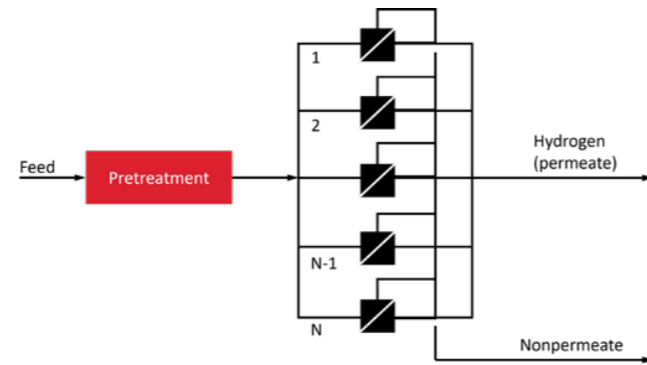

## KEY DATA

TRL	9	Capture Rate Range (tpd)	~	Modular (Y/N)	Yes
Source CO <sub>2</sub> Purity Range	~	Energy Consumption (GJ/tCO <sub>2</sub> )	~	Capture Efficiency (%)	~
Number of Commercial Plants	85	Number of Pilot Plants	~		
Target Industries	Refining & Petrochemical, Waste to Energy				

# Honeywell POLYBED™ PRESSURE SWING ADSORPTION (PSA)



[Nathan.lozanoski@honeywell.com](mailto:Nathan.lozanoski@honeywell.com)

[www.honeywell.com](http://www.honeywell.com)

## SUMMARY

The Polybed™ Pressure Swing Adsorption (PSA) System is optimised for H<sub>2</sub> purification and CO<sub>2</sub> rejection. It uses a series of pressurisation and depressurisation cycles with a bed of adsorbents to selectively provide high-pressure and high-purity hydrogen from a wide variety of gas streams. PSA technology can completely adsorb impurities allowing for the production of high purity hydrogen (typically 99.9+ mol-%) in a single unit with little consumption of utilities, contrary to the traditional multiple-unit flow schemes utilising acid gas removal wash systems and methanation reactors. The technology is thoroughly proven, with the first commercial PSA unit going on stream in 1966. Today, more than 1,150 Honeywell UOP PSA systems have been designed, fabricated and delivered worldwide. PSAs can also be selective for CO<sub>2</sub> capture in post-combustion applications.

Since its advent in the 1960s, continuous technical developments have supported the wide use of PSA systems in demanding applications. Honeywell believes that the current state of the technology will continue to be surpassed and that PSA systems of the future will feature higher performance and will be even better integrated in the refining, petrochemical, gas processing and carbon capture facilities.

### PRESSURE SWING ADSORPTION

- Application:** Pressure Swing Adsorption (PSA) systems have mainly been designed for applications for production of high purity hydrogen from syngas. PSAs can also be designed to purify CO<sub>2</sub> in post combustion capture service as well as CH<sub>4</sub>, He, N<sub>2</sub>, and Cl purification.
- Description:** PSA purification is based on advanced pressure swing technology. Units contain between 4 to 16+ absorber vessels, where one or more vessels is on adsorption step while others are in various stages of regeneration. All systems use advanced proprietary adsorbents and patented void-gas recovery techniques to provide maximum product recovery.
- Technology Maturity:** PSA is considered TRL 9 and has been in commercial operation since 1966 with over 1150 units worldwide.
- Advantages:** Operation is automatic, with push button startup and shutdown, and on-stream factors in excess of 99.8%. Units are compact requiring small plot space, and units are skid mounted and modularised to mitigate cost and installation time. All impurities for H<sub>2</sub> production are removed in a single step.

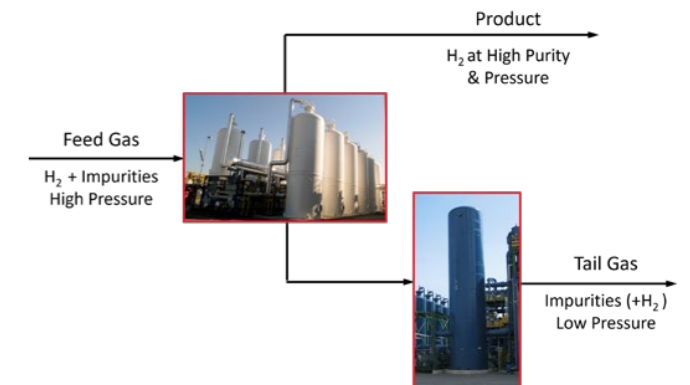

## KEY DATA

TRL	9	Capture Rate Range (tpd)	~	Modular (Y/N)	Yes
Source CO <sub>2</sub> Purity Range	~	Energy Consumption (GJ/tCO <sub>2</sub> )	~	Capture Efficiency (%)	~
Number of Commercial Plants	1150+	Number of Pilot Plants	~		
Target Industries	Blue Hydrogen, Blue Ammonia, Steam Craker, Steel, Cement, Refining & Petrochemical, and Gas Processing,				



[Nathan.lozanoski@honeywell.com](mailto:Nathan.lozanoski@honeywell.com)

[www.honeywell.com](http://www.honeywell.com)

**SUMMARY**

The SeparALL process is a well proven commercial process that uses Honeywell UOP's Selexol physical solvent to remove acid gases from synthetic or natural gas streams. It is ideally suited for the selective removal of H<sub>2</sub>S and COS and/or CO<sub>2</sub> to very low levels in the treated gas. Low sulfur levels can be achieved with variable and optimised CO<sub>2</sub> capture levels. The SeparALL process can also be used to remove and control mercaptan sulfur typically found in natural gas streams. The solvent will remove the minor amounts of ammonia, HCN, metal carbonyls and other contaminants that are typically found in synthetic gas streams. The SeparALL process can be tailored and optimised for either bulk or trace acid gas removal.

**SEPARALL**

- **Application:** Designed for applications on high pressure gas streams to selectively remove CO<sub>2</sub>, H<sub>2</sub>S, and carbonyl sulphide. Applicable processes include coal or biomass gasification, natural gas, ammonia syngas, hydrogen syngas, hydroprocessing upgraders, synthetic natural gas, chemicals, fertiliser and molecular sieve regeneration in CNG, LNG, and GTL front end treating removing and purifying gases to meet specifications as appropriate.
- **Description:** The SeparALL Process utilises Selexol physical solvent comprised of dimethyl ether of polyethylene glycol, where partial pressure is the key driving force. Feed gas is at an elevated pressure, wherein the H<sub>2</sub>S and CO<sub>2</sub> is removed in an absorption column, rich solvent is run through heat exchange and regenerated. Lean solvent is recirculated for more absorption.
- **Technology Maturity:** SeparALL is considered TRL 9 and has been in commercial operation since the 1960's with over 110 units worldwide.
- **Advantages:** Selexol solvent is chemically inert and not subject to degradation. It is a proven, versatile, efficient and reliable technology used for carbon capture for many years. Efficiency of the Selexol™ process for carbon capture is typically very high, with removal efficiencies of up to 99%. The process is reliable and easy to operate with >99% on-stream availability. Operators report simple startup with plants being brought online within 2 to 3 hours. Reclaiming and/or purging of solvent is not required. The SeparALL process has low corrosivity without the use of corrosion inhibitors.

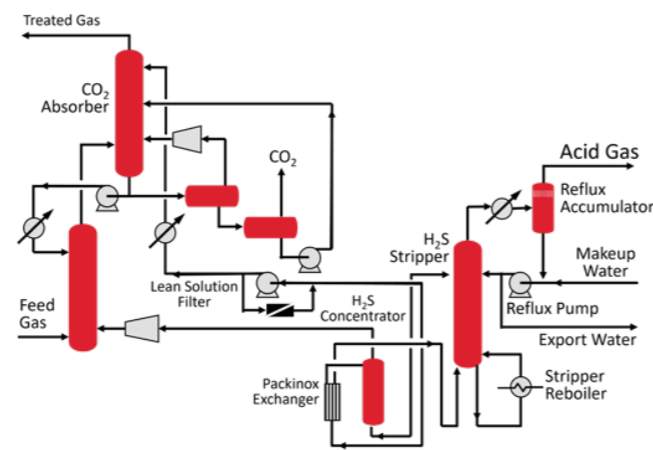

**KEY DATA**

TRL	9	Capture Rate Range (tpd)	~	Modular (Y/N)	No
Source CO <sub>2</sub> Purity Range	~	Energy Consumption (GJ/tCO <sub>2</sub> )	~	Capture Efficiency (%)	~
Number of Commercial Plants	110	Number of Pilot Plants	~		
Target Industries	Blue Hydrogen, Blue Ammonia, Steam Craker, Refining & Petrochemical, and Gas Processing, Biomass & Coal Gasification				



[Nathan.lozanoski@honeywell.com](mailto:Nathan.lozanoski@honeywell.com)

[www.honeywell.com](http://www.honeywell.com)

**SUMMARY**

Separex™ membranes are a bulk purification technology used to remove CO<sub>2</sub> and water from natural gas. They also remove H<sub>2</sub>S in roughly the same proportion as CO<sub>2</sub>. Hybrid systems, with membranes performing bulk removal of CO<sub>2</sub>/H<sub>2</sub>S followed by a solvent unit to meet low level specs are economically attractive. Separex membrane systems are designed for high, partial-pressure CO<sub>2</sub> capture in industrial applications. They are compact and lightweight, making them easy to install and operate, and can be used for a wide variety of gas streams. Separex systems are particularly well suited to remote locations where logistics are challenging. The 'single stage' design has no moving parts and is very low maintenance. They have simple, rapid startups and shutdowns and very high reliability. For offshore applications, UOP modular designs are smaller and lighter, lowering the total installed cost.

**SEPAREX™ MEMBRANE SYSTEMS**

- **Application:** designed for applications for removing CO<sub>2</sub>, H<sub>2</sub>S, and water vapour from natural gas to meet pipeline specification for onshore and offshore locations. Hydrogen and Helium purification and upgrading of low-GHV gas for fuel. De-bottlenecking existing solvent scrubbing systems or providing bulk removal upstream of new or existing installations. Hydrocarbon recovery from enhanced oil recovery floods for CO<sub>2</sub> reinjection and landfill and biogas purification.
- **Description:** Separex membrane systems are dry systems requiring minimal moving parts. Feed gas is conditioned (MemGuard™ is utilised when feed streams are heavy or require dewpoint control) and can be treated in one or two stage systems. Gases are pressurised and pass over polymeric membrane rapidly separating CO<sub>2</sub>, H<sub>2</sub>S, and water vapour permeate and are collected at low pressure. High value methane, ethane and other hydrocarbons and nitrogen are collected for sale. In a two-stage system the permeate from the first stage is compressed for further treatment and recovery.
- **Technology Maturity:** Separex is considered TRL 9 and has been in commercial operation since 1981 with over 150 units worldwide.
- **Advantages:** Separex is designed for operational simplicity, requiring minimal rotating equipment, no chemical reagent or replacement, and minimal services. Technology is delivered on prefabricated skids to minimise cost and plot space.

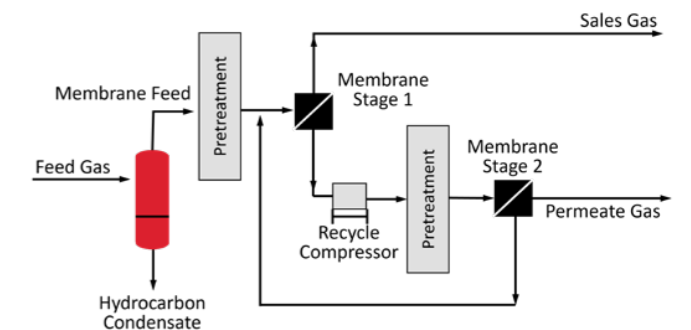

**KEY DATA**

TRL	9	Capture Rate Range (tpd)	~	Modular (Y/N)	Yes
Source CO <sub>2</sub> Purity Range	~	Energy Consumption (GJ/tCO <sub>2</sub> )	~	Capture Efficiency (%)	~
Number of Commercial Plants	150	Number of Pilot Plants	~		
Target Industries	Gas Processing, Biogas Upgrading, Renewable Natural Gas				

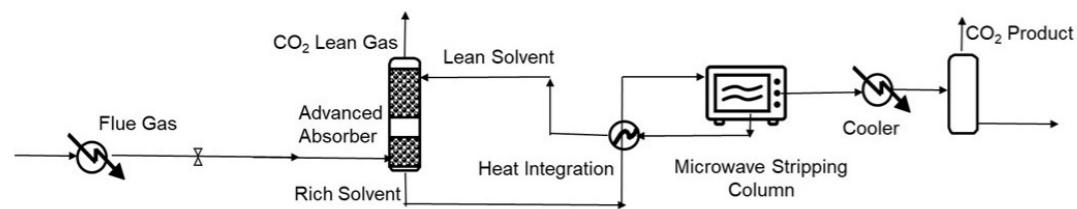

[aref.najafi@innotechalberta.ca](mailto:aref.najafi@innotechalberta.ca)

[www.innotechalberta.ca](http://www.innotechalberta.ca)

## SUMMARY

Amine processing is a well-established carbon capture technology used in industry for decades. While generally effective, the process lacks efficiency, which impacts operating costs, energy footprint, water requirements, throughput, and the net zero equation.

The primary objective of this project is to develop a de-risked and scaled solution to overcome these inefficiencies experimentally. Applying this knowledge to existing and new amine-based carbon capture units and improving their effectiveness, efficiency, and adoption will significantly impact industrial decarbonisation.

Previously, InnoTech Alberta set up a lab-scale configuration and leveraged learnings from the carbon capture unit at Alberta Carbon Conversion technology Center (ACCTC) to run different process scenarios that allow optimisation to be tested both by stage and as an integrated multi-stage process. Significant efficiencies were observed at the lab scale, warranting a third-party engineering techno-economic analysis to de-risk the scaling from lab scale to pilot scale.

## BENEFITS

- One of the most compelling aspects of this process is its potential to significantly reduce the capital and operating costs associated with capturing CO<sub>2</sub>. By achieving a 75% reduction in energy requirements compared to conventional amine-based processes, the Amine Intensification Process presents a substantial cost-saving opportunity for industries striving to reduce their carbon footprint.
- This process aligns with global efforts to transition to sustainable energy sources by electrification of the process. Its energy-efficient approach not only reduces operational costs but also contributes to a more sustainable energy consumption pattern, appealing to environmentally conscious industries. Industries utilising the innovation can demonstrate their commitment to carbon intensity reduction and sustainability, enhancing their brand image and positioning them as leaders in their respective sectors.
- With tightening regulations and emission reduction targets, the Amine Intensification Process offers a proactive solution for industries to comply with environmental standards and avoid potential penalties.

## KEY DATA

TRL	5	Capture Rate Range (tpd)	1	Modular (Y/N)	Yes
Source CO <sub>2</sub> Purity Range	4 - 6%	Energy Consumption (GJ/tCO <sub>2</sub> )	1.8	Capture Efficiency (%)	95%
Number of Commercial Plants	0	Number of Pilot Plants	1		
Target Industries	Oil and Gas and any point source CO <sub>2</sub> emitter				

## TECHNOLOGY DESCRIPTION

One of the challenges limiting the adoption of CCUS technologies is the energy intensity of commercial ready carbon capture processes. To address this challenge, InnoTech Alberta and its partners have demonstrated a concept, with the potential to reduce the energy demand, operational cost and carbon footprint. This process was developed to improve the existing and proven Amine-based CO<sub>2</sub> capture process. The proposed project aims to tackle two major challenges associated with the Amine based processes; high regeneration energy requirement and solvent degradation. The proposed project is called Amine Intensification process (AIP), the intensified process includes three significant improvements to the conventional amine process that, together deliver a step-change in carbon capture energy intensity and operational costs, including:

### 1 - ALTERNATIVE ABSORPTION TOWER:

The adoption of high-efficiency internal components in the column serves to reduce the size of the absorption column significantly. Numerous gas-liquid contactor designs have been created for gas treatment applications. However, a predominant proportion of currently installed contactors falls into either packed towers or tray towers. With the development of high-capacity, high-efficiency packings, packed towers are progressively gaining a larger share of the market. Structured packing has gained substantial consideration for amine scrubbing in CO<sub>2</sub> capture due to its favorable attributes, including minimal pressure loss, effective mass transfer capabilities, and straightforward installation. Within the CO<sub>2</sub> capture procedure, the efficacy of both the absorber and stripper hinges significantly on the packing's efficient mass transfer surface area.

### Characterisation of novel structured packings for CO<sub>2</sub> capture

InnoTech Alberta, in collaboration with Suzler Chemtech, has evaluated the potential utilisation of Suzler's advanced packing material (Mellapak™ CC The structured packing family for carbon capture), designed for CO<sub>2</sub> capture process with the potential to increase the mass transfer by 30% and reduce the pressure drop by 20%. Generally, only structured packing can meet the low-pressure drop requirements for the design of a direct contact cooler and the CO<sub>2</sub> absorber.

### 2 - MICROWAVE HEATING

Using microwave is motivated by recent literature highlighting microwave heating as an effective means of regenerating solid adsorbents or aqueous solutions for CO<sub>2</sub> capture and storage. Microwave, or dielectric, heating refers to the direct heating of a sample through interaction

with electromagnetic radiation. As such, microwaves offer instantaneous and volumetric heating without heat transfer restrictions associated with conventional conductive or convective heating. For polar solvents, such as water or MEA, microwave heating primarily takes place via the reorientation of molecular dipoles in the presence of the rapidly oscillating electric field. A phase lag between the molecular motion and the electric field causes friction between neighboring molecules, which ultimately leads to the dissipation of the electromagnetic energy into heat. Other important loss mechanisms occur through ion conduction in ionic solutions and Maxwell-Wagner polarization, resulting from interfacial phenomena, in inhomogeneous media. Harnessing these advantages, numerous applications of microwave heating have emerged in recent decades, encompassing fields such as material synthesis, food processing, and chemical reactions. Regarding monoethanolamine (MEA), it was observed that microwave-based regeneration has the ability to release CO<sub>2</sub> at lower temperatures and in a more expedited manner in contrast to traditional regeneration methods. This has the potential to decrease the energy cost associated with a TSA (temperature swing adsorption) process that employs MEA. Similarly, existing literature on microwave-assisted CO<sub>2</sub> desorption from solid sorbents has demonstrated notably quicker CO<sub>2</sub> release rates compared to conventional desorption techniques.

### 3 - WATER LEAN SOLVENT (WLS)

The primary challenge associated with this process is the significant energy requirement for CO<sub>2</sub> capture, which constitutes roughly 70% of the total cost. This substantial energy demand has been a major obstacle to the widespread adoption of CCUS. It is widely understood that the primary contributor to this energy demand is the heat duty of the reboiler, a crucial component in regenerating the solvent. This energy is essential for breaking the chemical bond between CO<sub>2</sub> and MEA at elevated temperatures in the stripper, encompassing both the necessary sensible heat and the latent heat needed for solvent vaporisation. Additionally, this regeneration process leads to considerable deterioration in the performance of the MEA absorbent, resulting in a rapid decline in its ability to capture CO<sub>2</sub> effectively. From an energy consumption perspective, the use of water as a solvent presents a significant challenge in these aqueous systems due to its high heat capacity and latent heat properties. Therefore, the adoption of water-lean absorbent systems, achieved by substituting water with organic solvents characterised by lower specific heat and volatility, emerges as an attractive alternative to mitigate the substantial energy requirements. Our laboratory findings confirm that the use of Water Lean Solvent (WLS) allows us to cut energy requirements in half compared to conventional solvents.



[info@ioncleanenergy.com](mailto:info@ioncleanenergy.com)

[www.ioncleanenergy.com](http://www.ioncleanenergy.com)

**SUMMARY**

ION Clean Energy’s ICE-31 post-combustion carbon capture technology has demonstrated transformational performance at the engineering-scale and large pilot-scale by capturing between 95%-99% of CO<sub>2</sub> emissions with extremely low emissions, unprecedented solvent stability and low energy requirements. ION’s ICE-31 technology is particularly well suited to high oxygen environments, like NGCC power generation, where the solvent’s resistance to oxidative degradation shines, resulting in the low emissions that minimise the adverse impact typically seen with implementation of other amine-based technologies.

**BENEFITS**

- **Unprecedented Solvent Stability.** Extreme stability and resistance to oxidative degradation extends the life of the solvent without losing capture efficiency. As a result, frequency of solvent replacement and disposal are decreased and overall capture performance is enhanced while the total cost of capture is reduced.
- **Extremely Low Emissions.** Emissions from the ICE-31 solvent fall below detectable levels of current CEMS. This minimises the adverse impact typically seen with implementation of other amine-based technologies.
- **Fast Solvent Kinetics.** ION’s ICE-31 solvent has a fast reaction with CO<sub>2</sub>, resulting in reduced opex and capex costs as less solvent and smaller equipment are required.
- **Lower Energy Requirements.** ION’S ICE-31 solvent is energy efficient and requires less energy to regenerate the solvent. As less energy is required, operating costs decrease while capture efficiency rates of more than 95% are maintained.

**KEY PROJECTS**

- **Enterprise Pilot At Calpine’s Los Medanos Energy Center.** A first-of-its-kind pilot designed and built to ION’s specifications to demonstrate the performance of ICE-31 on a 1 MWe slipstream of NGCC flue gas from a commercially dispatched power plant in Pittsburg, CA, USA. ION aims to operate the pilot for over 10,000 hours of ICE-31 testing including parametric study, dynamic and long-term end-to-end operations.
- **Tampa Electric Company’s Polk Power Station.** ION is working with Tampa Electric to complete a FEED study to design and determine the cost of retrofitting ION’s capture technology onto the NGCC power plant at the Polk Power Station Unit 2 (PK2). This project will be designed to capture a minimum of 95% of the CO<sub>2</sub> emissions, which equates to nearly 3 million metric tons of CO<sub>2</sub> per year. The carbon captured will be transported for secure geologic storage. The PK2 CCS project has received significant funding for development through US Department of Energy programs.

**KEY DATA**

TRL	7	Capture Rate Range (tpd)	10 – 10,000	Modular (Y/N)	No <sup>1</sup>
Source CO <sub>2</sub> Concentration	3 – 20%	Energy Consumption (GJ/tCO <sub>2</sub> )	2.4 – 2.8	Capture Efficiency (%)	95 - 99%+
Number of Commercial Plants	5	Number of Pilot Plants	4		
Target Industries	NGCC power generation and industrial processes				

<sup>1</sup> However, a pre-fabricated, modularly delivered offering is in development.

**TECHNOLOGY DESCRIPTION**

**EXTREMELY LOW EMISSIONS**

ION operated an ICE-31 campaign at The National Carbon Capture Center (NCCC) for over 4,200 hours between March and October of 2021, including parametric and long-term steady-state testing using NGCC-type flue gas (4.4% CO<sub>2</sub>), real gas-fired boiler gas (7.8% CO<sub>2</sub>) and real coal-fired flue gas (13% CO<sub>2</sub>). The Pilot Solvent Test Unit (PTSU) emissions were continuously monitored out of the water wash and extractive sampling showed resulting NH<sub>3</sub> of less than 1 ppm. In addition to the extractive sampling, solvent components were also analysed by RJ Lee, a third-party emissions analysis lab, which found the solvent components to be below the 40 ppb detection limit.

Since ION could not analyse the flue gas outlet from the Upper Water Wash (UWW), the focus shifted to Lower Water Wash (LWW) flue gas outlet, which was also below the detection limit of the analyser. A more sensitive measurement of the UWW circulating water was conducted to understand the amount of carryover from the LWW. When the LWW was in continuous operation, solvent component concentration in the UWW dropped significantly (Figure 1). These data points demonstrate the low volatility of the ION solvent when utilising the dual-stage water wash.

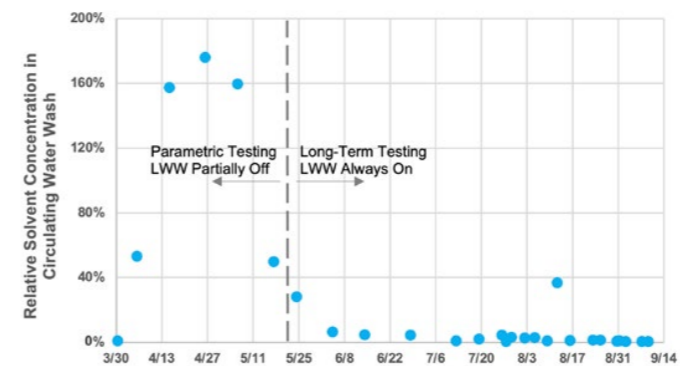

Figure 1: Solvent concentration in circulating upper wash water with different lower water wash operating conditions

**ICE-31 STABILITY**

Lab studies have focused on accelerated oxidative and thermal degradation. ION performed accelerated oxidative experiments at 80 °C with sparged air containing 10% CO<sub>2</sub> while thermal degradation studies were performed in closed vessels at 135 °C with minimal headspace. The resulting ICE-31 degradation is extremely low under these extreme environments, demonstrating unparalleled stability in literature comparison to other amines and amine systems. Heat-stable salts that originate from trace contaminants in the flue gas are formed over the course of several months and may be cost-effectively reclaimed in a semi-batch process using electrodialysis.

**THERMODYNAMIC PERFORMANCE OF ICE-31**

A high working capacity, a measure of how much CO<sub>2</sub> can be held by a specific volume of solvent, is a vital requirement in a transformational CO<sub>2</sub> capture solvent and is a function of solvent concentration, desorption energy requirements and circulation rate. This, coupled with a high CO<sub>2</sub> vapour pressure in equilibrium with the solvent at a given lean loading and stripper temperature, results in a more efficient use of stripping steam in the regenerator. The increased working capacity of ICE-31 also lowers the liquid flow rate required to maintain constant capture, in turn lowering pump power, lean-rich heat exchanger size, and reboiler duty attributed to sensible heat.

**LOWER ENERGY USE: SRD VERSUS CAPTURE EFFICIENCY**

Another work package at NCCC focused on varying the capture efficiency of the PSTU while simultaneously choosing optimal L/G ranges to determine minimum SRD performance at each capture efficiency. 18 m absorber height was tested for capture efficiency; a 24 m absorber height was also modeled in ProTreat® after parametric testing (Figure 2). With 18 m of packing, the CO<sub>2</sub> mass transfer into the solvent was fast enough to reach a similar rich loading across the entire capture efficiency range. The modeled 24 m absorber significantly outperformed the measured performance in the 18 m absorber only at very high capture efficiencies above 97%. Due to ICE-31’s stability, ION is able to drive leaner solvent loadings, which results in higher capture efficiency up to 99%.

The overall impact of the fast kinetics and favorable thermodynamics of ION’s ICE-31 solvent demonstrate that there is only a 4% SRD penalty when increasing capture from 90% to 98%, even when using a simple stripper in this drop-in facility that was not optimised for ICE-31. Further optimisation with cold-rich bypass allows even leaner optimal lean loadings and a smaller penalty when increasing capture efficiency.

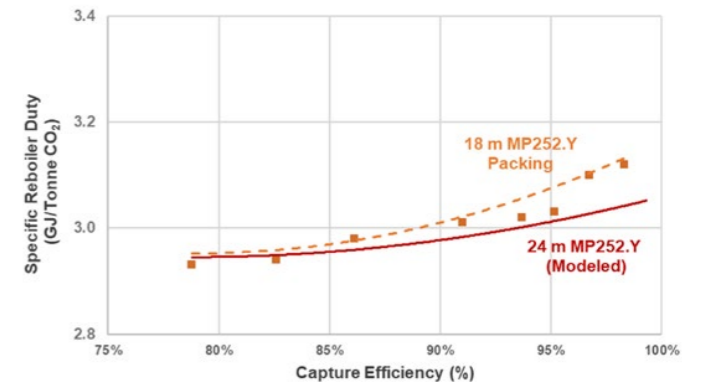

Figure 2: SRD at Optimal L/G for varying capture efficiencies with 4.4% inlet CO<sub>2</sub> measured at 18 m MP252.Y absorber packing height and modeled at 24 m MP252.Y absorber packing height.



K2-CO2

K2-CO2



[amonteforte@K2-CO2.com](mailto:amonteforte@K2-CO2.com)

[www.K2-CO2.com](http://www.K2-CO2.com)

### SUMMARY

K2-CO2 delivers fully integrated turnkey Carbon Capture Use & Sequestration (CCUS) solutions targeting small and medium scale industrial emitters. Our portfolio includes turnkey solutions to satisfy from the exit of combustion source to the exhaust stack including carbon capture integrated with flue gas conditioning, waste heat recovery, and reuse or sequestration. These solutions integrate into an existing process without impacting the production, resulting in a reduction of environmental emissions, overall energy impact, and CO<sub>2</sub> footprint.

Our team leverages its extensive experience as industrial flue gas treatment integrators to offer a safe, energy-efficient, “bolt-on” carbon capture system utilising Hot Potassium Carbonate (HPC) solvent with the needed conditioning for sequestration or reuse. The HPC-solvent process for CO<sub>2</sub> capture, licensed by Giammarco Vetrocoke, is used globally in industries such as chemical plants with high CO<sub>2</sub> concentrations in the flue gas: K2-CO2 has extended the usefulness to lower CO<sub>2</sub> concentrations, making it suitable for most combustion-derived flue gas.

### BENEFITS

- **No Upstream Process Modifications:** Our systems integrate into existing processes without upstream modification of conditions or fuel required and include Use and/or Storage, providing tailored solutions to the unique process and site.
- **Energy Efficient:** Energy demands for heating/cooling and expansion/compression are minimised through energy re-use throughout the process.
- **Cost Effective:** Minimal changes to combustion process, waste heat recovery, and solvent regeneration provide a cost-effective solution for CCUS in small to medium size emitters.
- **Continuous Compliance:** Highly effective air pollution control technology is integrated for other flue gas pollutants.
- **Safe and Environmentally Friendly:** Hot Potassium Carbonate (HPC) is a non-flammable, nontoxic, stable and inexpensive solvent, eliminating the need for harmful and corrosive amine-based capture processes.

### KEY DATA

TRL	7	Capture Rate Range (tpd)	20 - 400	Modular (Y/N)	~
Source CO <sub>2</sub> Concentration	~	Energy Consumption (GJ/tCO <sub>2</sub> )	~	Capture Efficiency (%)	> 95%
Number of Commercial Plants	~	Number of Pilot Plants	~		
Target Industries	Glass, Cement, Steel, Waste to Energy				

### TECHNOLOGY DESCRIPTION

The K2-CO2 process comprises of a dry section and wet section connected in series.

The dry section is comprised of the Air Pollution Control system and heat recovery stages to meet the heat needs required by the carbon capture process.

This section can utilise existing air pollution control equipment on-site with the integration of heat recovery stages or can be provided as new equipment. It must be noted that the flue gas can exit the system by bypassing the wet section via an exhaust stack to maintain continuous emission compliance in the event of an emergency or maintenance on the wet system.

The wet section is comprised of a deSO<sub>x</sub> process, CO<sub>2</sub> absorption, and CO<sub>2</sub> cooling and concentration.

The deSO<sub>x</sub> process provides further removal of contaminants and additional conditioning of the flue gas stream to begin the CO<sub>2</sub> recovery process.

The absorption section, utilising the well-known carbon capture technology of Hot Potassium Carbonate (HPC), absorbs CO<sub>2</sub> from the flue gas stream into the HPC water solution. The remaining flue gases, which have already been treated in the dry section, are emitted to the atmosphere.

The CO<sub>2</sub>-rich HPC solution is then heated to release the highly concentrated CO<sub>2</sub> product in a stripping process. The HPC solution is regenerated and injected into the absorber in a loop system, requiring no continuous make-up of the solution.

The CO<sub>2</sub> is collected, conditioned, and sent for the chosen use or storage solution for the process. The captured CO<sub>2</sub> can be sent to the conditioning plant, designed to deliver the desired CO<sub>2</sub> quality, pressure and temperature for use or storage: underground, for enhanced oil recovery or mineralisation.

The conditioning technology is adapted to the effective needs and can cover from simple storage/delivery in gas phase to purification and liquefaction or compression to supercritical conditions.

The K2-CO2 HPC process is a classic absorption/stripping process but is operated at relatively low pressures (typically 0.5-5 barg) and integrates all possible heat recovery stages. The process is designed to have zero external heat needs, making it less energy-intensive than other CCUS technologies, including those utilising a similar solvent or amine-based systems. It can be applied to a wide range of industrial processes such as glass, steel, biomass/waste incineration.

HPC technology has been chosen against Amines for several reasons. These include that HPC solution is safe for people and the environment, non-volatile, stable, inexpensive, and based on a readily and worldwide available basic component that is not provided by a propriety source, manufacturer, or licensor.

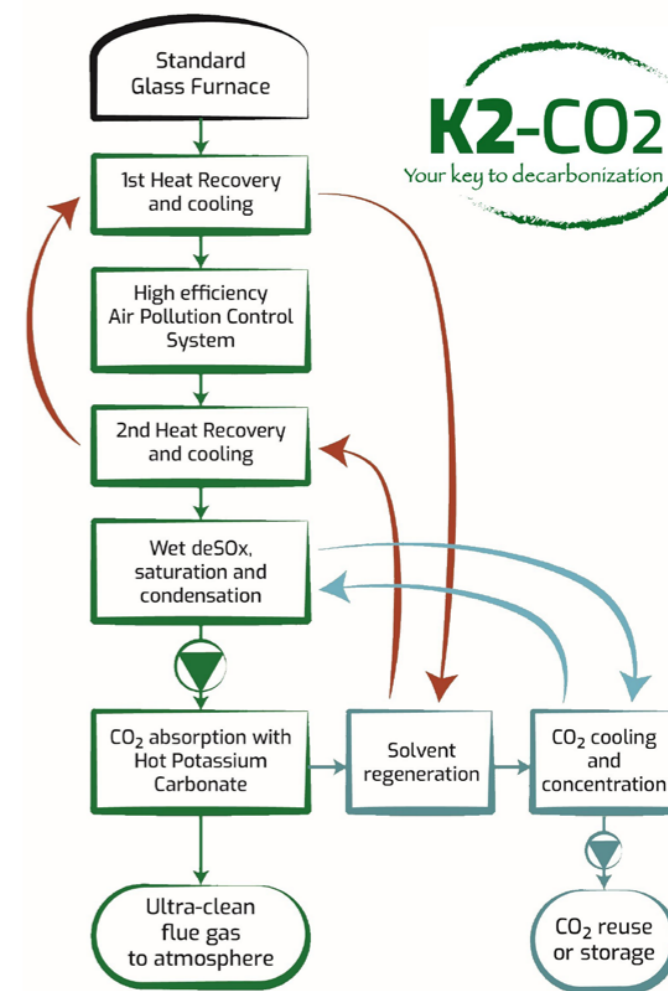



[greg.ross@KC8capture.com](mailto:greg.ross@KC8capture.com)

[www.KC8capture.com](http://www.KC8capture.com)

**SUMMARY**

KC8 Capture Technologies is commercialising industry leading carbon capture technology that provides an affordable pathway to reduce greenhouse gas emissions from the resource, production and energy sectors across the globe. Our groundbreaking UNO MK 3 technology employs an innovative precipitating potassium carbonate ( $K_2CO_3$ ) solvent, enabled by our patented solids-tolerant process design. This unique approach allows for increased solvent loading, resulting in decreased CAPEX costs and a smaller plant footprint, in addition to decreased energy usage. Further benefits include elimination of wash stages and major environmental and safety advantages. Moreover, UNO MK 3 boasts superior tolerance to oxygen, SOx, and NOx in source flue gas, broadening its application scope to challenging sectors like cement, steel, waste-to-energy, and gas turbine-based power generation. Two demonstration-scale facilities are set to commence operations in late 2024 / early 2025, which in conjunction with planned FEED studies are forecast to demonstrate carbon capture capabilities at a competitive cost range of \$35-40 per tonne of  $CO_2$ .

**BENEFITS**

- **Lower cost and energy usage** – achieving up to 50% reduction in cost and 15% reduction in energy usage compared to the best amine equivalent.
- **Oxygen, SOx and NOx tolerant process** – allowing diverse application portfolio including cement, steel and waste-to-energy.
- **Low cost, safe solvent with pre-existing supply capacity** – with current potassium carbonate market orders of magnitude larger than forecast  $CO_2$  capture demand.
- **Small plant footprint and low impact retrofit integration** - all achieved through higher solvent loadings and design innovations which minimise upstream process impact.
- **Superior environmental performance** – environmentally benign solvent with low volatility and no toxic byproduct formation eliminates need for toxic waste disposal, complex wash stages and solvent reclamation unit.
- **Option to time shift energy demands** – large scale solvent storage viable due to unique solvent characteristics.

**KEY PROJECTS**

- **PACER Demonstration Plant** – 10-15 tpd  $CO_2$  facility being constructed in partnership with Cement Australia and LET Australia, focusing on clinker flue gas processing from a pre-existing industrial plant. Operations will be located at a Cement Australia facility in Gladstone, Australia.
- **UNOGAS Demonstration Plant** – 5-10 tpd  $CO_2$  facility being developed at the National Carbon Capture Centre (NCCC) as the second stage of the US DoE FleCCS project. This project will focus on optimising the performance in lower  $CO_2$  concentrations such as those found in gas turbine flue gas during steady state operation, ramp-up / ramp-down and time-shifting of solvent regeneration to improve flexibility of power generation in high renewable penetration grids.

**KEY DATA**

TRL	6 - 7	Capture Rate Range (tpd)	50+	Modular (Y/N)	Yes
Source $CO_2$ Purity Range	3 - 25%	Energy Consumption (GJ/t $CO_2$ )	2.2 - 2.6	Capture Efficiency (%)	90%+
Number of Commercial Plants	0	Number of Pilot Plants	2		
Target Industries	Cement, Steel, Waste-to-energy, Power, BECCS				

**TECHNOLOGY DESCRIPTION**

**THE UNO MK 3**

Following the invention of the UNO process within the Cooperative Research Centre for Greenhouse Gas Technologies (CO2CRC), the technology has subsequently been developed over the last decade by KC8 Capture Technologies in conjunction with the University of Melbourne in Australia. The current generation of the technology, the UNO MK 3, consists of a catalytically enhanced precipitating potassium carbonate solvent technology. It is engineered to capture over 90% of carbon dioxide ( $CO_2$ ) emissions from heavy industry sources such as cement plants, power stations (pre- and post-combustion) and other  $CO_2$  emitting industries.

Potassium carbonate ( $K_2CO_3$ ) has been used in solvent absorption processes in chemical industries for many years (i.e. the Benfield process). The patented UNO MK 3 process provides a unique update to this established technology, making it highly efficient for  $CO_2$  capture at low pressure. The UNO MK 3 process contains the absorption and regeneration stages of a standard solvent absorption process. However, unlike a standard liquid-based solvent system, a  $KHCO_3$  precipitate is allowed to form. This allows UNO MK 3 to use a more concentrated solvent and greater  $CO_2$  loadings. That, in turn, allows for greater working capacities, lower circulation rates and drives down energy requirements.

**TECHNOLOGY STRENGTHS**

To handle solid precipitation in the process, KC8 Capture has conducted extensive R&D to identify and adapt existing process units to meet the challenging requirements. Central to this has been our patented refinement of Turbulent Bed Contactor technology to not only facilitate suitable solids tolerance in the absorber unit, but also provide process intensification, resulting in reduced column height relative to conventional amine processes.

A key benefit of potassium carbonate-based solvents is the significantly lower volatility compared with amine-based solvents. The volatile emissions from amine-based solvents can be significant and usually requires an additional water wash sections as well as continuous solvent make-up. In contrast, the UNO MK 3 process neither requires a water wash stage, nor complex reclamation sections to achieve economic viability.

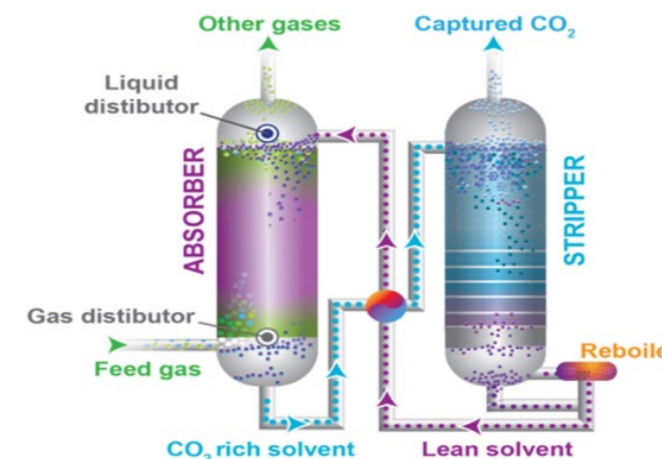

Figure 1: Conventional dual absorption / stripping columns

**APPLICATIONS**

The UNO MK 3 process can handle a wide range of applications, including both pre- and post-combustion electricity generation and other industrial  $CO_2$  emitting processes. It is unaffected by the impurities in a range of fuel source including black coal, brown coal, natural gas and emissions from cement, iron and steel and other heavy industries. Due to its oxygen tolerance and low volatility, it is also highly applicable in capture from natural gas turbines in either open or closed cycle flue gases. It also has the capacity to be applied either as a new build or retrofit application.

KC8 has developed innovative configurations for large-scale contacting systems, such as a novel patented concentric single stream absorption and stripping combined columns. This enables larger column diameters and improves CAPEX performance comparative to conventional steel arrangements.

**CURRENT STATUS**

Pilot plant testing at Hazelwood Power Station in Australia has been completed, and two demonstration facilities are underway as outlined in Key Projects. These projects will take KC8 Capture through to a TRL of 7-8, at which point we will be ready to commence construction of commercial scale facilities. Current estimates are that typical applications at full scale will be able to achieve  $CO_2$  capture costs of \$35-40 /tonne.

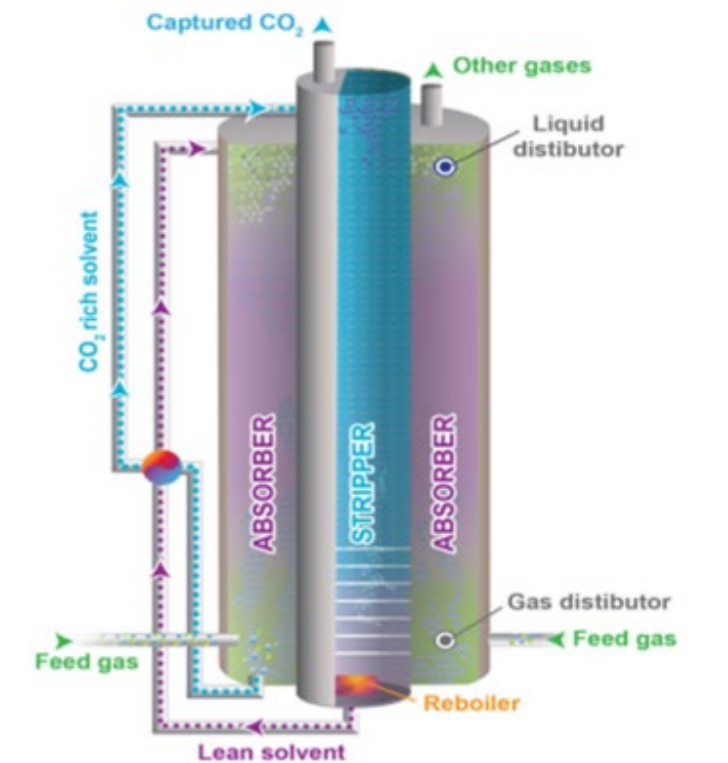

Figure 2: KC8 patented concentric absorption / stripping column



[contact@leilac.com](mailto:contact@leilac.com)

[www.leilac.com/](http://www.leilac.com/)

### SUMMARY

Leilac is accelerating the transition to net zero by providing the most compelling decarbonisation solution for global cement and lime industries and enabling the removal of atmospheric carbon dioxide (CO<sub>2</sub>) through our partnership with Heirloom, a DAC company.

Our core technology uses calciner tubes to indirectly heat limestone (CaCO<sub>3</sub>) or cement raw meal. This unique approach re-engineers the existing process flows of a conventional calciner to keep the combustion products separate from the calcination products. The CO<sub>2</sub> generated from calcination (process emissions) remains uncontaminated and is captured at high purity (>98%).

Leilac's technology delivers a first-principles approach to capture unavoidable process emissions. By avoiding the need to separate gases from gases or use additional chemicals or solvents, there is minimal energy penalty and, crucially, minimal cost. It is also retrofittable, scalable, and compatible with alternative fuels, electrification, renewable energy, and combustion emissions capture, to provide viable, economical, and future-proof solutions for net-zero cement and lime.

### BENEFITS

- Targeting the lowest cost decarbonisation of cement and lime
  - ~€33/tonne CO<sub>2</sub> of process emissions avoided<sup>1</sup>
  - ~€39/tonne CO<sub>2</sub> for near-zero emissions cement<sup>1</sup>
- >98% pure CO<sub>2</sub> reduces Compression and Purification Unit costs
- No additional chemicals or solvents
- Scalable modular design
- Low impact retrofit with minimal downtime
- Flexible layout and integration options
- Future-proof fuel optionality, including alternative fuels and electrification
- Proven core technology with >8000 hours of operations
- Multiple pathways to net zero

### KEY DATA

TRL	6	Capture Rate Range (tpd)	Unlimited, >70 TPD	Modular (Y/N)	Yes
Source CO <sub>2</sub> Purity Range	>98%	Additional Energy Consumption (GJ/tCO <sub>2</sub> )	0 - 0.6 GJ/nth of a kind	Capture Efficiency (%)	95%
Number of Commercial Plants	0	Number of Pilot Plants	4	Calcination Rate	Up to 98%
Target Industries	Cement, Lime, and Direct Air Capture				

## TECHNOLOGY DESCRIPTION

### OUR STORY

Leilac's technology is a first-of-its-kind. It was developed for, and in partnership with, the cement and lime industries to deliver a uniquely efficient industrial decarbonisation solution.

Leilac's technology is proven at pilot scale at Leilac-1, and in three smaller electric units – and the core technology has been used at a commercial MgO plant, separating process CO<sub>2</sub> since 2013. Leilac-1 opened in 2019 with a capture capacity of 25,000 tonnes of CO<sub>2</sub> per year, with support from the European Union's Horizon 2020 programme and a consortium of industry partners. Located at the Heidelberg Materials' plant in Lixhe, Belgium, it remains the largest carbon capture installation for cement in the world outside China.

Leilac-2, a demonstration plant in Germany, will be constructed in 2025. With a target capture capacity of 100,000 tonnes of CO<sub>2</sub> per year and located at Heidelberg Materials' Ennigerloh cement plant, Leilac-2 aims to validate a replicable, retrofittable module that is compatible with renewable and alternative fuel sources for any scale.

In addition to our pilot and demonstration plants, Leilac has many commercial projects in development across the world to assess suitable decarbonisation options and implement near-term and commercially relevant solutions.

### OUR TECHNOLOGY

Leilac's technology provides an efficient calcination solution that captures unavoidable process CO<sub>2</sub> emissions as a pure and recoverable stream. At the heart of the technology is a module of calciner tubes that deliver radiative heat to limestone or cement raw meal. When the material is heated and converted to lime, it releases CO<sub>2</sub> trapped in the limestone as a direct and unavoidable result of the chemical reaction. These 'process' emissions typically account for 60% of the total CO<sub>2</sub> emitted from cement and lime production, depending on the type of fuel used.

This unique approach effectively replaces the precalciner in a conventional cement-making process. It theoretically requires no additional energy input compared with conventional cement and lime production and can be simply integrated with an operational plant using its fuel of choice.

Leilac's technology is different from other capture technologies since it avoids the additional energy consumption – and cost – associated with separating gases from gases. Leilac's unique combination of inherent fuel flexibility and low energy penalty means that it can simply and economically scale to capture the process emissions from any plant, at >98% purity, eliminating the need for costly purification steps and reducing the cost of CO<sub>2</sub> compression.

Leilac has also partnered with Heirloom, a direct air capture (DAC) company permanently removing CO<sub>2</sub> from the atmosphere. Leilac's core technology is the only known way of electrifying the lime and cement industries at scale and will be central to the operation of Heirloom's DAC facilities that needs to only use renewable electricity to separate CO<sub>2</sub> as efficiently as possible as a core part of that process.

The partnership with Heirloom will further accelerate the development of electric calcination, at million tonne per annum capture rates, which can then be applied to industrial decarbonisation solutions.

### LOW IMPACT

The Leilac technology can be retrofitted to a typical cement plant with minimal downtime. For many host plants, Leilac's technology can be built alongside ongoing cement operations, and then integrated during a typical annual maintenance period. Leilac's modular design can enable flexible layout and integration options tailored to each host plant.

### TOWARD NET ZERO

While Leilac's core technology captures only process emissions, Leilac can use alternative and renewable fuels, such as electricity, biomass, and hydrogen, for overall avoidance rates approaching 100%. An alternative approach is to operate in tandem with any viable post-combustion capture technology to remove the combustion CO<sub>2</sub>. The significantly reduced quantity of carbon to be captured means that the relatively small post-combustion capture unit can be powered largely by waste heat provided by the cement plant's flue gas. This decreases both capital and operating expenses.

### HOW WE WORK

Leilac's roadmap is based on scaling up its solutions through the duplication of a proven module to work with any cement or lime plant, anywhere in the world. Each plant is unique, however, and coupled with different regulatory mechanisms and carbon management infrastructure to manage the transition to net zero, the decision on how, and when, to decarbonise a plant is not an easy one for manufacturers. Leilac accommodates this through flexibility and offering technology options that can adapt to many different circumstances and still provide strong economies of scale.

To accomplish this, Leilac listens to, and collaborates with, its partners to create rigorous scoping studies containing detailed and plant-specific analysis of appropriate retrofit and integration options. Leilac evaluates design and energy options in the context of a plant's local circumstances, like the host plant layout, current and future local fuel options, and the preferences of the plant owner regarding scope and schedule.

As demand for Leilac's solutions grow around the world, so does our team. Leilac now has employees in 13 countries across the world, speaking 25 languages. Our people bring a breadth and depth of industry experience.

Partnerships are at the core of Leilac. With a focus on maximising the scale and speed of our impact, Leilac will provide its solutions through a blueprint model for construction by local companies, using local resources. It is a framework designed to provide low-cost decarbonisation options for local industry as part of a just transition to net zero.

<sup>1</sup> Decarbonising Cement: Leilac at Full Commercial Scale. Includes CO<sub>2</sub> compression, maintenance, and CAPEX repayment. Excludes CO<sub>2</sub> transport and storage <www.leilac.com>





LINDE

## ADVANCED AMINE-BASED POST-COMBUSTION CO<sub>2</sub> CAPTURE (PCC)



[ccus@linde.com](mailto:ccus@linde.com)

[www.engineering.linde.com/CO<sub>2</sub>](http://www.engineering.linde.com/CO2)

### SUMMARY

Post-Combustion CO<sub>2</sub> Capture (PCC) is a mature option to capture CO<sub>2</sub> from flue gas streams. With the OASE® blue technology, CO<sub>2</sub> is removed from the flue gas through chemical scrubbing with an aqueous amine-based solvent. It can be implemented downstream of existing assets without interfering with upstream processes. For new assets, advanced plant integration concepts and optimised total costs of ownership can be accomplished.

The optimal design of turnkey facilities using OASE® blue technology has been jointly developed by BASF and Linde. It leverages BASF's capabilities in high-performance gas treatment technologies and Linde's strength and proven track record in design and delivery of turnkey industrial plants. This results in an optimal interplay of solvent, process design, equipment, and plant integration. In combination with our solid track record in large-scale gas treatment plants, this high-performance CO<sub>2</sub> capture technology ensures low risk in EPC projects.

### HIGHLIGHTS

- Compact footprint
- High CO<sub>2</sub> capture rate even at low CO<sub>2</sub> concentrations
- With a final CO<sub>2</sub> product purity of 99.9 vol% (dry), a further purification step may not be necessary
- 20% lower energy consumption and 20% lower circulation rate compared to MEA solution
- Low solvent degradation rate even at elevated oxygen content in flue gas, and therefore low solvent consumption rate
- Different options for energy and heat integration
- Unique emissions control technology for minimum environmental impact
- > 500 OASE® gas treatment plants in operation for different applications
- > 65,000 hours of operational experience with OASE® blue
- Reference plants in Germany and the United States

### KEY PROJECTS

- The joint venture of Heidelberg Materials and Linde received a building permit for a CO<sub>2</sub> capture and liquefaction plant at Heidelberg Materials' site in Lengfurt, Germany. With the achievement of this major milestone, building activities have commenced.
- A major 10-megawatt carbon capture pilot project for City Water, Light and Power (CWLP) in Springfield, Illinois, is on track to start up later this year. The Linde/BASF Advanced Post-Combustion CO<sub>2</sub> Capture Technology used in this project is a major step in demonstrating how capture technologies can be successfully integrated into industrial facilities to reduce CO<sub>2</sub> emissions.

### KEY DATA

TRL	9	Capture Rate Range (tpd)	200 - 7,000	Modular (Y/N)	Yes
Source CO <sub>2</sub> Concentration	3 - 25%	Energy Consumption (GJ/tCO <sub>2</sub> )	2.5 - 3.2	Capture Efficiency (%)	>95%
Number of Commercial Plants	>60	Number of Pilot Plants	3		
Target Industries	Cement & lime, power generation (natural gas, biomass, coal), iron & steel, petrochemical, oil & gas				

### TECHNOLOGY DESCRIPTION

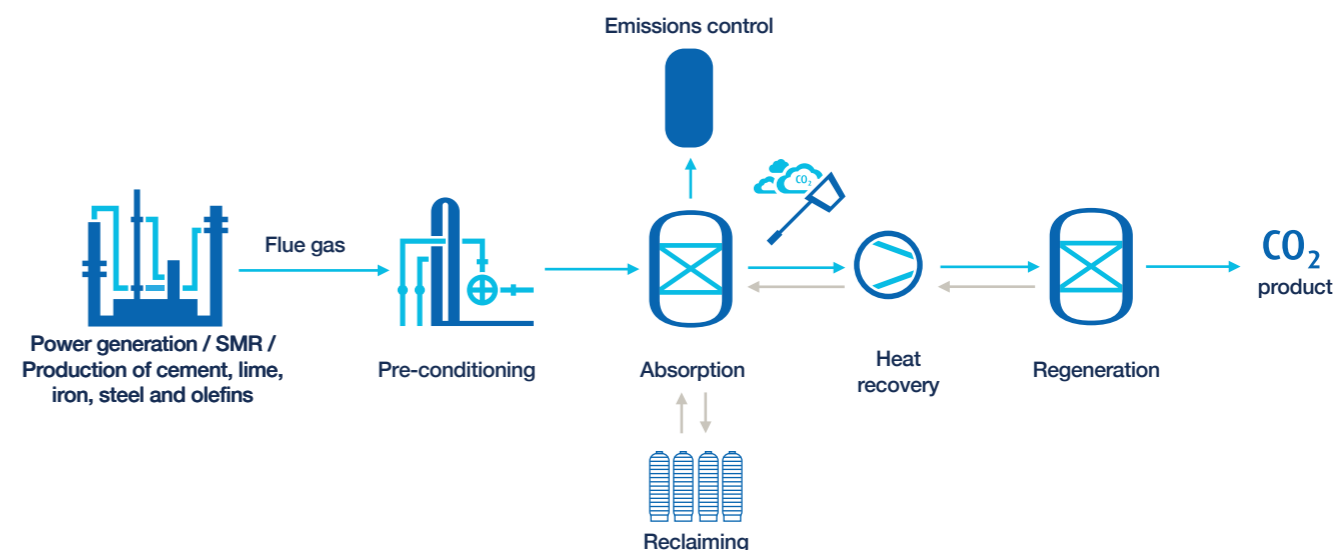

OASE® blue post-combustion CO<sub>2</sub> capture (PCC) process

OASE® is a registered trademark of BASF SE



LINDE

# HISORP® CC



[ccus@linde.com](mailto:ccus@linde.com)

[www.engineering.linde.com/CO2](http://www.engineering.linde.com/CO2)

## SUMMARY

HISORP® CC is a sophisticated carbon capture solution that combines Linde's proprietary adsorptive and cryogenic technologies. It takes a toolbox approach, prioritizing the reduction of carbon footprint while minimising total costs, especially for industries with high CO<sub>2</sub> emissions. HISORP® CC can be applied to pre- and post-combustion carbon capture for a variety of emissions sources. The technology is flexible in terms of scale, covering all relevant industrial sizes, CO<sub>2</sub> feed concentration, CO<sub>2</sub> export product state (gaseous, liquid, or supercritical form), and all purity levels, from industrial and sequestration grade to high-purity food & beverage grade.

Typical applications of HISORP® CC include blue hydrogen production; removal of CO<sub>2</sub> from CO<sub>2</sub>-rich flue gases from cement, lime, or steel production; and CO<sub>2</sub> removal from sour gas sources.

## BENEFITS

- All major process units within the HISORP® CC Toolbox have been built by Linde for decades, making it a mature and well-referenced carbon capture technology
- Design is based on maximised modularisation with pre-manufacturing and workshop testing to minimise transportation and installation costs
- 100% driven by electrical power with no steam required unless beneficial for rotating equipment driver selection
- Flexible cooling design minimises fresh water consumption
- An optimised cryogenic purification design requires no external refrigeration to produce gaseous CO<sub>2</sub>
- No consumption, handling, makeup, or emission of chemical washing agents nor disposal of their degradation products results in minimised OPEX for consumables and a lower environmental impact

## KEY PROJECT

Equinor and Linde have started front-end engineering design (FEED) for their joint H2M Eemshaven low-carbon hydrogen project in the Netherlands. Equinor will procure carbon transport and storage capacity and provide low-carbon hydrogen to the market, while Linde will build, co-own, and manage the facilities for hydrogen production using natural gas from the Norwegian continental shelf with CO<sub>2</sub> capture and storage. In excess of 95% of the CO<sub>2</sub> captured will be safely and permanently stored beneath the Norwegian offshore seabed. The objective is to construct a facility in the Eemshaven industrial area capable of producing low carbon hydrogen by 2029 with onshore hydrogen pipelines set to be commissioned in both the Netherlands and Germany.

## KEY DATA

TRL	9	Capture Rate Range (tpd)	100 - >10,000	Modular (Y/N)	Yes
Source CO <sub>2</sub> Purity Range	>10 mol%	Energy Consumption (kWh(e)/tCO <sub>2</sub> )	180 - 400	Capture Efficiency (%)	>95%
Number of Commercial Plants	~	Number of Pilot Plants	~		
Target Industries	Cement & lime, hydrogen, oil & gas, (petro-)chemical, iron & steel				

## TECHNOLOGY DESCRIPTION

### HISORP® CC – CO<sub>2</sub> CAPTURE FOR BLUE HYDROGEN PRODUCTION

The toolbox approach of HISORP® CC shows its advantages for the production of blue hydrogen with steam-methane reforming (SMR), autothermal reforming (ATR), partial oxidation (POX), or gasification. By optimally combining pressure-swing-adsorption (PSA), temperature-swing-adsorption (TSA), HISELECT® membranes, compression, and cryogenic purification, hydrogen recovery is maximised with minimal carbon intensity. HISORP® CC can be retrofitted to existing SMRs and ATRs and applied in the syngas or the tail gas route of the H<sub>2</sub> PSA. Alternatively, for new-built ATR and POX reactors, HISORP® CC is used for carbon capture in the tail gas route, providing reliability and availability, and enhancing H<sub>2</sub> production while reducing specific energy consumption for CO<sub>2</sub> removal.

#### Highlights

- Linde's in-house technologies are combined for blue hydrogen production, including PSA, TSA, HISELECT® membranes, and cryogenic purification
- Individual concepts for different feed streams in hydrogen production plants
- Flexibility in size and scale, ranging from 100 to more than 10,000 tpd CO<sub>2</sub>
- CO<sub>2</sub> capture rate of more than 99.5% with potential for increased hydrogen production

### HISORP® CC – CO<sub>2</sub> CAPTURE FROM CO<sub>2</sub>-RICH FLUE GASES AND OXYFUEL PROCESSES

A large portion of industrial CO<sub>2</sub> emissions are released through flue gases at atmospheric pressures, often carrying a high CO<sub>2</sub> concentration of more than 15%, making them a perfect fit for HISORP® CC. This is particularly relevant for hard-to-abate CO<sub>2</sub> sources, such as flue gases from cement and lime production, and for flue gases from steel production via the blast furnace or direct reduction route, flue gases of SMR for hydrogen production, and other high-content CO<sub>2</sub> streams from oxyfuel processes. Flue gases often contain a high amount of various trace impurities, such as NO<sub>x</sub>, SO<sub>x</sub>, O<sub>2</sub>, volatile organic compounds, aldehydes, and heavy metals that require special treatment steps. In these applications, HISORP® CC core equipment (PSA, TSA, compression, cryogenic purification) is combined with advanced traces impurity treatment and direct-contact cooling (DCC), and CO<sub>2</sub> is captured and purified in accordance with common CO<sub>2</sub> specifications for sequestration, like Northern Lights or Aramis.

#### Highlights

- Combines Linde's in-house technologies for carbon capture from CO<sub>2</sub>-rich flue gases: tailored and advanced impurity removal steps, PSA, TSA, and cryogenic purification
- Individual HISORP® CC concepts for different flue gas sources with flexibility in size and scale from around 100 to more than 10,000 tpd CO<sub>2</sub>
- CO<sub>2</sub> capture rate ranging from typically 95% up to 98% from CO<sub>2</sub>-rich flue gases and oxyfuel processes
- Includes advanced pre-treatment for trace impurity removal (e.g., NO<sub>x</sub>, SO<sub>x</sub>, heavy metals) from flue gases

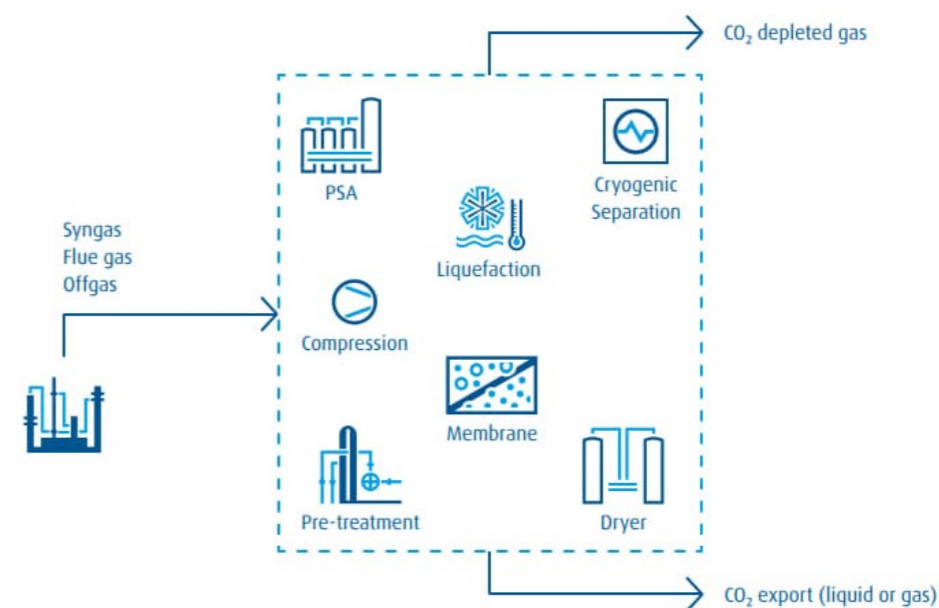

The Linde HISORP® CC toolbox



LINDE

# AMINE WASH PRE-COMBUSTION CO<sub>2</sub> CAPTURE



[ccus@linde.com](mailto:ccus@linde.com)

[www.engineering.linde.com/CO<sub>2</sub>](http://www.engineering.linde.com/CO2)

## SUMMARY

Amine wash processes are the standard for CO<sub>2</sub> removal from steam methane reforming (SMR)-based hydrogen, syngas, and ammonia plants. CO<sub>2</sub> capture from syngas is a proven technology, which achieves a CO<sub>2</sub> recovery rate of 99.9%. Further advantages include a low investment and favorable operating costs. Amine wash units can be installed in various areas of a plant, from low- to high-pressure applications. They are also suitable for advanced CO<sub>2</sub> removal as well as simultaneous removal of CO<sub>2</sub> and sulfur. Amine wash units can also be combined with other Linde technologies, such as the Linde Ammonia Concept (LAC™), or with cryogenic processes for carbon monoxide production.

## BENEFITS

- State-of-the-art process
- Compact design
- Favorable design for low- and high-pressure applications
- Compatible for CO<sub>2</sub> removal and/or sulfur removal

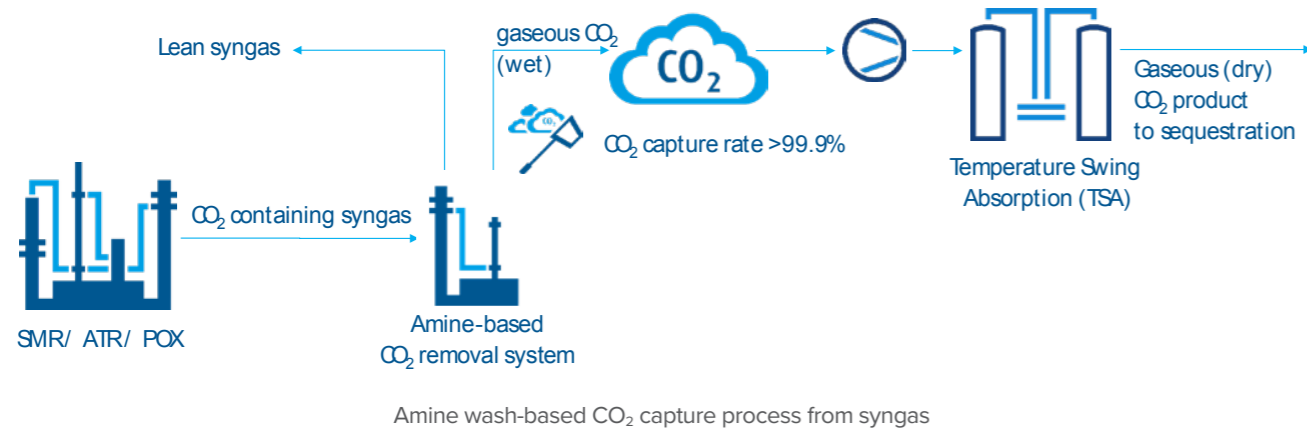

## KEY DATA

TRL	9	Capture Rate Range (tpd)	20 - >2,000	Modular (Y/N)	Yes
Source CO <sub>2</sub> Purity Range	2 - 40%vol	Energy Consumption (GJ/tCO <sub>2</sub> )	1 - 3	Capture Efficiency (%)	99.9%
Number of Commercial Plants	>60	Number of Pilot Plants	~		
Target Industries	Natural gas, oil and gas, chemical				



LINDE

# CO<sub>2</sub> COMPRESSION & DEHYDRATION



[ccus@linde.com](mailto:ccus@linde.com)

[www.engineering.linde.com/CO<sub>2</sub>](http://www.engineering.linde.com/CO2)

## SUMMARY

CO<sub>2</sub> compression and dehydration are the most common process units in all CO<sub>2</sub> plants. If the CO<sub>2</sub> purity already meets specification requirements after the CO<sub>2</sub> capture process, the downstream CO<sub>2</sub> treatment usually involves compression and dehydration. It is also a typical process unit for a CO<sub>2</sub> Processing Unit (CPU) and CO<sub>2</sub> liquefaction plants.

Depending on the plant capacity, different types of compressors can be used, such as piston, screw, and turbo compressors. Depending on local costs for utilities, electrical or steam-driven compressors can be employed.

The targeted CO<sub>2</sub> product pressure is defined by the downstream application or distribution concept. Pressures of up to a maximum of 215 bar have been realised.

Compressor stations not only compress the main CO<sub>2</sub> feed gas stream, but can also be used to integrate and compress boil-off gases from storage tanks and other CO<sub>2</sub>-rich vents from the plant.

## BENEFITS

- Mature and robust technology
- Various options for compressor type
- Multiple references for different scales worldwide

## KEY PROJECTS

- Linde as a CO<sub>2</sub> network owner and major supplier of CO<sub>2</sub> to greenhouses ensures access to the CCS network in the Netherlands for several emitters.

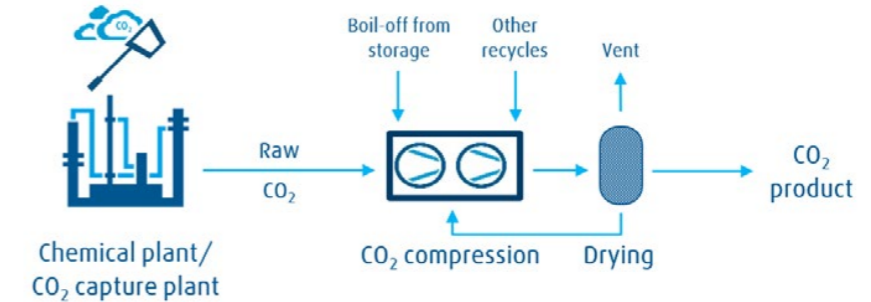

## KEY DATA

TRL	9
-----	---



LINDE

## CO<sub>2</sub> PROCESSING UNIT



[ccus@linde.com](mailto:ccus@linde.com)

[www.engineering.linde.com/CO<sub>2</sub>](http://www.engineering.linde.com/CO2)

### SUMMARY

Linde's CO<sub>2</sub> Processing Unit (CPU) is applied to purify CO<sub>2</sub>-containing gas streams to provide typical CO<sub>2</sub> product specifications for a variety of industrial applications. Typical CPU feed gas streams are CO<sub>2</sub>-rich gases generated from CO<sub>2</sub> capture processes, flue gases from oxy-fuel combustion processes, and CO<sub>2</sub>-rich off-gases from chemical plants, such as ammonia, ethylene oxide, methanol, or ethanol plants. As shown in the figure, an extended toolbox of processes and technologies allows for the removal of different trace components, such as sulphur- or nitrogen-containing compounds, hydrocarbons, heavy metals, and air gases.

Linde initially developed and commercialised the CPU technology to treat oxy-fuel flue gases at an oxy-fuel lignite-fired power plant at Schwarze Pumpe, Germany. More recently, Linde's CPU has been considered for oxy-fuel projects in the cement industry. Mature CO<sub>2</sub> processing technologies in combination with Linde's track record in large-scale gas-treatment plants ensure low-risk EPC projects for clients.

### BENEFITS

- Mature and robust purification technology
- Reference plant in Schwarze Pumpe, Germany, for treatment of oxy-fuel flue gases
- Multiple EPC and Linde operation references for production of food-, chemical-, and electronics-grade CO<sub>2</sub>
- Standardised and skid-mounted modules as well as large-scale customised, stick-built solutions available

### KEY PROJECTS

- Recently, Linde has signed an Engineering, Procurement and Construction (EPC) contract with the CI4C consortium, which is made up of four major European cement producers. The contract is for the construction of the first-ever CO<sub>2</sub> capture and processing plant downstream of an oxyfuel cement process at an existing cement plant in Mergelstetten, Germany.
- Linde, Sabic, and Scientific Design signed a memorandum of understanding (MoU) related to decarbonisation of petrochemical plants. The goal is to establish sustainable chemicals production.

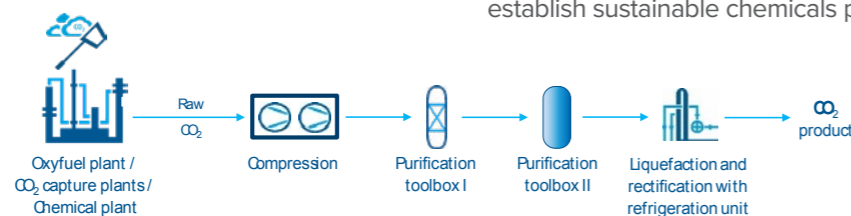

Typical CO<sub>2</sub> Processing Unit (CPU) design

### KEY DATA

TRL	9	Capture Rate Range (tpd)	100 - 12,000	Modular (Y/N)	Yes
Source CO <sub>2</sub> Purity Range	70 - 75%	Energy Consumption (kWh/tCO <sub>2</sub> )	100 - 250	Capture Efficiency (%)	>95 - 99.5%
Number of Commercial Plants	>20	Number of Pilot Plants	2		
Target Industries	Oxyfuel combustion, chemical plants, CO <sub>2</sub> capture facility				



LINDE

## CO<sub>2</sub> LIQUEFACTION



[ccus@linde.com](mailto:ccus@linde.com)

[www.engineering.linde.com/CO<sub>2</sub>](http://www.engineering.linde.com/CO2)

### SUMMARY

CO<sub>2</sub> liquefaction can be an additional process step attached to a CO<sub>2</sub> capture and processing plant. For example, when CO<sub>2</sub> is purified by means of cryogenic separation (rectification), CO<sub>2</sub> liquefaction is involved. In addition, CO<sub>2</sub> liquefaction might be required because of the CO<sub>2</sub> logistics concept when transporting it via road trailers, trains, or ships.

Linde's largest liquefaction plant, in operation since 2015, is producing approximately 1,350 tons of CO<sub>2</sub> per day. The CO<sub>2</sub> is used in enhanced methanol and urea production. Additional large-scale plant references can be found in Norway and the United States for carbon capture and storage (CCS) and food applications, respectively. Depending on local needs, the integration concept, safety considerations, and cost efficiency, different refrigerants can be considered for use in the refrigeration unit.

### BENEFITS

- Mature and robust technology
- Various options for refrigerants available
- Extended reference list at various product capacities
- Standardised and skid-mounted modules as well as large-scale customised, stick-built solutions available

### KEY PROJECTS

- Linde signed a contract with global fertiliser manufacturer Yara to build the world's largest carbon dioxide liquefaction plant in Sluiskil, the Netherlands.

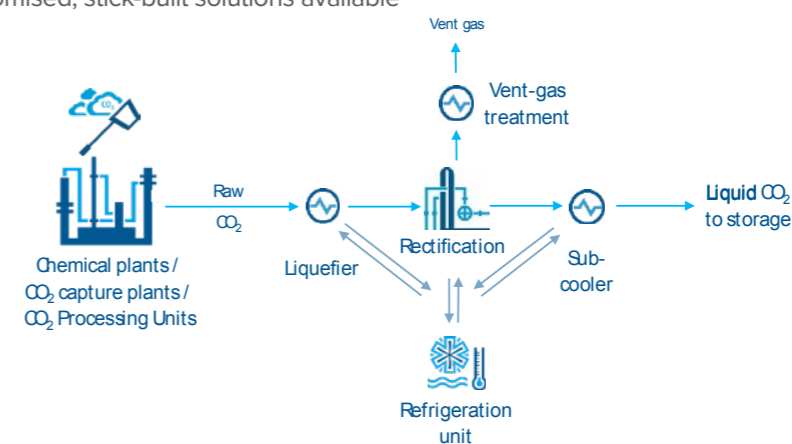

Typical CO<sub>2</sub> liquefaction process design

### KEY DATA

TRL	9
-----	---



# LINDE CO<sub>2</sub> PSA



[ccus@linde.com](mailto:ccus@linde.com)

[www.engineering.linde.com/CO<sub>2</sub>](http://www.engineering.linde.com/CO2)

### SUMMARY

Linde's pressure swing adsorption (PSA) system is an efficient technology for the recovery of CO<sub>2</sub> from process gas streams at a wide concentration range, as shown in the figure below. In many cases, PSA technology is a more cost-effective alternative to conventional washing systems due to its lower investment and operating costs.

In the iron and steel industry, PSA technology can be used to efficiently remove CO<sub>2</sub> in direct reduction or blast furnace off-gases. The process removes maximum amounts of CO<sub>2</sub>, yet leaves valuable gas components, such as H<sub>2</sub>, CO, and CH<sub>4</sub> in the gas stream for further processing. A stand-alone CO<sub>2</sub> PSA unit can achieve a product purity of up to 95 vol%, with unit capacities ranging from a few MMSCFD/thousand Nm<sup>3</sup>/h to around 450 MMSCFD/500,000 Nm<sup>3</sup>/h.

### HIGHLIGHTS

- Mature and robust purification technology
- Negligible electricity consumption
- No steam required for regeneration (thereby no additional CO<sub>2</sub> generation)
- No solvents are applied, so therefore no negative environmental impact due to the emission of solvent traces in exhausts or in the CO<sub>2</sub> product
- No extra cost for solvent makeup and handling
- Low CAPEX and OPEX technology

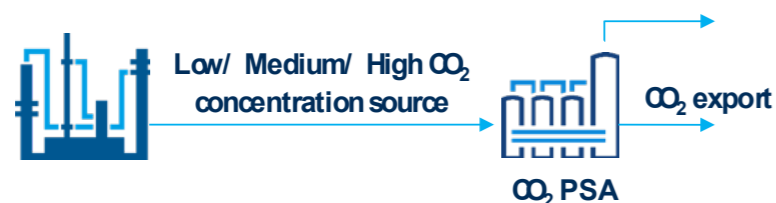

Typical CO<sub>2</sub> PSA process design for efficient capture of CO<sub>2</sub> from process gas

### KEY DATA

TRL	9	Capture Rate Range (tpd)	10 - 5,000	Modular (Y/N)	Yes
Source CO <sub>2</sub> Concentration	>7%	Energy Consumption (GJ/tCO <sub>2</sub> )	0 <sup>1</sup>	Capture Efficiency (%)	99%
Number of Commercial Plants	>15	Number of Pilot Plants	~		
Target Industries	Iron & steel, (petro-)chemical, cement & lime, oil & gas, hydrogen				

<sup>1</sup> If feedgas is at elevated pressure



# LINDE CO<sub>2</sub> TANK FARM AND LOADING STATIONS



[ccus@linde.com](mailto:ccus@linde.com)

[www.engineering.linde.com/CO<sub>2</sub>](http://www.engineering.linde.com/CO2)

### SUMMARY

Linde offers state-of-the-art tank farms to store liquid CO<sub>2</sub>. A range of configurations are available. For example, the storage tanks can be spherical or cylindrical (vertical or horizontal). Tank farms can be equipped with boil-off gas re-liquefaction as well as integration of gas return lines. Moreover, an essential component of a tank farm is a loading station. While most tank farms feature trailer loading stations, Linde has also built train and ship loading stations to cover the whole range of potential distribution concepts.

### HIGHLIGHTS

- Extended reference list at various product capacities
- High degree of standardization and skidded packages to reduce CAPEX
- Advanced sampling and loading system

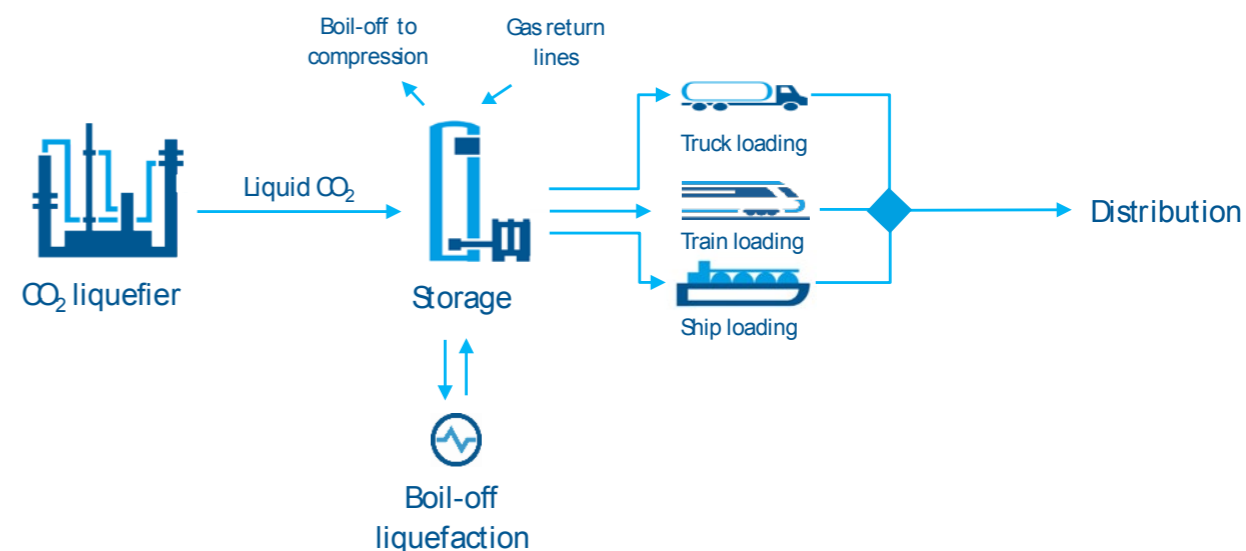

### KEY DATA

TRL	9
-----	---



LINDE

## HISELECT® POWERED BY EVONIK MEMBRANES



[ccus@linde.com](mailto:ccus@linde.com)

[www.engineering.linde.com/CO2](http://www.engineering.linde.com/CO2)

### SUMMARY

The HISELECT® membrane was originally developed with a focus on the natural gas and process gas industries. For natural gas resources with sour and acid fractions, membranes are an excellent alternative to conventional amine wash systems for acid gas removal. Driven by partial pressure difference, the HISELECT® membrane works like a semi-permeable barrier and separates the feed gas into a low-pressure permeate, rich in the gas to be removed or recovered (such as CO<sub>2</sub>) and a high-pressure retentate with a low concentration of these components.

The membranes demonstrate high selectivity for CO<sub>2</sub>, irrespective of high hydrocarbon (HHC) content and CO<sub>2</sub> partial pressure. Additionally, strong resistance to unsaturated hydrocarbons, mechanical robustness, and high resistance to hydrogen sulfide (H<sub>2</sub>S) result in low maintenance requirements. Aside from natural gas sweetening, HISELECT® membrane technology can also be applied in hybrid solutions with pressure-swing or temperature-swing adsorption units to efficiently remove CO<sub>2</sub> or other contaminants.

### HIGHLIGHTS

- Low CAPEX and OPEX with high operational flexibility
- Rapid return on investment
- High separation capacity and high selectivity for maximum recovery rates and high purities
- Ability to tailor membrane capacity and selectivity to customer requirements
- High volume efficiency due to optimised packing of hollow fiber membranes
- Production flexibility with wide feed stream condition range and supporting temperatures up to 212°F/100°C and pressures up to 2,900 PSI/200 bar
- Resistant to CO<sub>2</sub> partial pressure of up to 725 PSI/50 bar
- Robust and stable performance over time under harsh operating conditions, reducing need for overdesign
- Reduced pre-treatment effort due to excellent resistance to heavy hydrocarbons and plasticisation
- Mechanical resistance to process fluctuations during operation

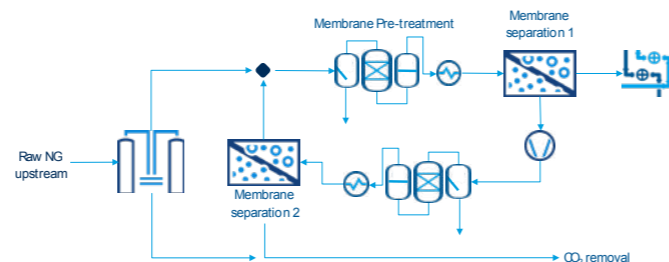

Typical process design of a gas processing unit with HISELECT® for natural gas acid removal.

### KEY DATA

TRL	9	Capture Rate Range (tpd)	>10	Modular (Y/N)	Yes
Source CO <sub>2</sub> Concentration	>2%	Energy Consumption (GJ/tCO <sub>2</sub> )	0 <sup>1</sup>	Capture Efficiency (%)	85 - 95%
Number of Commercial Plants	>20	Number of Pilot Plants	~		
Target Industries	Natural gas				

<sup>1</sup> If feedgas is at elevated pressure



LINDE

## RECTISOL WASH UNIT



[ccus@linde.com](mailto:ccus@linde.com)

[www.engineering.linde.com/CO2](http://www.engineering.linde.com/CO2)

### SUMMARY

Linde's Rectisol wash unit is able to extract sour gas from syngas. The technology has been proven over decades and is adjustable to the actual needs and requirements of plant operators. The process can handle feed gases from different sources and adjust the CO<sub>2</sub> purity in the treated gas with respect to requirements from downstream units. Rectisol technology is used for selective removal of CO<sub>2</sub> and sulphur. The process can be designed for CO<sub>2</sub> capture, where about 99% of the incoming CO<sub>2</sub> can be captured sulfur and water free. The sulphur is enriched in the acid gas fraction, which can, for example, be routed to a sulphur recovery unit (SRU). Linde's Rectisol Wash Unit can be integrated with other Linde gas processing technologies, e.g. downstream cryogenic processes (e.g. CO production), the Linde Ammonia Concept LAC™, or with PSA units.

### HIGHLIGHTS

- State-of-the-art process
- Used for the treatment of feed-gases containing sulphur and CO<sub>2</sub>
- Treated syngas (sulfur < 0.1 vppm, CO<sub>2</sub> adjusted, water free)
- Water- and sulphur-free CO<sub>2</sub> product for further processing
- Capacities from small-scale plants (30,000 Nm<sup>3</sup>/h feed gas) up to high one-train capacity plants (2,000,000 Nm<sup>3</sup>/h feed gas)
- Application pressure from 20 up to 80 bar and higher
- Easy solvent handling (chemically stable, low cost, and readily available on the market)
- Enhanced trace component handling
- Low product losses (H<sub>2</sub> and CO)
- The sulphur-rich tail gas from the SRU can be desulfurised within the Rectisol Wash Unit without the need of an additional wash system and additional equipment

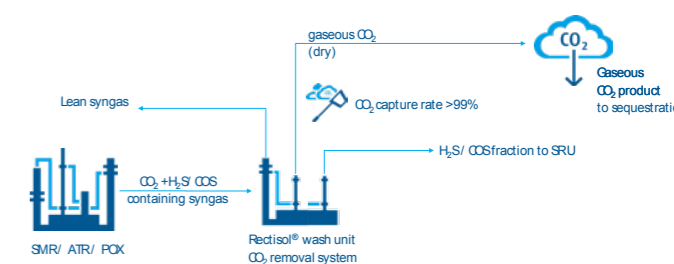

Typical Rectisol process design for CO<sub>2</sub> capture from syngas

### KEY DATA

TRL	9	Capture Rate Range (tpd)	~	Modular (Y/N)	No
Source CO <sub>2</sub> Concentration	High	Energy Consumption (GJ/tCO <sub>2</sub> )	~	Capture Efficiency (%)	~99%
Number of Commercial Plants	~100	Number of Pilot Plants	~		
Target Industries	Syngas				



[www.netpower.com](http://www.netpower.com)

### SUMMARY

NET Power looks to deliver the “energy trifecta” of clean, reliable, and affordable energy using natural gas. NET Power’s technology combines oxy-combustion and a supercritical CO<sub>2</sub> (sCO<sub>2</sub>) power cycle to deliver on-demand natural gas power while capturing nearly all emissions. At scale, this technology can catalyse the decarbonisation of the electric system by providing ultra-low emission dispatchable power to help integrate variable renewable resources.

NET Power’s momentum is built on more than a decade of milestones, including key investments, construction and testing of a 50 MWth demonstration facility, and the ongoing development of its first commercial facility in West Texas known as “Project Permian.” During that time, the company also established long-term partnerships with key process equipment suppliers to support the development of Project Permian and product commercialisation. NET Power continues to secure such supply agreements as it builds out its supply chain network to enable rapid deployment of future plants

### BENEFITS

- **Deliver Clean Power:** NET Power plants are designed to capture CO<sub>2</sub> at unit rates >97% across the operating spectrum.
- **Support Reliable Operations:** NET Power provides 24/7 dispatchable, baseload power with rapid ramp rates and low turn-down capabilities.
- **Produce Affordable Energy:** NET Power plants generate clean power from abundant, low-cost natural gas.
- **Utilise Existing Infrastructure:** NET Power plants can leverage existing pipeline and electricity transmission networks for planning and operations.
- **Scalable:** NET Power is creating a standard plant enabling rapid deployment through modularization modularisation and the ability to stack plants together.
- **Harness the Value of Carbon:** The NET Power Cycle inherently captures high-purity, pressurised CO<sub>2</sub> for sequestration or utilisation, pressurised CO<sub>2</sub> for sequestration or utilisation.

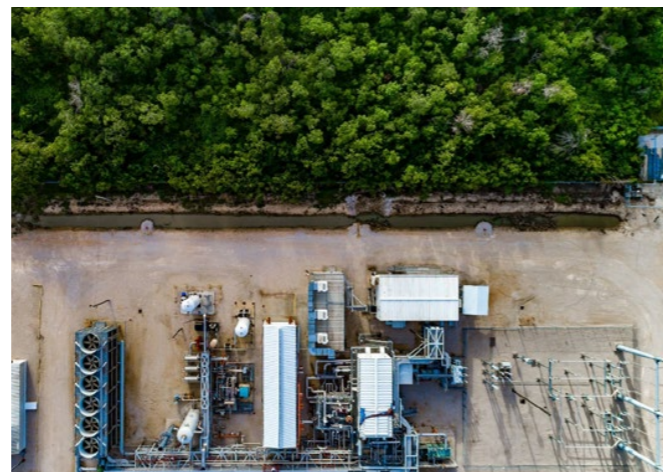

NET Power's La Porte Demonstration Facility

### KEY DATA

TRL	>5	Capture Rate Range (tpd)	~	Modular (Y/N)	~
Source CO <sub>2</sub> Purity Range	~	Energy Consumption (GJ/tCO <sub>2</sub> )	~	Capture Efficiency (%)	~
Number of Commercial Plants	1	Number of Pilot Plants	1	Target Generation Capacity	250 MW
Target Industries	~				

### TECHNOLOGY DESCRIPTION

#### TECHNOLOGY DEVELOPMENT

NET Power has developed its technology during more than a decade of research, development, and operational demonstration. From the beginning, the NET Power Cycle was designed to overcome the challenges faced by both conventional and renewable energy technologies pursuing grid-scale decarbonisation. It solves the energy “trilemma” by providing clean, reliable, and affordable power using abundant and low-cost natural gas.

NET Power utility-scale projects are targeting a net electric output of 200 - 300 MW of clean, dispatchable energy alongside approximately 800 - 900 Mtpa of high-pressure, high-purity CO<sub>2</sub>. Electricity output is designed to have competitive ramping with full carbon capture across the operating spectrum. Meanwhile, criteria pollutants are avoided, and CO<sub>2</sub> emissions are inherently captured.

#### LA PORTE TEST FACILITY

To demonstrate the NET Power Cycle, the company designed and built a demonstration facility in La Porte, Texas. The facility, commissioned in 2018, covers five acres and performed over 1,500 operational hours through October 2022.

The testing included start-up, shutdown, and transient/excursion tests at key operating points. This involved building CO<sub>2</sub> inventory, shedding CO<sub>2</sub> inventory, verification of process chemistry, validation of control and safety systems, operations of pumps and compressors, and testing of process stability and controllability. The facility has also successfully exceeded numerous utility-scale plant specifications, including turboexpander inlet temperature and balance of plant operating pressures. In late 2021, the facility achieved synchronisation with the ERCOT grid.

#### KEY TECHNICAL PARTNERS

NET Power is creating the ecosystem of technology partners across the supply chain to scale up future deployments. NET Power established a Joint Development Agreement with Baker Hughes (turbomachinery, pumps, compressors), a strategic supply agreement with Lummus Technology (heat exchanger), and selected an ASU provider for Project Permian with the intention of announcing a long-term ASU partnership in 2024. NET Power selected Zachry Group perform the FEED study for the first utility-scale plant. Zachry Group is the first EPC Partner licensed by NET Power. This suite of partnerships enables NET Power to develop not only the first utility-scale project, but also to create the basis for a standardised plant design for future plants.

#### NEXT STEPS

In November 2022, NET Power announced that its first utility-scale plant, Project Permian, will be built in West Texas. The plant will seek to capture CO<sub>2</sub> at unit-wide rates above 97% and utilise both currently operating CO<sub>2</sub> transport and subsurface infrastructure to store captured CO<sub>2</sub>. NET Power has begun the interconnection process with ERCOT and is on track for first fire between 2H 2027 and 1H 2028. NET Power has also announced its first originated project in the MISO region. The successful deployment of NET Power's first utility-scale plant will pave the way for other commercial projects, including those already in development.

NET Power is uniquely positioned to deliver the energy trifecta of clean, reliable, and affordable electricity and has established the partnerships and pathways to deliver on this mission. NET Power has successfully demonstrated its technology at the 50 MWth scale and will soon deliver its first utility-scale facility. The company, along with its commercial and technical partners, are accelerating the energy transition and the CCUS market.

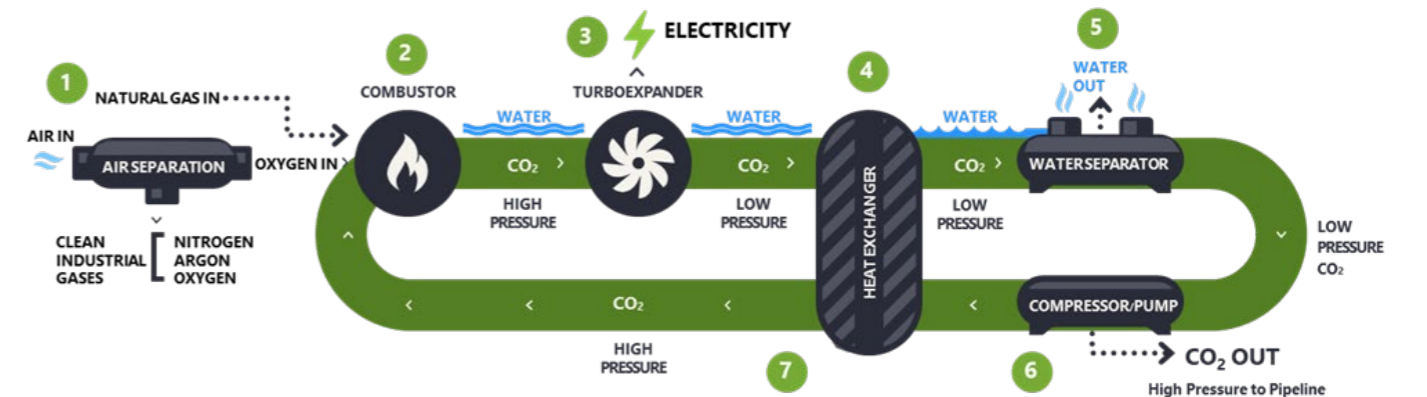

#### Cautionary Note Regarding Forward-Looking Statements and Projections

Certain statements in this report may constitute “forward-looking statements” within the meaning of Section 27A of the Securities Act of 1933, Section 21E of the Securities Exchange Act of 1934 and the Private Securities Litigation Reform Act of 1995, each as amended. Words such as “believes,” “expects,” “intends,” or other similar expressions may identify forward-looking statements. Forward-looking statements involve known and unknown risks, uncertainties and other factors. These factors, risks and uncertainties include, but are not limited to, those described under the headings “Risk Factors” and “Cautionary Note Regarding Forward-Looking Statements” in the Company’s Annual Report on Form 10-K for the year ended December 31, 2023 and in its other filings made with the SEC from time to time, which are available via the SEC’s website. Forward-looking statements speak only as of the date they are made. Readers are cautioned not to put undue reliance on forward-looking statements, and NET Power assumes no obligation and does not intend to update or revise these forward-looking statements. NET Power does not give any assurance that it will achieve its expectations.

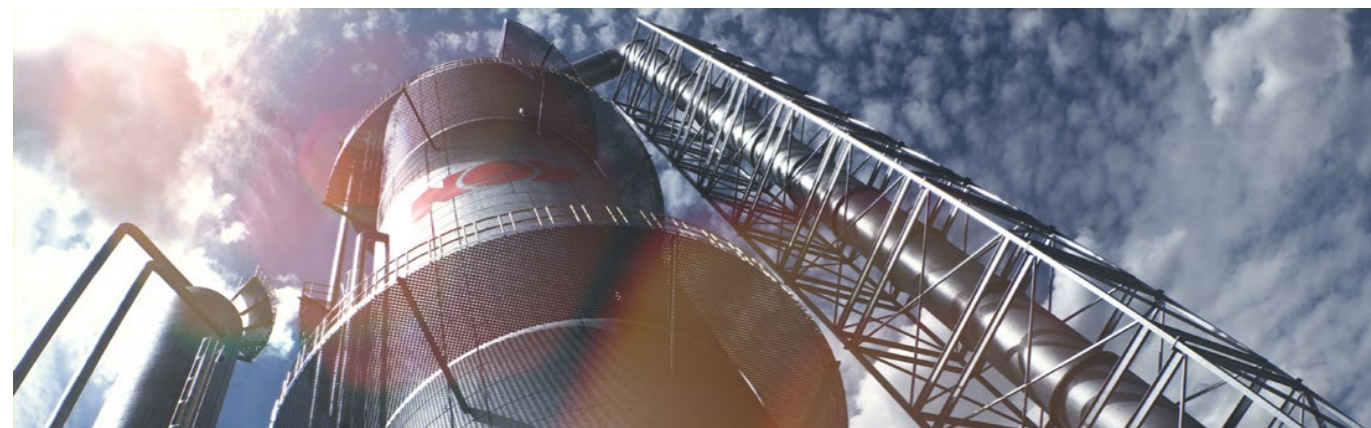

[corporatemarketing@nov.com](mailto:corporatemarketing@nov.com)

[www.nov.com/ccs](http://www.nov.com/ccs)

**SUMMARY**

Carbon capture, utilisation, and storage (CCUS) is essential for meeting emission targets, allowing industries to continue vital processes with reduced environmental impact. Safety in CO<sub>2</sub> handling during transportation and storage is critical. We enhance and re-purpose oil and gas technology and expertise for the energy transition. NOV supports carbon capture projects with technologies like CO<sub>2</sub> conditioning and fiberglass ducting for flue gas gathering, ensuring optimal capture and corrosion protection. We help our customers to select the best capture technology and verify CO<sub>2</sub> volumes for carbon offset and tax credit reporting.

NOV's Process Systems group provides leading technologies for oil, gas, and water treatment. With decades of global expertise, we design and execute custom carbon capture and CO<sub>2</sub> conditioning systems. As your corrosion protection partner, we offer flexibility and optimal project economics through our global presence and experience.

**BENEFITS**

We are a one-stop shop, offering capabilities to support throughout the entire value chain. These benefits include:

- Established execution and global supply chain models featuring local, low-cost fabrication and decreased delivery times
- Experience in standardised systems and equipment packages to drive efficiency
- Precision with large-scale projects mitigates risk and lowers costs associated with engineering design and project management
- Research and development activity to keep customers involved with the latest CCUS technology advancements



**KEY DATA**

TRL	9	Capture Rate Range (tpd)	68 - 2,700	Modular (Y/N)	Yes
Source CO <sub>2</sub> Purity Range	4-25%+	Energy Consumption (GJ/tCO <sub>2</sub> )	~	Capture Efficiency (%)	90 - 95%
Number of Commercial Plants	~	Number of Pilot Plants	~		
Target Industries	All CCUS applications				

**TECHNOLOGY DESCRIPTION**

Our post combustion carbon capture portfolio offerings vary from fully customisable and bespoke solutions, providing a wide range of design flexibility for demanding applications, to a more standard modular offering, reducing the amount of stick build required on-site to enable faster deployment of carbon capture. We offer proprietary amine-based solvent carbon capture technology for post combustion applications. Other solvents can be assessed for use based on client needs.

The following product offerings provide carbon capture systems tailored for efficient application of size and flexibility.

**POST-COMBUSTION CAPTURE PRODUCT OFFERINGS**

**Summit Solution™ Offering**



Our Summit Solution provides a full range of design flexibility to meet demanding applications with CO<sub>2</sub> emissions of up to 1 Mtpa utilising solvent-based technology. This offering allows for full integration to maximize the existing capacity of support systems and reduce operating costs. Furthermore, the footprint and orientation of equipment can be specifically designed to meet more challenging settings.

**Peak Solution™ Offering**



Our Peak Solution provides a limited range of design flexibility to decrease project time and cost. This offering allows for product size ranges to match site requirements and provides flexibility to integrate with existing plant utilities and support systems.

It's tailored to applications ranging from 50,000 - 200,000 ktpa of CO<sub>2</sub> emissions utilising solvent-based technology. Additionally, the footprint and orientation of equipment can be specifically designed to meet site requirements.

**Ascent Solution™ Offering**



Our Ascent Solution uses standardisation and technologies best suited to client needs. The offering utilises a proprietary amine-based solvent carbon capture technology for post combustion applications to meet gas capacities between 25 and 70 ktpa of CO<sub>2</sub>. This set of standardised solutions can fit site needs while decreasing project time and cost.





# TEMPERATURE SWING ADSORPTION (TSA) GAS DEHYDRATION



[corporatemarketing@nov.com](mailto:corporatemarketing@nov.com)

[www.nov.com/ccus](http://www.nov.com/ccus)

## SUMMARY

Most carbon capture processes produce wet CO<sub>2</sub> gas streams that must be dehydrated to meet transportation and storage standards. Dehydration removes water vapour, preventing the formation of corrosive carbonic acid, which can damage carbon steel used in pipelines, pump stations, and storage facilities. Strict safety measures in handling and transporting CO<sub>2</sub> are crucial for public confidence and the adoption of CCUS technologies.

Efficient CO<sub>2</sub> dehydration is vital for the safe and effective transport of CO<sub>2</sub> from capture sites to storage locations. Various mature dehydration technologies are available, each with unique advantages and challenges. The choice of technology depends on factors like CO<sub>2</sub> source, operational scale, energy needs, cost, and water content requirements. Different transportation methods (pipeline, truck, rail, ship) have specific water content and gas purity specifications, influencing the selection of the appropriate dehydration technology. Implementing these technologies will enhance CCS project viability.

## BENEFITS

As a leading global provider of CO<sub>2</sub> dehydration technology and equipment, NOV has expertise in deploying CO<sub>2</sub> dehydration systems worldwide. As a corrosion protection partner, we can help you assess which technology best suits any given application to ensure the CO<sub>2</sub> is safe and does not cause corrosion issues downstream. NOV ensures the CO<sub>2</sub> meets pipeline and transport specifications. This safeguards the transport and sequestration infrastructure, thereby increasing the longevity and safety of the project.



## KEY DATA

TRL	9	CO <sub>2</sub> Feed Capacity	10 - 5,000 ktpa	Modular (Y/N)	Yes
Source CO <sub>2</sub> Purity Range	Saturated	Fast Startup Times	Yes		
Number of Commercial Plants	10+	Water Outlet Content	<1 - 50 ppmv		
Target Industries	All CCUS applications				

## TECHNOLOGY DESCRIPTION

### SORBEAD®

BASF Sorbead® technology is a TSA process that involves passing the CO<sub>2</sub> gas stream through a Sorbead® aluminosilicate gel bed, which has a high affinity for water molecules. The Sorbead® system is then regenerated through heat. It offers a relatively low energy, low cost, and simple method for dehydration. The ease of regenerating the Sorbead® bed in a cyclic manner while achieving a low water content in the dried CO<sub>2</sub> makes this process appealing.

Typically, Sorbead® dehydration is recommended for water content specifications of 5 to 50 ppmv.

### MOLECULAR SIEVE

Molecular sieve TSA technology employs zeolite microporous structures, which selectively adsorb water molecules based on size and polarity. The dehydration process involves the adsorption of water molecules onto the surface of the molecular sieve material. Molecular sieve systems are regenerated by using heat to desorb the water molecules. The ease of regenerating the molecular sieve in a cyclic manner while achieving very low water content in the dried CO<sub>2</sub> makes this process an appealing solution for certain applications. Molecular sieve technology can achieve very dry CO<sub>2</sub> gas, which is beyond what is typically required for various means of CO<sub>2</sub> transport. However, it is more expensive than the other technologies. Typically, molecular sieve dehydration is recommended for water content specifications of <1 ppmv.

### INTEGRATED DEOXYGENATION OPTION

The CO<sub>2</sub> streams from a post-combustion carbon capture system usually contain varying levels of oxygen. Most pipeline transport specifications are placing tight control on oxygen concentrations in addition to moisture. The presence of oxygen in CO<sub>2</sub> at certain levels can cause challenges in reservoir formations associated with storage and enhanced oil recovery. Oxygen can react with hydrogen sulfide and elemental sulfur to create corrosion issues downhole. Most storage and utilisation applications require proper control of oxygen levels.

Elevated oxygen in the CO<sub>2</sub> stream must be removed before transport to meet pipeline specifications. NOV's CO<sub>2</sub> deoxygenation process removes oxygen from CO<sub>2</sub> via a catalytic bed with hydrogen. The CO<sub>2</sub> reacts with hydrogen to form a water byproduct. NOV provides integrated deoxygenation and dehydration systems.

### TEMPERATURE SWING ABSORPTION TABLE

Dehydration Technology	Water Content Spec
BASF Sorbead®	5–50 ppmv (options for <5 ppmv)
Molecular Sieve	<1 ppmv





# TRIETHYLENE GLYCOL (TEG) GAS DEHYDRATION



[corporatemarketing@nov.com](mailto:corporatemarketing@nov.com)

[www.nov.com/ccus](http://www.nov.com/ccus)

## SUMMARY

Most carbon capture processes produce wet CO<sub>2</sub> gas streams that must be dehydrated to meet transportation and storage standards. Dehydration removes water vapour, preventing the formation of corrosive carbonic acid, which can damage carbon steel used in pipelines, pump stations, and storage facilities. Strict safety measures in handling and transporting CO<sub>2</sub> are crucial for public confidence and the adoption of CCUS technologies.

Efficient CO<sub>2</sub> dehydration is vital for the safe and effective transport of CO<sub>2</sub> from capture sites to storage locations. Various mature dehydration technologies are available, each with unique advantages and challenges. The choice of technology depends on factors like CO<sub>2</sub> source, operational scale, energy needs, cost, and water content requirements. Different transportation methods (pipeline, truck, rail, ship) have specific water content and gas purity specifications, influencing the selection of the appropriate dehydration technology. Implementing these technologies will enhance CCS project viability.

*This page has been intentionally left blank.*

## BENEFITS

Triethylene glycol (TEG) is an absorption-based gas dehydration method that uses a liquid solvent to selectively absorb water from the CO<sub>2</sub> stream. Known for its high dehydration efficiency, commercial viability, and cost-effectiveness, TEG results in a relatively higher water content level than other dehydration technologies. Typically, TEG is recommended for water specifications down to 50 ppmv.



As a leading global provider of CO<sub>2</sub> dehydration technology and equipment, NOV has expertise in deploying CO<sub>2</sub> dehydration systems worldwide. As a corrosion protection partner, we can help you assess which technology best suits any given application to ensure the CO<sub>2</sub> is safe and does not cause corrosion issues downstream. NOV ensures the CO<sub>2</sub> meets pipeline and transport specifications. This safeguards the transport and sequestration infrastructure, thereby increasing the longevity and safety of the project.

## KEY DATA

TRL	9	CO <sub>2</sub> Feed Capacity	10 - 5,000 ktpa	Modular (Y/N)	Yes <sup>1</sup>
Source CO <sub>2</sub> Purity Range	Saturated	Fast Startup Times	No		
Number of Commercial Plants	100+	Water Outlet Content	50-600 ppmv		
Target Industries	All CCUS applications				

<sup>1</sup> Specific size ranges have the option of modularity



# POST-COMBUSTION CAPTURE FIBERGLASS DUCTING



[fgssales@nov.com](mailto:fgssales@nov.com)

[www.nov.com/fgs](http://www.nov.com/fgs)

## SUMMARY

Corrosion resistance is crucial in carbon capture technology, particularly in the post-combustion capture process, due to the presence of corrosive gases such as carbon dioxide (CO<sub>2</sub>) and other impurities in the flue gas. These gases can lead to the formation of corrosive compounds such as carbonic acid, which can degrade the materials used in the capture equipment, leading to reduced efficiency, increased maintenance costs, and potential safety hazards.

For more than 60 years, NOV's Fiber Glass Systems (FGS) business unit has provided fiberglass duct systems, piping, and tanks in a variety of applications and industries around the world. From the start of the carbon capture processes, our high-temperature fiberglass ducting with capabilities up to 325°F (162°C) can reduce post-combustion capture costs.

## BENEFITS

- **Corrosion and Chemical Resistance:** Flue gas in post-combustion carbon capture processes often contains corrosive compounds such as sulfur dioxide and nitrogen oxides, which can lead to corrosion in costly metallic ducting. Fiberglass ducting, with its high resistance to corrosion, is an excellent choice for maintaining structural integrity and longevity in this environment.
- **Temperature Resistance:** Fiberglass ducting can withstand high temperatures without deforming or degrading.
- **Lightweight and Easy to Install:** The lightweight nature of fiberglass is easier to install than heavy metallic alternatives, contributing to cost-effectiveness and efficient installation.

## KEY PROJECTS

- **American Electric Power (AEP) Mountaineer Station:** In 2009, FGS, in support of Alstom Power, Inc., completed the structural design, fabrication and delivery of one 10-ft diameter x ~77-ft-tall filament-wound FRP scrubbing vessel and over 1,300 linear feet of 48-in. to 60-in. diameter filament-wound FRP ductwork, comprising the integral portion of the world's first demonstration project to capture and store CO<sub>2</sub> from an existing coal-fired power plant.
- **Tomato Greenhouse in Utah:** FGS provided 10-ft diameter insulated ducting to transport CO<sub>2</sub> captured from a Pacific Northwest power plant to an adjacent tomato greenhouse for CO<sub>2</sub> fertilization for crops.
- **North Dakota Coal-Fired Power Plant:** Installed in 2010, FGS designed and manufactured 21-ft diameter ducting from each absorber, joining at a common wye and exiting at 30-ft diameter.

## KEY DATA

TRL

9

## TECHNOLOGY DESCRIPTION

Designing with Fiberglass-Reinforced Plastics (FRP) requires a unique knowledge of composite materials, environmental conditions, chemical properties, ASTM and ASME specifications, and familiarity with specialised fabrication and construction practices. We design and manufacture complete duct systems, including ductwork, hoods, dampers, anchors, hangers, guides, and expansion joints. Cylindrical sizes designed, manufactured, and assembled include duct and components from 4 in. ID to 16 ft ID. We also have the unique capability of designing and manufacturing largescale ductwork systems ranging from 18 ft ID to 48 ft ID, either at your job site or from one of our facilities.

Our proprietary large-diameter winding equipment and highly trained field construction personnel assemble and install fiberglass ducting instead of costly high alloys, providing a long-lasting and corrosion-resistant solution for post-combustion capture.



American Electric Power (AEP) Mountaineer Station

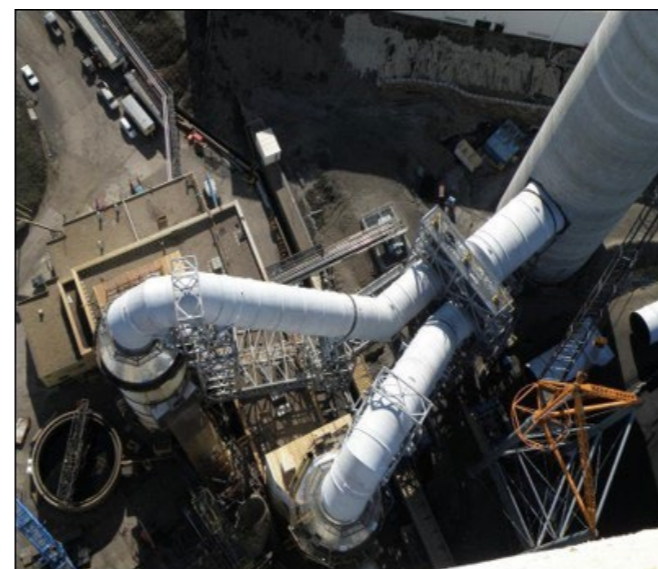

North Dakota Coal-Fired Power Plant

# ENZYMATIC POST-COMBUSTION CARBON CAPTURE



[KLSL@novonesis.com](mailto:KLSL@novonesis.com)

[www.novonesis.com](http://www.novonesis.com)

## SUMMARY

Now you can put the tremendous power of biosolutions to work for more efficient and sustainable carbon removal.

For millions of years, nature has regulated CO<sub>2</sub> using enzymes called carbonic anhydrases. These highly efficient biocatalysts catalyse gaseous CO<sub>2</sub> into water-dissolved bicarbonate, and vice versa. Every enzyme molecule enables 1,000,000 catalytic reactions per second. These reactions run until reaching equilibrium between gaseous CO<sub>2</sub> and dissolved bicarbonate.

Novonesis (the company formed through the combination of Novozymes and Chr. Hansen) and Saipem (see separate listing) have joined forces to deliver carbon capture solutions based on enzyme (biocatalyst) technology. Novonesis is a global company leading the era of biosolutions. Saipem is a carbon capture process and equipment expert with more than 60 years of demonstrated expertise in EPC.

## BENEFITS

### Enzymatic carbon capture is reliable

- Requires less equipment, lowering the risk of potential downtime
- Involves no prototype equipment – everything is built at scale
- Avoids the risk of more stringent regulatory requirements

### Enzymatic carbon capture is efficient

- Yields high purity CO<sub>2</sub> (≥ 99%)
- Can capture > 95% of CO<sub>2</sub> in flue gas
- Runs on less costly, low-grade residual heat
- Involves less equipment to build, operate and maintain
- Higher tolerates flue gas contaminants

### Enzymatic carbon capture is sustainable

- Uses a non-toxic, biodegradable solvent
- Produces no toxic waste and forms no toxic aerosols



## KEY DATA

TRL	8	Capture Rate Range (tpd)	~	Modular (Y/N)	Yes
Source CO <sub>2</sub> Purity Range	~	Energy Consumption (GJ/tCO <sub>2</sub> )	~	Capture Efficiency (%)	>95%
Number of Commercial Plants	1	Number of Pilot Plants	3		
Target Industries	-				

## TECHNOLOGY DESCRIPTION

### BIOSOLUTIONS ARE TRANSFORMING INDUSTRY

Novonesis already helps more than 30 different industries boost efficiency and sustainability with enzyme biosolutions (biological catalysts). Enzymes are proteins found everywhere in nature. When one substance needs to be transformed into another, nature uses enzymes to speed up and control the process.

For example, our industrial enzymes have been enabling low-carbon fuel technologies and sustainable biorefining for decades.

### REPLACE AMINES WITH BIOCATALYSTS

To minimise the risk and maximize the value of carbon capture, forward-thinking businesses are considering replacing toxic amines with biocatalysts.

This proven biosolution, called enzymatic carbon capture, is powerful enough to meet the toughest industrial challenges. And it's sustainable enough to stand up to the toughest scrutiny.

### BIOCATALYSTS BENEFIT YOUR BUSINESS TODAY AND TOMORROW

Enzymatic carbon capture delivers CO<sub>2</sub> absorption capacity and kinetics on par with amine solutions. It has a capture efficiency of above 95% with CO<sub>2</sub> purity of >99%.

Biocatalytic enzyme technology can strip CO<sub>2</sub> at lower temperatures, saving valuable energy. Unlike the amine-based approach, enzymatic carbon capture does not require costly, energy-consuming steam. Instead, it consumes a low level of the plant's energy output, translating into up to 20% lower energy costs if waste heat is available.

You also have less equipment to build, operate and maintain with enzymatic carbon capture and there's no prototype equipment – everything is built at scale, simplifying implementation.

There are no worker health issues to handle and no need to clean the wastewater when replacing solvent with a benign salt solution and biodegradable enzymes. No toxic degradation products or aerosols need handling or cleaning. Operators face fewer risks.

### ONLY NOVONESIS AND SAIPEM CAN DELIVER A BIOSOLUTION THAT STANDS UP TO YOUR TOUGHEST CHALLENGES

The enzymatic carbon capture process is very similar to the established post-combustion process – it simply replaces toxic amines with biocatalytic enzymes. And, it requires less equipment.

The novel catalysed solvent solution offers strong chemical stability, non-toxicity, non-volatility and low-grade temperature regeneration.

The catalyst is an enzyme type used by all living organisms to regulate CO<sub>2</sub>. Called carbonic anhydrase, this biocatalyst is used in the absorber, along with carbonate. When the flue gas passes through the absorber, the enzyme converts the CO<sub>2</sub> to bicarbonate, binding it in the bicarbonate. When the circulating bicarbonate fluid reaches the stripper, it must be heated to only 75°C to release the CO<sub>2</sub> – rather than the 100°C required for amine-based carbon capture.

Our unique partnership combines Novonesis' cutting-edge enzyme expertise with Saipem's unmatched carbon capture processes and equipment know-how. Saipem supplies the carbon capture process and equipment; we supply the enzymes that optimise the process.

We bring our game-changing catalysed solvent technology and world-class project delivery capabilities. Thanks to our global supply chain and technical expertise, we have a track record of delivering reliable solutions to industry for more than 70 years.

### YOU CAN START YOUR CARBON CAPTURE PROJECT NOW

Enzymatic carbon capture offers the same level of maturity (TRL-8) as advanced amine and other second-generation solvents but has much greater potential.

Saipem and Novonesis are offering both "CO<sub>2</sub> Solutions by Saipem" to the market and "Bluenzyme," a standardised, modular turnkey solution that reduces implementation from 3 years to 1.5 years (see Saipem listing for details).

Now you can achieve your decarbonisation goals with operationally and environmentally sustainable technology. Enzymatic carbon capture from Novonesis and Saipem minimises your risks and maximises value.

[CO<sub>2</sub> Solutions | Saipem](#)



 [contact@nuadaCO2.com](mailto:contact@nuadaCO2.com)

 [www.nuadaCO2.com](http://www.nuadaCO2.com)

**SUMMARY**

Nuada is a carbon capture solutions provider poised to decarbonise heavy industries through its next-generation point-source capture technology that redefines carbon capture and addresses the energy, cost, and integrational challenges of conventional solutions. The technology combines advanced solid sorbents, named Metal-Organic Frameworks (MOFs), with mature vacuum pressure swing adsorption (VPSA) technology to separate CO<sub>2</sub> from flue gases, using pressure rather than heat. This combination represents a step change in carbon capture innovation and yields a fully electrified process that slashes the associated energy penalty by up to 80% compared to incumbent solutions. With two first-of-a-kind (FOAK) MOF-based VPSA carbon capture plants piloted at cement and waste-to-energy facilities, Nuada is in a position to fast-track the commercial deployment of its award-winning innovation as a vital energy-efficient and cost-effective solution to decarbonise industry.

**BENEFITS**

- **Ultra-Energy Efficient:** The energy penalty for carbon capture is reduced by up to 80% compared to incumbent solutions.
- **No Complex Integration:** An end-of-pipe and fully electrified solution; no heat or steam required.
- **Wide Applicability:** CO<sub>2</sub> can be recovered from a broad spectrum of point sources and at different scales.
- **Mature Process Technology:** VPSA is a mature, proven and readily scalable separation technology that has been applied for decades at an industrial scale.
- **High-Purity CO<sub>2</sub> Product:** Purity up to 99% without extra purification step; No oxygen or solvent-based impurities in the CO<sub>2</sub> stream.
- **Dynamic Operation:** The rapid capture and release cycles provide flexibility to address operational challenges such as flue gas fluctuations or facilitate quick startups and shutdowns.

**KEY PROJECTS**

- **Nuada Scout at Buzzi Unicem:** Nuada has built and deployed the FOAK MOF-based VPSA carbon capture plant of 1 tpd scale at Buzzi Unicem’s cement plant in Monselice, Italy.
- **UNICORN Project:** Nuada deploys a second pilot plant of 1 tpd scale to be tested in waste-to-energy flue gases at the Translational Energy Research Centre (TERC) in Sheffield, United Kingdom. This project is funded by the CCUS Innovation 2.0 programme from the UK Department for Energy Security and Net Zero (DESNZ).

**KEY DATA**

TRL	6	Capture Rate Range (tpd)	1 - 4,000	Modular (Y/N)	Yes
Source CO <sub>2</sub> Purity Range	>5%	Energy Consumption (GJ/tCO <sub>2</sub> )	0.7	Capture Efficiency (%)	>95%
Number of Commercial Plants	0	Number of Pilot Plants	2	Product CO <sub>2</sub> Purity	Up to 99%
Target Industries	Cement, Lime, Waste-to-Energy, Steel, Oil & Gas, Chemicals				

**TECHNOLOGY DESCRIPTION**

Nuada’s technology is the cultivation of a multi-year innovative work. The company evolved into a vertically integrated carbon capture technology developer with an IP portfolio that covers the full technology package, ranging from the development and manufacturing of proprietary sorbents to the engineering of the MOF-based VPSA process.

Nuada’s patented carbon capture process combines the unique properties of MOFs with mature VPSA technology. MOFs are advanced solid sorbents with an unmatched porosity that can be engineered to selectively capture large volumes of CO<sub>2</sub> from off-gas streams through physical separation, i.e. entrapment of CO<sub>2</sub> molecules within their tailormade porous structure. This selectivity optimises the efficiency and energy use within the capture process. Nuada’s proprietary MOF sorbent materials for efficient point source carbon capture are integral to its patented VPSA carbon capture process.

The incorporation of VPSA technology is what sets Nuada’s approach apart from traditional carbon capture methods that typically rely on thermal processes for regeneration. The weak interaction and the absence of chemical bonds between MOFs and CO<sub>2</sub> molecules minimise the energy input for releasing the captured CO<sub>2</sub>. Nuada engineered a “heatless” process to regenerate the MOF filters by application of a small pressure gradient. This drastically reduces the energy penalty for carbon capture and consequently lowers the cost of capture.

**NUADA’S MOF-BASED VPSA PROCESS**

Nuada’s technology is designed for point-source (in-situ) carbon capture as an end-of-pipe (EoP) solution that can be readily deployed at the back end of industrial processes. The carbon capture units feature a bank of compact adsorption columns filled with highly selective MOF filters. During the carbon capture process, the CO<sub>2</sub>-rich flue gas is first conditioned and then directed to the carbon capture unit where the MOF filters selectively capture the carbon dioxide at super-atmospheric pressure and temperature. Once the MOF filters are suitably saturated, they are regenerated by the application of vacuum and release the captured CO<sub>2</sub> into a high-purity stream, ready for downstream operations. During this regeneration step, the CO<sub>2</sub>-rich feed gas is diverted to another parallel column, yielding a continuous removal process. Both adsorption and desorption cycles are rapid, lasting only a few minutes.

**Emitter Agnostic & Flexible**

This vacuum filtration system provides the flexibility to recover CO<sub>2</sub> from a broad spectrum of point sources and at different scales, thanks to Nuada’s highly selective MOF filters and the modular nature of the VPSA process. Nuada’s carbon capture units are powered solely by electricity which enables seamless energy integration to any facility but also an opportunity to reduce further the site’s carbon intensity using renewable electricity. In addition, the combination of the high-capacity MOF filters with the rapid capture and release cycles and the modular VPSA process yields compact, low-footprint solutions that enable retrofitting into sites with limited availability of space.

**An Award-Winning Innovation**

Nuada’s cutting-edge technology is recognised as a pivotal innovation in the carbon capture domain by various stakeholders including funding bodies, industrial associations, networks, media, and emitters. The technology is backed by the Global Cement and Concrete Association (GCCA) and leading cement producers. After being selected as one of six technologies from over 100 global entrants in the GCCA’s Innovandi Open Challenge 2022, Nuada Partnered with leading cement producers such as Buzzi Unicem, Cementir Holding, Heidelberg Materials, Holcim, Siam Cement Group, Cementos Argos and Cementos Molins to deploy the technology as a cornerstone solution for low-carbon cement. Furthermore, the technology has been recognised as a disruptive CCUS innovation through grant awards by Innovate UK and the UK DESNZ. Nuada’s innovation has received awards and accolades from prominent organisations such as the Institution of Chemical Engineers (IChemE), Decarb Connect, Carbon Capture Canada, Reuters Events and Business Green.

**CAPTURING THE FUTURE**

Following three years of successful bench-scale testing, Nuada brought this technology into the field and built the first-of-a-kind MOF-based VPSA plants (1 tonne of CO<sub>2</sub> capture per day) to showcase the technology’s performance in industrial facilities. The first trials began at Buzzi Unicem’s cement plant in Monselice (Italy) in Q2 2024 while the technology is also piloted in waste-to-energy flue gas streams at the Translational Energy Research Centre (TERC) in Sheffield (UK). These pilots showcase the excellent capture efficiency, game-changing energy benefits and applicability of the MOF-based VPSA process in variable point sources. Nuada is advancing the technology readiness level (TRL) of the innovative MOF-VPSA combination by planning the deployment of a larger demonstration plant, aimed at proving the technical and commercial scalability of the technology. Unlike other emerging technologies, the know-how, manufacturing capabilities and supply chains already exist to enable rapid large-scale deployment, as the individual components of the technology stand at a high TRL. Nuada has scaled up the in-house production of its proprietary sorbents, with an existing capacity to manufacture multi-tonne quantities. The maturity and scalability of the VPSA technology are already proven in other applications, ensuring the reliability and potential for wide-scale deployment of Nuada’s technology.



✉ [khairul\\_rostani@petronas.com](mailto:khairul_rostani@petronas.com)

✉ [nanthini.raman@petronas.com](mailto:nanthini.raman@petronas.com)

## SUMMARY

### A KEY TO ACHIEVING NET ZERO TARGETS

PETRONAS, pioneering as the first Oil and Gas company in Southeast Asia to commit to net zero emissions by 2050, introduces a groundbreaking solution in carbon capture technology: the Membrane Contactor (MBC). This fully modularised technology seamlessly integrates the strength of solvent-based absorption with the adaptability of membranes. MBC's innovative design boasts a revolutionary 50% reduction in overall volume, previously deemed unattainable in carbon capture technology. More than just its size, the MBC signifies impact, offering new avenues for industries tackling decarbonisation challenges, particularly in hard-to-abate sectors. With its compact and flexible nature, MBC empowers companies to scale their carbon capture efforts in line with their decarbonisation ambitions. Implementation is no longer synonymous with daunting infrastructure projects; MBC's swift setup and minimal operational disruption makes carbon capture not only feasible but also accessible, and remarkably cost-effective for the industries.

## BENEFITS

- **Minimises Overall Carbon Footprint:** MBC's state-of-the-art multi-cartridge membrane contactor modules, achieve an impressive 50% reduction in the overall volume while maintaining high carbon capture efficiency, all within a compact design.
- **Tailored Solutions for Every Need:** MBC offers unparalleled scalability, allowing seamless adjustments to match the unique requirements of our clients. MBC adaptable nature ensures flexibility by catering to clients' evolving operational needs.
- **Competitive Cost to Capture:** Lower compression cost due to high regeneration pressure up to 5 barg, and lower solvent circulation rate up to 30%, as first of its kind modular technology. Aimed at achieving CO<sub>2</sub> capture for a competitive cost of US\$30-50 per tonne, MBC ensures maximum value for every investment.
- **Confronting Challenges with Innovation:** By segregating the solvent and gas phases, MBC effectively mitigates

foaming issues, minimising the need for anti-foam agents. By having a differential pressure control system, this not only cuts operational costs but also extends membrane lifespan, guaranteeing sustained performance over time.

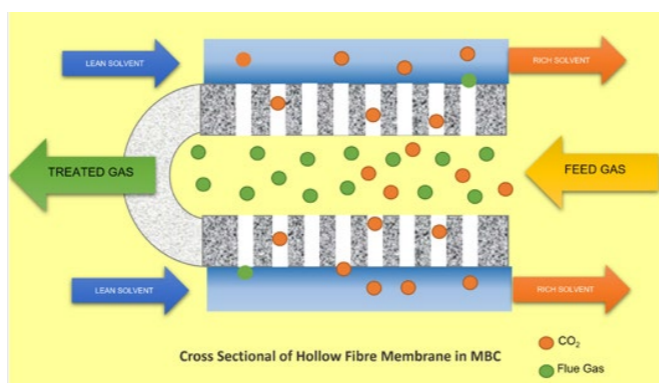

Figure 1: Cross Sectional of Hollow Fibre Membrane in MBC

## KEY DATA

TRL	5	Capture Rate Range (tpd)	10 - 600	Modular (Y/N)	Yes
Source CO <sub>2</sub> Purity Range	3 - 30%	Energy Consumption (GJ/tCO <sub>2</sub> )	<2.9	Capture Efficiency (%)	>95%
Number of Commercial Plants	~	Number of Pilot Plants	4	Pressure Drop	<0.2bar
Target Industries	Refineries, Hard-to-abate industries (Cement, Steel, Chemicals and Power & Gas Plants)				

## TECHNOLOGY DESCRIPTION

Carbon Capture and Storage (CCS) technology plays a critical role in combating climate change. Despite its potential benefits, the widespread adoption of CCS faces several challenges. Traditional CCS systems often require significant space for installation, posing issues for industries with limited land or optimised facilities. Integrating large-scale CCS systems into existing industrial sites can be costly and disruptive, making it a less attractive option for many businesses.

PETRONAS and its groundbreaking Membrane Contactor technology is poised to revolutionise the CCS landscape. With a remarkable >20-fold increase in mass transfer area compared to conventional systems, this innovation delivers unparalleled efficiency. This enhancement results in a compact and efficient separation system boasting a remarkable 75% reduction in height, 40% reduction in weight, and impressive cuts of 25% in solvent usage. Going beyond its impressive physical characteristics, PETRONAS' modular technology offers scalability and operational simplicity, effectively addressing common challenges like flooding and foaming.

Its versatility, demonstrated by its compatibility with a diverse range of solvents, ensures adaptability to meet the unique needs of various markets. PETRONAS and Dalian Institute of Chemical Physics (DICP) has taken innovation a step further by enhancing the CO<sub>2</sub> separation performance, boasting superior absorption capabilities, which has a capture efficiency of more than 95%. This breakthrough results in reduced solvent usage and a 25% decrease in regeneration energy consumption, compared to conventional amine packed bed column system.

PETRONAS' proprietary technology incorporates a suite of design enhancements aimed at driving down the cost of CO<sub>2</sub> capture. From shorter MBC columns to streamlined solvent circulation and integrated inter-cooler heat exchanger designs, every aspect is meticulously crafted for maximum efficiency and cost-effectiveness.

In a landscape where sustainability and economic viability are non-negotiable imperatives, PETRONAS leads the change with transformative CCS solutions, setting new benchmarks for environmental responsibility and commercial excellence.

## PROCESS DESCRIPTION

The process starts with a conditioning step of the flue gas from the point source emission (3-30% CO<sub>2</sub>), whereby the flue gas is cooled down to between 40°C and 60°C via a combination of Waste Heat Recovery Unit (WHRU) and Direct Contact Cooling (DCC) if available where SO<sub>x</sub>, NO<sub>x</sub> and fine particulates are removed.

After cooling, the absorption of CO<sub>2</sub> from the cooled flue gas takes place in the MBC absorber where this gas stream is in contact with the semi-lean amine solvent. Gas flows into the membrane tube side counter-current with semi-lean solvent which is fed into the shell side of the MBC absorption module.

The counter current flow configuration enables the leanest solvent to come into contact with flue gas near the gas exit of the module, maintaining high CO<sub>2</sub> concentration gradient between the flue gas and solvent throughout the module, which is translated into better CO<sub>2</sub> removal efficiency.

The depleted gas is released to the atmosphere; while the CO<sub>2</sub> rich amine is heated and sent to the MBC regenerator. Additional heat is added in the reboiler to favour the release of the absorbed CO<sub>2</sub>. Two streams leave the desorber: the CO<sub>2</sub> rich gas stream which can either be sequestered to storage or utilised to a higher value product, and the semi-lean amine. The semi-lean amine is then recycled back into the MBC absorber. The CO<sub>2</sub> recovered has purity more than 98%.

The flow rate of the feed gas, and the solvent can be varied independently depending on the process conditions and requirements, providing the system with higher flexibility for any changes in process inputs as compared to the conventional tall absorption columns.

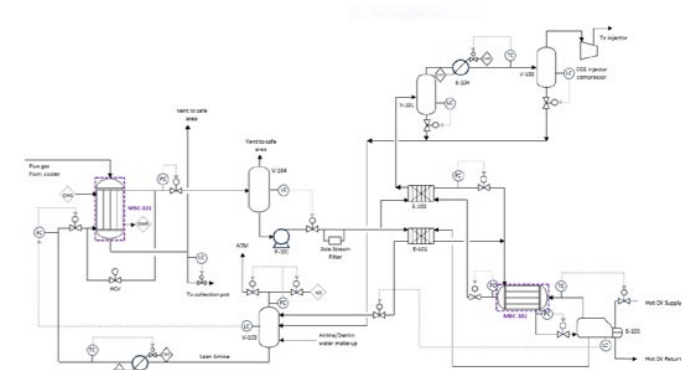

Figure 2: PETRONAS MBC Flue Gas Process Flow Diagram

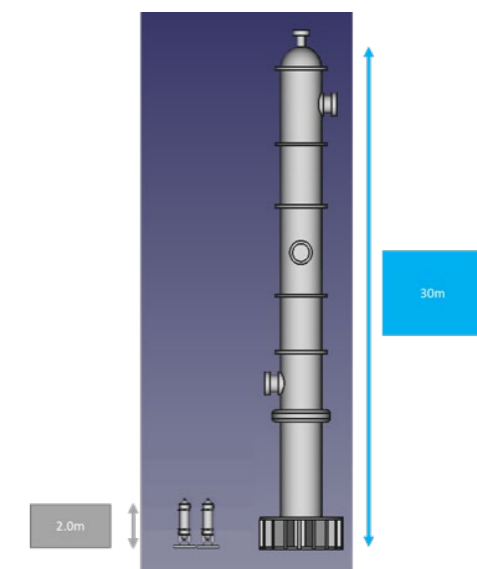

Figure 3: MBC Comparison with the Conventional Column Height

## PROOF POINT: PETRONAS'S CARBON CAPTURE DEMO PROJECT.

MBC Capture technology will be deployed for Carbon Capture demonstration project at one of PETRONAS's facilities, with a capacity of 10 TPD, a significant stride towards embracing low-carbon solutions. By leveraging MBC technology, PETRONAS aims to achieve substantial cost reductions in its capture processes, with anticipated equipment savings of 27% and energy cost savings of 30%. This strategic initiative highlights PETRONAS' dedication to environmental sustainability, prioritising emission reduction at its core operations.



[info@CO2solutions.com](mailto:info@CO2solutions.com)

[www.saipem.com/](http://www.saipem.com/)

## SUMMARY

In an era where sustainable technological solutions are paramount, Saipem's CO2 Solutions emerges as a beacon of innovation. Our enzymatic carbon capture technology, pioneered through decades of research and development, offers a superior approach to mitigating industrial CO<sub>2</sub> emissions. This technology is designed to be both environmentally friendly and economically viable, aligned with Saipem's commitment to advancing the global transition towards a greener future. By harnessing the power of nature with cutting-edge engineering, we provide a scalable, effective solution for industries striving to achieve their carbon neutrality goals.

## BENEFITS

- **Environmentally Friendly:** Utilises a non-toxic, non-volatile carbonate solvent, minimising ecological impact.
- **Cost-Efficiency:** Reduces operational costs through low-grade heat for solvent regeneration and a simplified process that lowers CAPEX and OPEX.
- **Operational Simplicity:** A streamlined process requiring fewer pieces of equipment enhances usability and maintenance.
- **High Tolerance:** The solvent is inert to SO<sub>x</sub> and NO<sub>x</sub>, offering superior resistance and more flexibility in various industrial environments.
- **Risk Mitigation:** Eliminates many hazards associated with traditional carbon capture methods, providing a safer, more reliable solution.

## KEY PROJECTS

- **St-Félicien Facility, Quebec, Canada** (Since 2019 - Ongoing): Successfully tested commercial scale enzymatic carbon capture from lime kiln exhaust, capturing over 95% CO<sub>2</sub> at 30 tpd. Now in commercial operations.
- **The ACCSESS Project, EU's Horizon 2020** (since 2022 - ongoing): Advancing novel high-intensity contactors to TRL7 in Norway, Sweden, and Poland, offering cost-effective solutions.
- **Parachem Industrial Demonstration, Quebec, Canada** (2017-2019): Showcased enzymatic carbon capture in chemical production, highlighting integration and environmental benefits. Ran over 3,000 hours
- **Valleyfield Pilot Plant, Canada** (2015-2017): Validated the technology at TRL-7, capturing 10 tonnes of CO<sub>2</sub>/day over 2,500 hours.

## KEY DATA

TRL	8	Capture Rate Range (tpd)	200+	Modular (Y/N)	Yes
Source CO <sub>2</sub> Purity Range	5%+	Energy Consumption (GJ/tCO <sub>2</sub> )	2.5 - 3.5*	Capture Efficiency (%)	95%
Number of Commercial Plants	1	Number of Pilot Plants	3		
Target Industries	Suitable to all industries with post-combustion emissions of any kind, especially to sites that have access to low-grade residual or geothermal heat above 85°C.				

\*Hot utility at 85°C (hot water only, no steam required)

## TECHNOLOGY DESCRIPTION

### CO2 SOLUTIONS ENZYMATIC PROCESS TECHNICAL OVERVIEW

CO<sub>2</sub> Solutions by Saipem™ process technology revolutionises carbon capture through enzymatic mechanisms, offering unmatched efficiency and environmental compatibility. This meticulously designed system captures CO<sub>2</sub> with minimal energy input and maximum environmental stewardship and safety.

#### Role of Enzyme in Capture

Carbonic Anhydrase is an efficient and naturally occurring catalyst that converts CO<sub>2</sub> into bicarbonate ions, accelerating carbon capture. Adapted to industrial conditions, its application in decarbonisation demonstrates a bio-inspired solution to face environmental challenges, making enzymatic solutions the preferred choice in the industry.

#### Simply Better

Enzymatic carbon capture technology simplifies the process by eliminating high-pressure absorbers, solvent recovery systems, and thermal regenerators. Leveraging enzymatic efficiency reduces energy-intensive steps and costly equipment, making carbon capture more accessible and sustainable and lowering capital and operational expenditures.

- **Quench Tower:** The initial step cools flue gas, condenses water vapour, and removes particulates and contaminants to prepare the gas for efficient CO<sub>2</sub> absorption.
- **Absorber Column:** Core of capture process where flue gas interacts with a solvent blend containing a carbonate and 1T1 Carbonic Anhydrase enzyme that boosts CO<sub>2</sub> absorption kinetics at low pressure.
- **Desorber Column:** This is the final stage, where the CO<sub>2</sub>-laden solvent is heated at a low temperature under a mild vacuum to release pure CO<sub>2</sub> for collection. This is environmentally sustainable and economically advantageous. Steam is not required.

#### Operational Advancements and Sustainability

Saipem's technology uses a non-volatile and inert solvent catalysed with Carbonic Anhydrase to decrease energy for CO<sub>2</sub> capture and regeneration, cutting costs by simplifying the process and yielding an environmentally sustainable and economically viable capture solution.

### BLUENZYMETM : REVOLUTIONIZING RISK MANAGEMENT

For operators keen on minimising project execution risks while enhancing operational efficiency, Bluenzyme™ represents a groundbreaking solution. This product line embodies the culmination of Saipem's enzymatic carbon capture technology in a modular, easily deployable format tailored to industrial applications' diverse needs.

#### Bluenzyme™'s Distinct Advantages

- **Risk Mitigation:** With its stable, non-toxic and non-volatile solvent, Bluenzyme™ significantly reduces the risks associated with chemical handling, exposure and license-to-operate. This feature uniquely benefits operators in industries where safety and environmental compliance are paramount.
- **Operational Flexibility:** Bluenzyme™ units offer unparalleled adaptability, designed to fit into existing industrial setups without extensive modifications. This plug-and-play approach minimises downtime and facilitates a smoother transition to carbon capture solutions, addressing a key concern for operators regarding operational disruption.
- **Cost Efficiency:** The modular nature of Bluenzyme™ products streamlines the implementation process, reducing capital and operational expenses. Using low-grade heat for solvent regeneration further enhances the economic appeal of Bluenzyme™, offering a cost-effective alternative to more energy-intensive solutions.
- **Environmental Impact:** In line with Saipem's commitment to sustainability, Bluenzyme™ units are engineered to have a minimal environmental footprint. By maximising CO<sub>2</sub> capture efficiency and minimising solvent waste, Bluenzyme™ supports operators in achieving their environmental and sustainability goals.

Bluenzyme™ stands out as a symbol of innovation and safety in carbon capture technology, offering a robust solution for discerning operators focused on risk reduction and operational excellence. Saipem's enzymatic carbon capture process, epitomised by Bluenzyme™, paves the way for a more sustainable industrial future, reducing the environmental impact of CO<sub>2</sub> emissions while maintaining economic and operational viability.

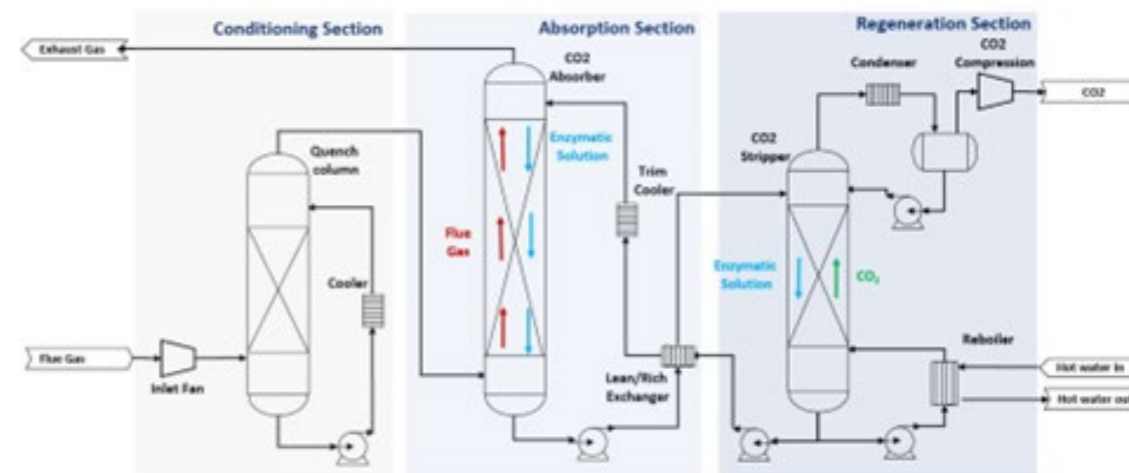



# ADIP ULTRA CARBON-CAPTURE TECHNOLOGY



Justin.Swain@shell.com

www.shell.com/ct

## SUMMARY

Shell Catalysts & Technologies offer a leading, amine based, high-capacity carbon-capture technology, ADIP ULTRA. ADIP technology is deployed at more than 500 Shell and non-Shell sites worldwide and has established an enviable record for cost-effective deep CO<sub>2</sub> removal in the natural gas sector. ADIP ULTRA, the latest development, uses an optimised solvent formulation and an improved design based on years of operational learnings. With the latest-generation column internals (Shell Turbo Trays), this technology can maximise CO<sub>2</sub> capture and meet deep specifications for the treated gas while optimising solvent circulation and regeneration duty.

## BENEFITS

The Shell ADIP ULTRA pre-combustion gas-treating process cost-effectively treats gases containing high CO<sub>2</sub> levels. It is proven for CCS at a 1-million tonnes/year CO<sub>2</sub>-capture scale and, compared with conventional process line-ups, it can help to:

- reduce capital cost through the latest-generation column internals (Shell Turbo Trays) in the absorber;
- low regeneration energy requirements determined using a highly enhanced modelling capability based on many years of operating experience and data;
- availability in advanced energy efficient line-ups that reduce capital and operating costs, depending on the treated gas specifications and application;
- a solvent that is robust to foaming upsets and does not suffer from any degradation, which leads to zero waste from the process; and
- a noncorrosive, nontoxic solvent.
- reduce equipment costs by up to 30%;
- cut regeneration energy requirements by up to 30%; and
- achieve deeper CO<sub>2</sub> removal.

## KEY DATA

TRL	9	Capture Rate Range (tpd)	100 - 3,000+	Modular (Y/N)	Yes*
Source CO <sub>2</sub> Purity Range	1 - 35 vol%	Energy Consumption (GJ/tCO <sub>2</sub> )	Design Specific	Capture Efficiency (%)	99.5%+
Number of Commercial Plants	2	Number of Pilot Plants	NA	Number of commercial references (all applications)	>15
Target Industries	Natural Gas and LNG, Hydrogen Manufacturing (including Blue H <sub>2</sub> ) and Refining.				

\* For smaller capacities of around 200-300 ktpa

## KEY PROJECTS

### Quest 1-million-t/y CCS project

The Scotford upgrader in Alberta, Canada, generates CO<sub>2</sub> during hydrogen manufacture. As part of the Quest CCS project, Shell's ADIP ULTRA technology captures CO<sub>2</sub> from the three hydrogen manufacturing units' process gas streams. The captured CO<sub>2</sub> is then dehydrated and compressed before being transported about 75 km by pipeline and injected and permanently stored 2 km underground. The facility has a proven CO<sub>2</sub>-capture capacity of over 1 million tonnes/year and has captured more than 8.5 million tonnes of CO<sub>2</sub> since coming online in 2015. The facility has better than projected reliability, cost and storage performance, and greater than 99% uptime. Its operating cost is approximately \$25/t of CO<sub>2</sub> and it would cost about 30% less if built today.

## TECHNOLOGY DESCRIPTION

ADIP technology dates to the 1950s. In 2000, ADIP-X technology was introduced; this featured a significantly upgraded solvent that unlocked a step change in CO<sub>2</sub> removal capability. The latest generation of this arrived in 2017 with ADIP ULTRA, which has several enhanced design features, compared with previous-generation technology, that further reduce the cost of CO<sub>2</sub> removal. These include a shorter absorber column, reduced solvent circulation, a slimmer regenerator and a smaller reboiler (Figure 1).

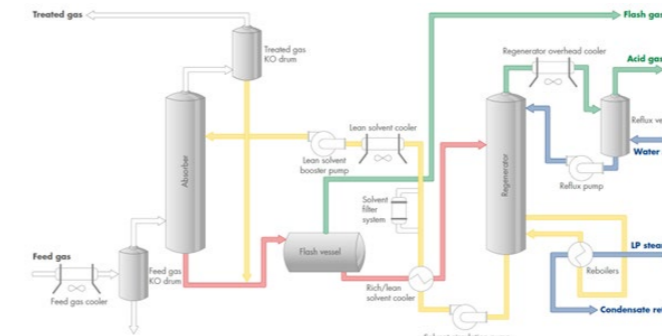

Figure 1. The Shell ADIP ULTRA process.

Combining ADIP ULTRA technology with Shell's new absorption column internals, Shell Turbo Trays, can further enhance process performance. At the column scale, liquid and gas flow counter-currently, that is, gas moves up while the liquid solvent moves down. However, on each tray within each element, gas and liquid flow co-currently within multiple contacting boxes before being separated effectively (Figure 2). Contact between the gas and the liquid is increased significantly, which enables higher mass transfer rates. The net effect is to increase the hydraulic limits of the system, which means operators can process higher CO<sub>2</sub> concentrations and increase capacity by up to 80%, or reduce the column diameter by up to 35% and the weight by up to 50%.

ADIP ULTRA technology uses two amines, methyl diethanolamine (MDEA) as the main reactant and piperazine as the accelerator, and water. It can help to reduce the capital and operating costs of grassroots plants and revamps owing to the solvent's high capacity for CO<sub>2</sub> and its low circulation rate compared with using aqueous MDEA. ADIP ULTRA solvent can facilitate efficient and stable operations owing to its characteristics of low levels of hydrocarbon solubility, foaming, fouling, corrosion and degradation.

The line-up can be varied, for example, using a hot flash instead of the regenerator, depending on the CO<sub>2</sub> removal requirements. This line-up is fully de-risked and part of the Shell Blue Hydrogen Process.

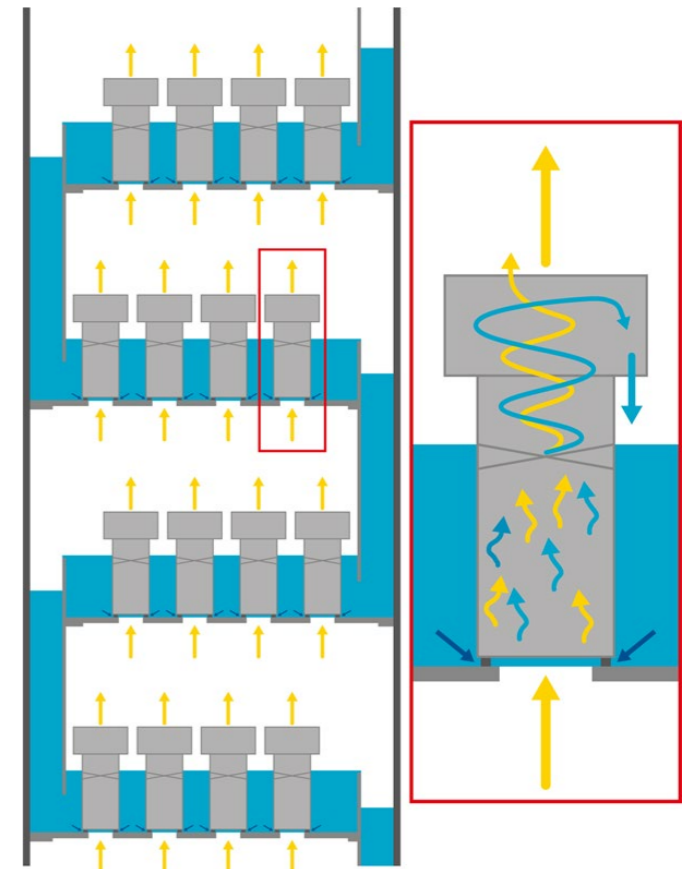

Figure 2. Increased capacity from Shell Turbo Trays.

## PORTHOS CCS PROJECT

In September 2021, a final investment decision was made to build an 820,000 tonnes/year biofuels facility as part of the transformation of Pernis refinery, the Netherlands, into the Shell Energy and Chemicals Park Rotterdam, one of five global energy and chemical parks. Once built, the facility will be among the biggest in Europe to produce sustainable aviation fuel and renewable diesel made from waste. Part of the CO<sub>2</sub> emissions from the manufacturing process will be captured using Shell's ADIP ULTRA technology and stored in a depleted North Sea gas field as part of the Porthos CCS project. Final investment decision for Porthos CCS project taken in Oct 2023. Construction activities have started in Jan 2024. Expected to be in operation in 2026.



# CANSOLV CO<sub>2</sub> CAPTURE TECHNOLOGY



Image provided courtesy of Saskpower

[valerie.leveille@shell.com](mailto:valerie.leveille@shell.com)

[rebecca.eason@ten.com](mailto:rebecca.eason@ten.com)

## SUMMARY

Shell Catalysts & Technologies, in partnership with Technip Energies, offer a leading, amine-based, high-capacity post-combustion carbon capture technology, CANSOLV CO<sub>2</sub> Capture System, that is robust and proven, and has an established record of performing cost-effectively in a range of industries. Learnings and expertise developed from 10 years of commercial, at scale, operational experience translate to a robust continuous innovation program and amine technology expertise.

Technip Energies support integration of CANSOLV CO<sub>2</sub> Capture System into both new build and existing plants. With a strong focus on optimum heat and energy integration, intelligent use of space and tie-ins, enhanced constructability and construction methodologies and project management excellence, Technip Energies ensure the best possible application of CANSOLV™ System for each facility. The alliance is engaged with the world's largest CCS projects and has secured many competitive FEED and technology selection wins.

## BENEFITS

- **Proven track record.** Proven performance in large-scale CCS applications, including 10 years' of continuous CO<sub>2</sub> capture operation from the landmark SaskPower station.
- **Superior solvent management.** SC&T is an established world-class partner for solvent management as required by CCS projects, i.e.: technical services, environmental permitting support, supply chain management, solvent performance, etc;
- **Adaptable.** Highly adaptable for retrofit and greenfield projects, plus a wide variety of plant sizes and industrial applications.
- **Cost effective.** Cutting-edge performance via minimum parasitic energy consumption, fast kinetics and low volatility, combined with modularised approaches and value engineered design to reduce capital and operating costs.

## KEY PROJECTS

- **Humber Zero, UK:** Retrofit of CANSOLV® technology to the VPI Immingham 1.2 GW combined heat and power station and the Phillips 66 Refinery for FCC emissions.
- **BP Net Zero Teesside Power, UK:** BP has awarded an EPC contract to the Technip Energies and GE Vernova consortium, including Balfour Beatty, with Shell CANSOLV® as licensor for CO<sub>2</sub> capture up to 2 Mtpa at one of the world's first commercial-scale gas-fired power stations with integrated CCS.
- **Calpine Baytown, USA:** Technip Energies and Shell CANSOLV® are progressing the retrofit of carbon capture to an 830-MW gas fired power station designed to capture 2.2 Mtpa CO<sub>2</sub>
- **Viridor Runcorn CCS, UK:** Viridor has awarded the FEED contract to Technip Energies with Shell CANSOLV® as licensor for CO<sub>2</sub> capture up to 0.9 Mtpa at an Energy from Waste facility

## KEY DATA

TRL	9	Capture Rate Range (tpd)	250 to +20,000 (FEED delivered for a facility)	Modular (Y/N)	Yes
Source CO <sub>2</sub> Purity Range	2 - 30%	Energy Consumption (GJ/tCO <sub>2</sub> )	Design specific	Capture Efficiency (%)	98%+
Number of Commercial Plants	2	Number of Pilot Plants	2 operating in 2024	Number of FEEDs delivered or in progress	21
Target Industries	Large scale gas-fired power facilities, petrochemical & refineries, gas processing facilities, waste to hard to abate (cement, steel), waste/biomass power facilities				

## TECHNOLOGY DESCRIPTION

As a standalone, low-pressure, CO<sub>2</sub> capture technology, CANSOLV CO<sub>2</sub> Capture System is well-suited for either retrofitting to existing plants or including in greenfield developments. It uses a regenerable proprietary amine to capture CO<sub>2</sub> that is released as a pure stream, which makes the technology highly suitable for both sequestration and utilisation projects. The CANSOLV® CO<sub>2</sub> Capture System can capture up to 99% of the CO<sub>2</sub> from post-combustion streams, is operationally proven for CCS at a 1 Mtpa CO<sub>2</sub> capture scale and has been designed for FEED packages at up to 8 Mtpa capacity. Our units have been designed to date for commercial application for CO<sub>2</sub> concentrations from 3.5 to 27%, and gas flow rates from 11,000 to 4,500,000 Nm<sup>3</sup>/h.

The CANSOLV CO<sub>2</sub> Capture System has been in commercial operation at two industrial facilities for 10 years. This unique commercial experience, combined with a world-class continuous innovation program and numerous piloting campaigns at a wide-range of industrial facilities, translates to cutting-edge technology performance.

## SASKPOWER: WORLD'S FIRST 1 MTPA POWER GENERATION CCS PROJECT

In 2014, the power station became the first in the world to successfully use CCS at scale. SaskPower chose to add a CANSOLV SO<sub>2</sub>-CO<sub>2</sub> Integrated Capture System for combined carbon capture and flue-gas desulphurisation from a 150-MW unit that was due for refurbishment. The plant now celebrates 10 years of commercial operation with the capacity to capture up to 1 Mtpa CO<sub>2</sub>, thereby helping SaskPower to meet strict Canadian regulations on CO<sub>2</sub> emissions from coal-fired power stations and thus retain its licence to operate. The CO<sub>2</sub> is compressed, transported through pipelines and permanently stored in deep geological formations as part of an enhanced-oil-recovery operation. The captured SO<sub>2</sub> is converted to 60 tpd of sulphuric acid that sold as a feedstock for the local fertiliser industry. The learnings from this still-operating, first-of-a-kind deployment continue to help develop Shell's CANSOLV CO<sub>2</sub> capture technology and promote and develop CCS projects globally.

## CONTINUOUS IMPROVEMENT AND TECHNOLOGY DEVELOPMENT

Shell invests in a highly active R&D programme that is designed to address the important questions that projects will face: addressing new and evolving performance requirements; lowering the costs of CO<sub>2</sub> capture; and improving operability. A sample of the numerous development activities underway include amine emissions management, next generation solvent and formulation development, reduction in energy demand and dispatchable operation. This program is yielding strong results as evidenced by recent and upcoming technical publications. Both commercial facilities and projects in development benefit from Shell's continuous innovation technology program.

\*CANSOLV is Shell trademark

## CANOPY BY T.EN POWERED BY SHELL CANSOLV CO<sub>2</sub> CAPTURE TECHNOLOGY

Shell Catalysts & Technologies and Technip Energies have been working as an alliance since 2012, developing design improvements to enhance performance and reduce both capital and operational expenditure. We have been working in partnership to deliver a wide range of carbon capture unit sizes and offerings, to meet the needs of every emitter. Our pilot plant facilities offer in-situ testing and performance verification for all types of flue gas, whereas our small to mid-scale modular and containerised units deliver cost and schedule enhancements and project execution risk reduction in comparison with conventional bespoke approaches. Our robust, large-scale bespoke designs have been proven to cater to the most complex of projects and world first applications. Some developments underway include:

- Increased range of standardised and modularised design capacities for both onshore and offshore application.
- Enhanced construction and deployment methods

Canopy by T.EN™ is a flexible, integrated suite of post-combustion carbon capture solutions for any emitter, powered by the proven Shell CANSOLV® CO<sub>2</sub> Capture System. Our products allow clients to de-risk their projects, capture with confidence and meet their targets quickly, efficiently and affordably, regardless of scale, industry or location. From testing and piloting up to the world's largest installations, we've got our clients' carbon capture needs covered.



- **Capture Performance** - Powered by leading Shell CANSOLV technology, Canopy by T.EN™ solutions deliver CO<sub>2</sub> recovery rates above 95% and feature excellent energy efficiency, low solvent volatility and minimal emissions. Digital by design, our capture plants are fully instrumented and completely automated for unmanned operations and plant performance monitoring.
- **Capture Capacity** - From pilot schemes to custom solutions for large scale-emitters, Canopy by T.EN™ solutions are available in a comprehensive range of sizes to build the carbon capture capacity you need.
- **Capture Support** - Every carbon capture journey is different. So we're with you every step of the way, solving challenges from funding to implementation with our complete Canopy by T.EN™ package.

# LOW PARTIAL PRESSURE CO<sub>2</sub> CAPTURE TECHNOLOGY



guobs.nhgs@sinopec.com

www.NRICI.sinopec.com

## SUMMARY

NRICI carried out relevant R&D work as early as the 1980s and developed the first generation of technology which uses MEA as the main body while adding active amine, antioxidant, and corrosion inhibitor components. During the 12th and 13th Five-Year Plan periods, based on the national projects, the solvents, and processes developed have been continuously upgraded, and the regeneration energy consumption has been reduced from 4.0 GJ/tCO<sub>2</sub> to 2.4 GJ/tCO<sub>2</sub>. The third-generation technology with a regenerative energy consumption of 2.0 GJ/tCO<sub>2</sub> is being developed and is expected to be demonstrated on a large industrial scale by 2025. This technology was industrially applied as early as 1999 in Guizhou Chitianhua's 5,000 tonnes/year flue gas carbon capture plants, and then it has been applied in many coal-fired power plants, such as Huaneng, Sinopec, Huadian, Guoneng, etc. At present, this technology has been applied in 57 domestic and foreign plants, with an annual capacity of more than 1 million tonnes.

## BENEFITS

- **High efficiency and low energy consumption:** Optimise and improve the existing carbon capture solvents, processes, and equipment. Under energy-efficient process conditions, regeneration heat consumption has been reduced to 2.0 GJ/tCO<sub>2</sub>.
- **Excellent anti-degradation properties:** Developed the corresponding corrosion inhibitor and antioxidant system.
- **Advanced technology index:** Overall at a domestic leading international advanced level in carbon capture technology.
- **Systematic research systems:** Including basic research, laboratory pilot studies, scale-up molding studies, sideline studies, and industrial demonstration studies.

## KEY PROJECTS

- **Project One:** Industrialised application in Huaneng Shanghai Shidongkou Power Plant 120,000 tonnes/year flue gas CO<sub>2</sub> capture unit.
- **Project Two:** Industrialized pilot study on 40,000 tonnes/year CO<sub>2</sub> capture unit in Sinopec Shengli Power Plant.
- **Project Three:** Industrialised application in the largest coal-fired power plant flue gas carbon capture unit in operation in China - Guoneng Shaanxi Guohua Jinjie Power Plant 150,000 tonnes/year flue gas CO<sub>2</sub> capture unit.

## KEY DATA

TRL	9	Capture Rate Range (tpd)	>400	Modular (Y/N)	No
Source CO <sub>2</sub> Purity Range	~11%	Energy Consumption (GJ/tCO <sub>2</sub> )	<2.4	Capture Efficiency (%)	~
Number of Commercial Plants	~	Number of Pilot Plants	10		
Target Industries	Power and Cement				

## TECHNOLOGY DESCRIPTION

By 2015, NRICI successfully screened a high-efficiency and low-energy capture solvent MA-1 after basic research, lab scale test, and 5 Nm<sup>3</sup>/h test research. After an industrialised pilot study on a 40,000 t/y CO<sub>2</sub> capture unit in Shengli Power Plant, it successfully carried out an industrialised application in Sichuan Vinylon Plant, and the results showed that compared with the original MEA method, the solvent circulation volume decreased by 34.7%, the regeneration energy consumption decreased by 41.8%, the consumption of circulating water is reduced by 200 t/h, and the cost is significantly reduced under the condition that the production requirements are met.



By 2020, NRICI continued to optimise the solvent and technology and successfully developed a new high-efficiency and low-energy capture solvent MA-2. According to the results of the small-scale and pilot-scale test study, the comprehensive performance of this solvent is better than other existing absorption systems on the market, and finally applied to the largest coal-fired power plant flue gas carbon capture unit in operation in China - Guohua Jinjie Power Plant 150,000 tonnes/year flue gas carbon capture unit. The application results showed that under the optimised test conditions, the capture rate is 96%, the regeneration energy consumption is <2.4 GJ/tCO<sub>2</sub>, the operating loss is ~1.0 kg/tCO<sub>2</sub>, and the overall level reaches the international advanced level.



By 2024, through coupling solvent, process, and equipment, NRICI has upgraded the latest generation of solvent MA-3, then constructed and operated a set of 1,000 tonnes/year absorption method pilot plant, which can reduce the regeneration heat consumption to 2.0 GJ/tCO<sub>2</sub>, and further improve the level of the existing absorption method flue gas CO<sub>2</sub> capture technology.

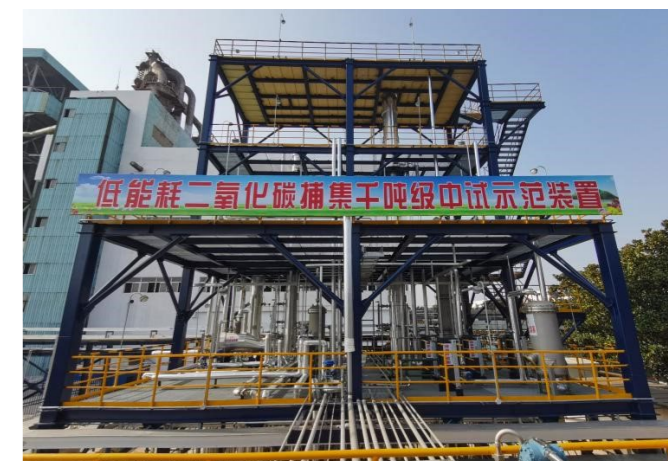



guobs.nhgs@sinopec.com

www.NRICI.sinopec.com

### SUMMARY

NRICI started research on polyamine decarbonisation technology in the 1980s and developed the NCMA decarbonisation technology in 2003. Through proprietary decarbonisation solvents, flexible process flow, and precisely matched process parameters, NCMA decarbonisation technology can achieve customised requirements for CO<sub>2</sub> content in purified gas, down to meet the requirements for CO<sub>2</sub> in the feed gas to deep-cooled separation systems such as LNG, and outperforms similar products in the industry in terms of corrosion and foaming.

### BENEFITS

- **Customised CO<sub>2</sub> purification degree:** By controlling the CO<sub>2</sub> purification as required by the process specifications, NCMA can remove CO<sub>2</sub> to a molar fraction of <math>20 \times 10^{-6}</math>.
- **Simultaneous removal of sulphides:** The sulphide is removed without increasing equipment or energy consumption, and the H<sub>2</sub>S in the sulphide can be removed to a molar fraction of  $1 \times 10^{-6}$  or less.
- **High absorption capacity:** The CO<sub>2</sub> equilibrium absorption capacity of NCMA is 50-70 L/L, and its absorption capacity can be varied in the range of 15-70 L/L.
- **Low regeneration energy consumption:** Due to the high absorption capacity of the NCMA, the regeneration heat energy consumption is reduced for the same processed gas volume.
- **Less solvent loss:** The vapour partial pressure of NCMA is low, the vapour pressure of pure solvent at room temperature is <math>0.01 \text{ mmHg (1.3Pa)}</math>, and the gas is less entrained after cooling and separation.

### KEY PROJECTS

- **Project One:** Two sets of 1.5 million m<sup>3</sup>/d natural gas decarbonisation units at the Songnan gas field, removing CO<sub>2</sub> from 25% to less than 3%, with unit energy consumption reduced by more than 25%.
- **Project Two:** The 1 million m<sup>3</sup>/d shale gas to LNG decarbonisation unit at Fuling gas field, removing CO<sub>2</sub> to less than  $50 \times 10^{-6}$ .
- **Project Three:** The 20 t/h dry gas decarbonisation unit at Zhenhai Refining Company, with purified gas CO<sub>2</sub><math><0.1\% \text{ (vt)}</math>, is better than the design value.
- **Project Four:** The 240,000 Nm<sup>3</sup>/h conversion gas to ethylene glycol decarbonisation unit at Zhongkun Company, which is the largest natural gas to ethylene glycol plant in China, removing CO<sub>2</sub> to less than  $20 \times 10^{-6}$ .
- **Project Five:** Blast furnace gas decarbonisation unit at Xinjiang Bayi Steel-Xinjiang Bayi Steel's 2,500 m<sup>3</sup> Hydrogen-rich Carbon Recycling Oxygen Blast Furnace (HyCROF) Commercial Demonstration Project, which is the world's first long-process Hydrogen-rich Carbon Blast Furnace for iron-making.

### KEY DATA

TRL	9	Capture Rate Range (tpd)	~	Modular (Y/N)	No
Source CO <sub>2</sub> Purity Range	1 - 40%	Energy Consumption (GJ/tCO <sub>2</sub> )	~	Capture Efficiency (%)	70 - 99.9%
Number of Commercial Plants	>100	Number of Pilot Plants	~		
Target Industries	Steel and Petrochemical				

### TECHNOLOGY DESCRIPTION

The NCMA decarbonisation technology developed by NRICI can achieve customised demand for CO<sub>2</sub> content in purified gas through proprietary decarbonisation solvents, flexible process flow, and accurately matched process parameters, which is as low as to meet the requirements of LNG and other deep-cooling separation systems for CO<sub>2</sub> in the feed material, and is superior to similar products in the industry in terms of corrosion, foaming, and other aspects.

In 2009, NCMA decarbonisation solvent was awarded the Gold Prize of the 18th National Invention Exhibition issued by the China Invention Association; in 2011, it was also recognised as a national key new product by the Ministry of Science and Technology of the PRC; in 2014, it was awarded the Third Prize of Scientific and Technological Advancement by SINOPEC Group Corporation for its application in decarbonisation of high carbonaceous natural gas; in 2018, it was awarded SINOPEC Group Corporation's Third Prize for Technical Invention; in 2020, one of its main patents, ZL200310106567.9, won the 21st China Patent Excellence Award.



Project 3



Project 1



Project 4



Project 2



Project 5



[ccus@akercarboncapture.com](mailto:ccus@akercarboncapture.com)

[www.akercarboncapture.com](http://www.akercarboncapture.com)

**SUMMARY**

SLB and Aker Carbon Capture Joint Venture (SLB-ACC JV) is a pure play carbon capture company with products and services for a range of industries. SLB-ACC JV has a proprietary and proven decarbonisation technology for sectors including cement, gas-to-power, biomass and waste-to-energy, blue hydrogen, refining, process industries and pulp & paper. SLB-ACC JV is delivering seven facilities, the first of which will be ready to capture CO<sub>2</sub> in 2024.

The business covers the delivery of complete modular units, license models with key equipment, aftermarket services and a full value chain Carbon Capture as a Service. The range of modular Just Catch™ units covers sizes of 40,000, 100,000 and 400,000 tonnes CO<sub>2</sub> capture per year.

SLB-ACC JV's technology has high energy efficiency and leading HSE characteristics, targeting no harm to workers, communities or environment. This fits both existing and newbuild facilities and has extensive real-world validation, with over 60,000 hours of operation across a wide range of industries across a wide range of industries and at Technology Centre Mongstad.

**BENEFITS**

- Highly energy-efficient capture process with innovative heat integration solutions.
- Includes proprietary ACC™ advanced emission control to prevent the formation of amine mist; this nearly eliminates emissions of amine and amine degradation products.
- The ACC™ CO<sub>2</sub> capture process, including CO<sub>2</sub> liquefaction, intermediate storage and CO<sub>2</sub> export has been qualified by DNV-GL according to DNV-RP-A203 Qualification Procedures for New Technology and DNVRP-J201 Qualification Procedures for CO<sub>2</sub> Capture Technology.
- The JV's solvent technology is robust and allows for environmentally-friendly operations. The proprietary ACC™ solvents show very low solvent degradation, meaning low corrosion issues with the plant, low amine make-up requirements, low emissions of amine degradation products, low demand for amine reclamation, and low production of reclaimer waste.

**KEY PROJECTS**

- **Twence CCU [capture capacity: 0.1 Mtpa]** - This project captures CO<sub>2</sub> from waste-to-energy in the Netherlands for use in the horticultural sector to enhance crop growth, thereby reducing emissions from conventional CO<sub>2</sub> generation.
- **Heidelberg Materials Brevik CCS [capture capacity: 0.4 Mtpa]** - Brevik CCS will be the world's first large-scale CO<sub>2</sub> capture on cement production and is part of the Norwegian Longship project. The process utilises waste heat from the cement and CO<sub>2</sub> compression plants via proprietary heat integration.
- **Ørsted Kalundborg Hub CCS [capture capacity: 0.5 Mtpa]** - Delivering five Just Catch™ units to Ørsted's Asnæs and Avedøre bioenergy plants, enabling carbon removal. The project is funded by the Danish government and Microsoft as purchaser of CDRs.
- **Mobile Test Unit (MTU)** - Built in 2008, the MTU has validated SLB-ACC JV technology across a range of industries. This is essentially a full-scale plant in miniature and has been continuously upgraded since delivery.

**KEY DATA**

TRL	9	Capture Rate Range (tpd)	~	Modular (Y/N)	Yes
Source CO <sub>2</sub> Purity Range	~	Energy Consumption (GJ/tCO <sub>2</sub> )	~	Capture Efficiency (%)	~
Number of Commercial Plants	7	Number of Pilot Plants	2		
Target Industries	Cement, waste-to-energy, gas-to-power, biogenic, refining, process, pulp and paper				

**TECHNOLOGY DESCRIPTION**

**PROPRIETARY AND PROVEN TECHNOLOGY**

SLB-ACC JV's Carbon Capture's technology has robust patent protection and is based on a health, safety and environmentally (HSE) friendly solvent portfolio developed with the aim of no harm to workers on site, surrounding communities or the environment, along with high energy efficiency. It can be applied to both existing and new build plants, and has extensive real-world validation, with more than 60,000 hours of operation to date across a range of carbon emitting industries. The company considers research, innovation, and technology development to be key drivers of competitive advantage, and has an active program focused on reducing costs, developing and qualifying new capture technologies, and improving capture project economics. This includes capture efficiency, modularisation, and the implementation of digital capabilities.

The Advanced Carbon Capture™ (ACC™) proprietary solvents were developed in an eight-year R&D program (SOLvit) together with industry and research partners. Numerous solvent mixtures were tested across energy consumption, robustness, toxicity, material compatibility, and – most importantly – HSE performance. The SOLvit program resulted in energy-efficient solvents and reduced solvent consumption and thus reduced OPEX. Compared to traditional amines, the JV's Carbon Capture's proprietary solvents also minimise degradation products, which can have an impact on corrosion and the need for maintenance. The ACC™ capture technology, including the ACC™ solvents and ACC™ Emission System, has been tested and verified on flue gases from gas-fired and coal-fired power plants, cement kilns, waste-to-energy plants, hydrogen plants, char manufacture and smelting, with in total more than 60,000 hours of operating experience from the US, UK, Germany, Scotland, Sweden, Poland, and Norway.

Energy optimisation is critical for carbon capture as it significantly reduces energy consumption. At SLB-ACC JV, energy optimisation, heat integration, and waste heat recovery are prioritised areas. The company offers highly effective solutions for energy optimisation, tailored to specific industrial applications and site-specific conditions. The recommended solution is based on the overall energy performance of the parent and the capture plants.

The main stages of the ACC™ process include the Direct Contact Cooler (DCC), the absorber and desorber columns, the reboiler, the reclaimer, the energy saver, the flue gas fan, and a liquefaction unit with optional proprietary advanced heat integration.

Flue gas from the emitter is extracted downstream of any existing emission control units through the flue gas fan and is pre-treated in the DCC. The DCC cools the flue gas and removes any acid gases such as SO<sub>2</sub>, HCl, and HF. Condensed water from the flue gas exits the DCC as a bleed stream.

Flue gas from the DCC is routed to the CO<sub>2</sub> absorber downstream of the booster fan. The absorber consists of a CO<sub>2</sub> absorption section in the lower part of the column, and a water wash section with emission control in the

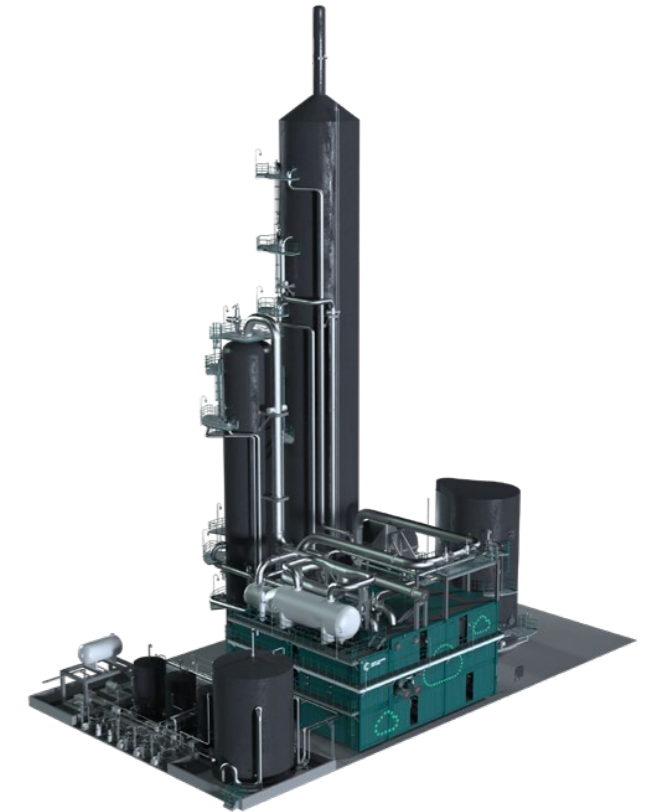

Illustration: Just Catch™ 400

upper part of the column. In the absorption section, flue gas contacts the lean amine solvent in a countercurrent flow, absorbing CO<sub>2</sub>. In the upper part of the column, emission control including the ACC™ Anti-Mist design cools and cleans the CO<sub>2</sub>-lean flue gas of traces of amines and potential degradation products, thus effectively preventing emissions of amine and any degradation products as aerosols. CO<sub>2</sub>-lean flue gas is either emitted from the absorber stack or returned to the existing flue gas stack downstream of the flue gas extraction point.

CO<sub>2</sub>-rich amine solvent is drained from the absorber sump and regenerated using steam. The steam is condensed in a reboiler and returned as hot condensate. The increase in temperature during the indirect heating of rich solvent strips the CO<sub>2</sub> from the solvent. The resulting lean amine is returned to the absorber for reuse in the capture process, while CO<sub>2</sub> exits the top of the desorber. The energy saver consists of a proprietary process that reduces the steam consumption in the reboiler.

The CO<sub>2</sub> is then compressed and fed into a regional CO<sub>2</sub> pipeline or compressed and liquified for transport by ship or truck. The ACC™ proprietary technology enables internal heat recovery from compression that also reduces the overall steam requirement for the carbon capture plant.

To maintain high solvent performance, a reclaimer is included to intermittently remove impurities and degradation products, generating a small amount of concentrated liquid waste. This needs to be disposed of batch-wise as chemical waste. Due to the low degradation rate of the ACC™ solvents, along with a properly designed DCC, the amount of reclaimer waste from the ACC™ process is very low compared to standard plants using generic solvents such as MEA.



frank.ligthart@shi-g.com

www.shi-g.com

**SUMMARY**

SFW CaL+ solution based on the Calcium Looping (CaL) capture technology, is a scalable and retrofitable post combustion CO<sub>2</sub> removal system. The solution is built on SFW's experience of delivering over 500 Circulating Fluidised Bed reactors (CFBs) commercial units.

SFW CaL+ is a multi-product, cost- and environmentally effective and highly adaptable solution for capturing carbon emissions. The solution serves the energy from waste, cement, steel, pulp & paper and metallurgical industries

**BENEFITS**

- CO<sub>2</sub> capture efficiency higher than 90%
- Added value in the form of co-production of green electricity and carbon-free lime
- Captures other acid gases and can treat high temperature flue gas sources
- Commercially available, scalable, and cost-effective components
- Can be integrated to emission source in cement, steel and other carbon intensive industry
- Oxygen synergy and sector coupling with green hydrogen and Power to X (P2X) plants.'



Calcium Looping 1.7 MW demo plant completed in La Pereda, Spain. The pilot plant was commissioned in 2012 with demonstrated capture efficiency of over 90%

**KEY DATA**

TRL	6	Capture Rate Range (tpd)	>50	Modular (Y/N)	No
Source CO <sub>2</sub> Concentration	>5%	Energy Consumption (GJ/tCO <sub>2</sub> )	Dependent on plant integration level	Capture Efficiency (%)	90 to 95%+
Number of Commercial Plants	~	Number of Pilot Plants	~	Source of Energy for Carbon Capture	Fuel
Target Industries	Cement, Metallurgical and Heavy Industry				

**TECHNOLOGY DESCRIPTION**

**CALCIUM LOOPING**

Calcium looping or CaL utilises a natural and non-toxic sorbent, calcium, to capture and release high purity CO<sub>2</sub>. The energy required to capture CO<sub>2</sub> is supplied via the oxyfuel calcination of sustainably sourced bio-residues and waste.

CaL creates added value for industrial plant operators in the form of circular economy applications, decarbonising energy generation and enabling sector coupling opportunities. In essence, CaL addresses scope 1, 2 and 3 emissions. CaL is supplied either as a tail-end configuration, capturing CO<sub>2</sub> and producing energy and lime, or as an integrated configuration in which the capture system exchanges material and heat streams with existing industrial units.

As such, CaL can be integrated to any industrial emission source, especially those with an existing lime cycle in operation such as cement, steel, and pulp and paper. The sorbent purged from the capture system, a mixture of lime and valuable minerals, is a viable feedstock, for the green manufacturing of construction materials.

Like oxyfuel, CaL provides synergy with green hydrogen plants, whereas cheap and available by-product oxygen is utilised for the carbon capture purposes. This leads to reductions in capture costs and the efficient synthesis of carbon negative fuels and materials.

CaL is a multiproduct technology which drives project feasibility due to numerous potential revenue streams, such as, excess electricity, high quality heat, waste gate fees, carbon removal credits, calcined lime and hydrogen or nitrogen from the oxygen production plant.

Calcium Looping has been tested and demonstrated since 2012 under industrial operating conditions at the La Pareda power plant, Spain. Sumitomo SHI FW has supplied the demonstration unit and continued to support innovation with our technical advisory services

**FEATURED PROJECTS:**

**1.7 MW CaL demo plant in LaPareda, Spain**

Supplied and commissioned by Sumitomo SHI FW in 2012, the plant (see picture left) demonstrated a capture efficiency of over 90%. The plant has continued to operate flexibly for over 5,000 hours under different process conditions to optimise the technology.

**CaLby2030 project for hard to abate sectors**

Sumitomo SHI FW will design and engineer three integrated CaL pilot plants to be operated in relevant industrial environment across Europe. The demonstration campaigns will be carried out with the aim of exceeding 90% CO<sub>2</sub> capture rates and even approaching 99% in specific configurations. The demonstrated results will be then scaled up to generate concepts and basic designs for the commercial carbon capture projects for Thomas Zement's integrated cement plant in Karsdorf, Germany, Alleima's Sandviken steelworks plant in Sweden, Hunosa's LaPareda power plant in Spain and IREN's waste to energy plants in Italy.

**HERCCULES project for WtE plants**

SFW will engineer a CaL carbon capture plant to be installed at the Milan Silla-2 waste-to-energy plant, owned and managed by a2a Ambiente, a member of the a2a group. The plant is one of the largest Italian waste management facilities that handles around 550 000 tons of municipal solid waste and non-hazardous special waste per year. The pilot plant will operate for up to 4000 hours and the project will conclude with the design and development of FOAK commercial size facility.

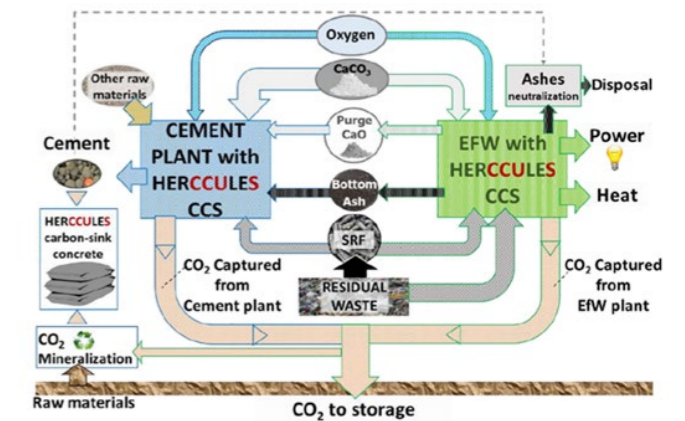

Sector coupling opportunity and material flows enabled by CaL capture system (Source: HERCCULES project)

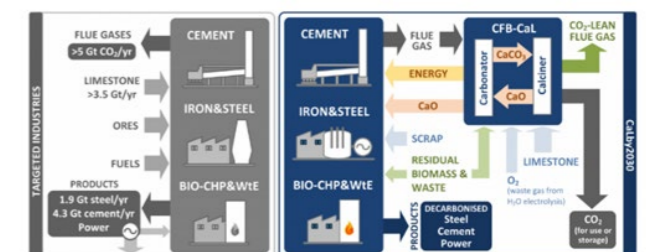

(left) Reference industries targeted in CaLby2030 and their mass flows; (right) Integrated CaLby2030 concept to avoid CO<sub>2</sub> emissions from high temperature industrial processes and residual-biomass-fired power plants.

CaL industrial cases examined in the CaLby2030 project (Source: CaLby2030 project)

Funded by the European Union under the Horizon Europe Framework Programme (Project name: CaLby2030; grant number: 101075416),(HERCCULES, grant number: 101096691). Views and opinions expressed are however those of the author(s) only and do not necessarily reflect those of the European Union or European Climate, Infrastructure and Environment Executive Agency (CINEA). Neither the European Union nor the granting authority can be held responsible for them."



frank.ligthart@shi-g.com

www.shi-g.com

**SUMMARY**

SFW HPC+ is a liquid solvent carbon capture solution based on the well-proven Hot Potassium Carbonate (HPC) process. The solution enables capture rates of over 90% from industrial stacks. HPC is a widely available, low-cost, safe, and environmentally friendly solvent.

The SFW HPC+ solution enables lower energy consumption in the capture process than comparable post-combustion capture technologies. The carbon capture plant can be powered with electricity only or a combination of power and steam, giving more flexibility in implementation, whereas the low grade heat is recovered in the form of district heating.

**BENEFITS**

- HPC is a well-proven carbon capture technology with hundreds of references and decades of operational experience in the chemical and Oil & Gas industries.
- Potassium carbonate solvent is a low-cost with low make-up need, reducing the solvent management cost of the carbon capture plant.
- HPC solvent does not pose risks to environment and health, facilitating simpler permitting.
- SFW HPC+ solution enables flexible configurations and can be retrofitted to any industrial emissions
- SFW HPC+ solution has low energy penalty for capture purposes, whereas consumed energy can be recuperated in the form of low grade heat.
- SFW HPC+ process gives a high capture rate over 90% and produces a high purity CO<sub>2</sub> product suitable for compression purposes.



Sumitomo SHI FW (SFW), together with partner Capsol Technologies ASA, and Swedish energy company Växjö Energi AB collaborate on a testing campaign to demonstrate carbon capture technology based on the hot potassium carbonate (HPC) process.

**KEY DATA**

TRL	7	Capture Rate Range (tpd)	>50	Modular (Y/N)	Yes
Source CO <sub>2</sub> Concentration	>5%	Energy Consumption (GJ/tCO <sub>2</sub> )	1.5 - 1.7	Capture Efficiency (%)	80 - 95%
Number of Commercial Plants	~	Number of Pilot Plants	~	Source of Energy for Carbon Capture	Electricity and/or Steam
Target Industries	Biomass and Waste to Energy Plants				

**TECHNOLOGY DESCRIPTION**

**HOT POTASSIUM CARBONATE, HPC**

SFW HPC+ capture technology starts with the cooling and compression of flue gas to enhance CO<sub>2</sub> absorption. The capture system removes CO<sub>2</sub> and regenerates the solvent via the following reversible reaction:



Expanding the CO<sub>2</sub> depleted flue gases over an expander, recovers a large part of the compression energy. The heat recuperated from the flue gas and product CO<sub>2</sub> streams is used internally in the capture system and the remaining heat can be exported to an available district heating network.

The SFW HPC+ plant is aimed at producing biogenic CO<sub>2</sub> from retrofitting biomass and waste to energy plants with carbon capture, creating potentially negative emissions or providing biogenic carbon for e-fuel synthesis.

The carbon capture plant can also be delivered as part of a new build waste-to-energy plant, or be retrofitted to existing incineration lines without any major modifications needed at the existing site.

SFW, in partnership with Capsol Technologies ASA, announced the delivery of two SFW HPC+ demonstration campaigns to be executed and hosted at SFW's client base in the Nordics. The campaigns, spanning a combined duration of 8 months, are set to take place at an Energy from Waste (EfW) plant and a Biomass to energy plant.

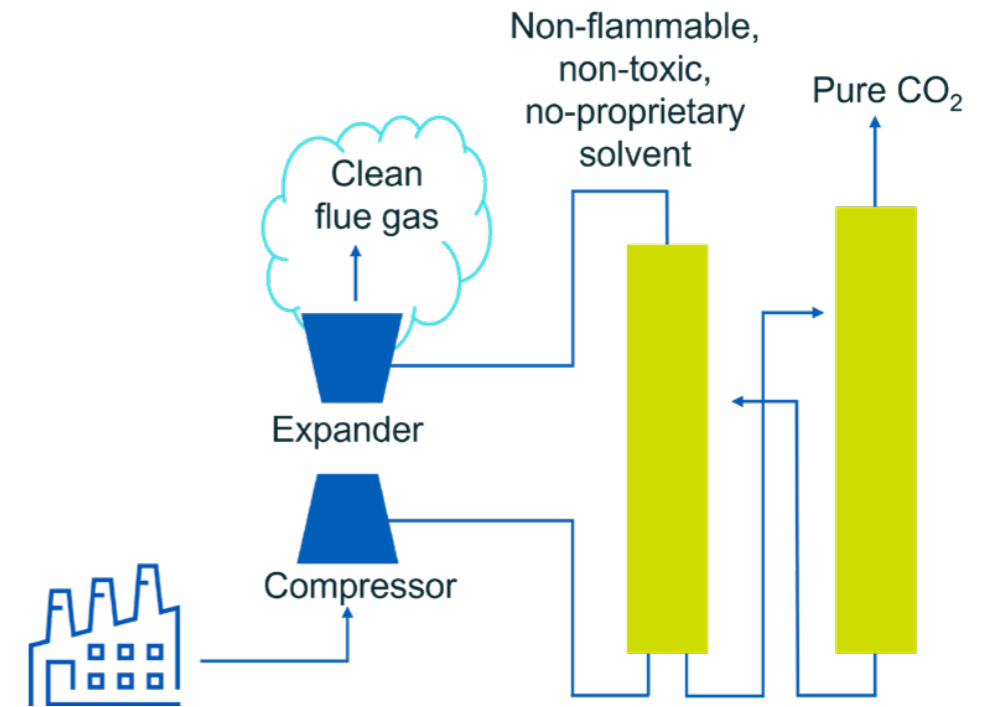

Schematic of HPC solution (Source: Capsol Technologies AS)



frank.ligthart@shi-g.com

www.shi-g.com

**SUMMARY**

SFW's Circulating Fluidised Bed (CFB) technology can be operated in an oxygen-rich environment allowing the highly efficient recovery of heat and power. This produces a concentrated CO<sub>2</sub> stream readily available for capture purposes rather than the typical flue gas emitted.

By replacing air in typical energy generation units with oxygen and recirculated CO<sub>2</sub> rich gas, capturing carbon becomes part of the integrated energy production step. The integrated approach leads to significant reduction in energy penalty typically required with capturing CO<sub>2</sub> from diluted flue gas.

**BENEFITS**

- Wide applicability to solid, gas and liquid fuels as well as cofiring in multifuel plants
- Commercially available solution
- Increases operational flexibility of energy generation asset
- Efficient energy production, higher fuel capacity than in similar sized air-fired units
- Low energy penalty for full oxyfuel BECCS plant 1.5 - 1.7 GJ/tCO<sub>2</sub>
- Oxygen synergy and sector coupling with green hydrogen and Power to X (P2X) plants
- New builds for optimised Oxyfuel performance reduce equipment sizing



30 MWth SFW Oxy+ plant in Ponferrada, Spain: Carbon capture and storage demonstration plant with Endesa and CIUDEN during 2009-2017. Design for a full scale 300 MWe plant was developed as part of the project.

**KEY DATA**

TRL	8	Capture Rate Range (tpd)	>250	Modular (Y/N)	Yes
Source CO <sub>2</sub> Concentration	N/A	Energy Consumption (GJ/tCO <sub>2</sub> )	1.5 - 1.7 <sup>1</sup>	Capture Efficiency (%)	> 99.9% Oxyfuel boiler, 95% from integrated plant
Number of Commercial Plants	1	Number of Pilot Plants	~	Source of Energy for Carbon Capture	Electricity
Target Industries	Biomass and Waste to Energy, Chemicals and E-fuels plants.				

<sup>1</sup> Including O<sub>2</sub> production plant and CO<sub>2</sub> final handling

**TECHNOLOGY DESCRIPTION**

SFW Oxy+ is a mature and robust technology based on commercially proven equipment. When used in plants firing carbon neutral fuels, including biomass, residues, and waste, Oxyfuel leads to overall negative carbon emissions or the production of biogenic and sustainably sourced CO<sub>2</sub> for further synthesis.

The technology was demonstrated at a 30 MWth facility in the Fundacion Ciudad de la Energia (CIUDEN), Spain during the 2010s, accumulating thousands of operational hours under various operating conditions. Subsequently, commercial development with partners led to the completion of FEED activities and development of a readily available 300 MWe Oxyfuel power plant design. SFW's engineering and R&D experts have continued to develop the solution and adapt innovations into the delivery of new carbon negative plant designs.

Oxyfuel applied in circulating fluidised beds (CFBs) allows capturing carbon and taking full advantage of the efficient circulation and management of solids and gases. Beside the fuel flexibility, CFBs hydrodynamics enable different fluidising gas regimes, switching between air and oxyfuel mode or different oxygen enrichment levels while maintaining elevated performance of energy generation.

SFW Oxy+ can be applied as a retrofit in existing CFB plants or as part of a new build project. The technology allows sector coupling and industrial synergy, whereas by-product oxygen from hydrogen electrolysis can be utilised reducing production costs for both capturing carbon and the further synthesis of green chemicals, fuels and materials.

**FEATURED PROJECT**

**30 MWth Oxyfuel plant in Ponferrada, Spain**

SFW realised a carbon capture demonstration plant in cooperation with Endesa and CIUDEN during 2009-2017 (see picture left). SFW's ongoing project development activities in close collaboration with industrial partners aims for commercial operation starting from 2026 for Oxyfuel fired biomass and energy from waste plants.

- No additional OPEX related to solvent procurement and waste disposal
- Can be applied as part of a post-combustion capture solution such as Calcium looping (CaL)

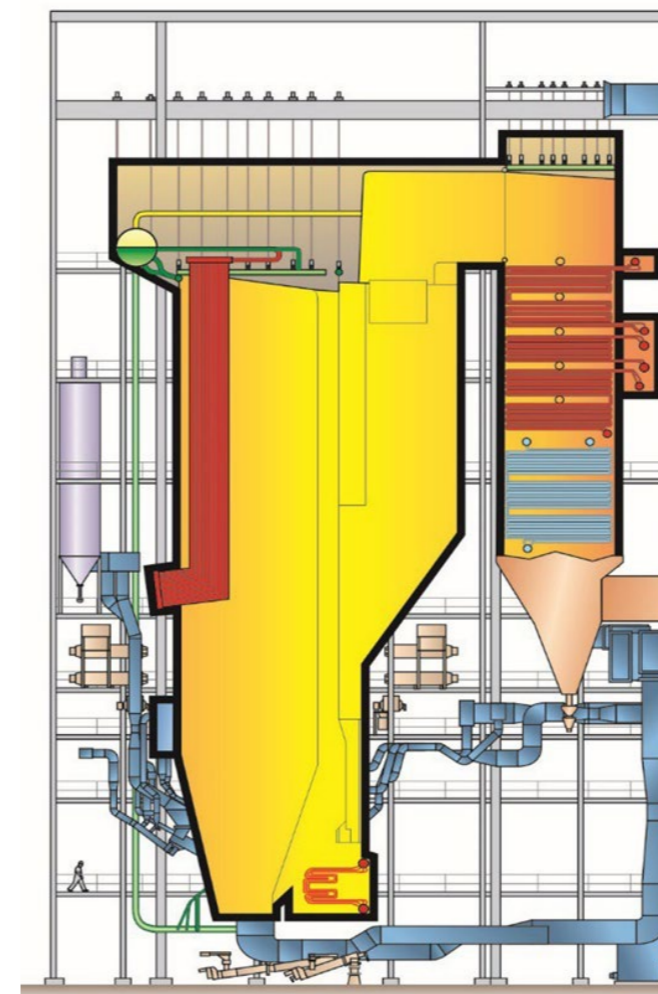

Schematic of SFW fluidised bed solutions. Source (Sumitomo SHI FW)

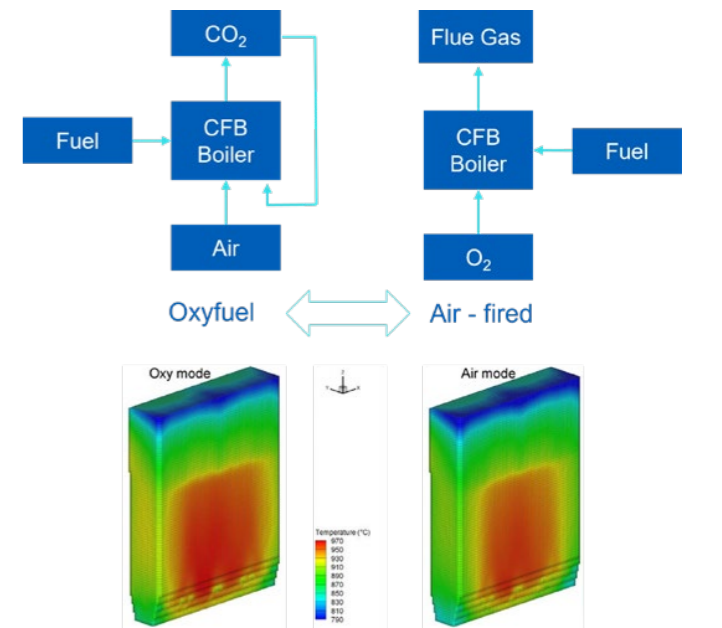

Gas composition and heat flux ratio in SFW fluidised bed solution in both Air fired and Oxyfuel operation. Source (Sumitomo SHI FW)



[sales@svanteinc.com](mailto:sales@svanteinc.com)

[www.svanteinc.com](http://www.svanteinc.com)

**SUMMARY**

Svante Technologies Inc. (Svante) is a leading carbon capture and removal solutions provider, providing solid sorbent-based filter technology for both post-combustion industrial carbon capture as well as direct air capture. This article focuses on Svante’s post-combustion capture technology.

Capturing of CO<sub>2</sub> from industrial operations using chemical solvents is technically proven, but the costs in terms of capital and energy use are high and the potential for toxic chemical emissions has prompted developers to seek alternative solutions. Svante Technologies Inc. (Svante) leverages solid sorbent-based filters and a unique capture process to trap large-scale CO<sub>2</sub> emissions from hard-to-abate industries such as pulp & paper, cement, steel, hydrogen, oil & gas, petrochemicals, and more. The CO<sub>2</sub> captured can be either safely stored deep underground or used to make other products. Svante’s post-combustion capture technology is being deployed in the field at pilot scale by industry leaders in the energy and cement manufacturing sectors.

**BENEFITS**

- No toxic nitrosamine emissions – our solid sorbent-based filters are made to be recycled and don’t require any hazardous chemicals.
- Under slight vacuum operations, we can use any available low-grade or waste heat you already have on site. This reduces the heat duty required for carbon capture, minimising and in some cases, eliminating new natural gas production for steam generation.
- Patented rapid temperature swing adsorption process cycle (~ 1 min) responds quickly to intermittent conditions, and there are no additional materials for continuous make-up required. This delivers more flexibility as the system can handle load, start/stop operations with ease.
- Svante consolidates traditional tall capture plant towers into a single rotary adsorption machine at significantly reduced heights – preventing negative community impacts associated with ruined sightlines – making permitting and social license to operate easier.

**KEY PROJECTS**

- **Lafarge CO<sub>2</sub>MENT Pilot Plant Project (1 TPD):** Located at Lafarge Canada’s Richmond Cement Plant in BC, Canada, this pilot plant captures CO<sub>2</sub> from the cement kiln flue gas, and will eventually be used by project partner, Dimensional Energy, to make products such as sustainable aviation fuel.
- **Cenovus Energy (30 TPD):** This pilot plant captures CO<sub>2</sub> from an industrial facility’s NG boiler in Lloydminster, Saskatchewan, Canada.
- **Chevron USA (25 TPD):** Chevron is piloting Svante technology at its Kern River facility in San Joaquin Valley, California, to capture CO<sub>2</sub> from the post combustion of natural gas. The project has received funding from the US Department of Energy (DOE) (project #DE-FE0031944).
- **Delek US (145,000 TPA):** Delek US has been selected by the DOE’s Office of Clean Energy Demonstrations to negotiate a cost-sharing agreement in support of a large-scale Svante CO<sub>2</sub> capture pilot project at its Big Spring refinery in Texas.

**KEY DATA**

TRL	7	Capture Rate Range (tpd)	~	Modular (Y/N)	Yes
Source CO <sub>2</sub> Purity Range	10 - 20%	Energy Consumption (GJ/tCO <sub>2</sub> )	1.9 - 2.8*	Capture Efficiency (%)	>90%
Number of Commercial Plants	0	Number of Pilot Plants	3	CO <sub>2</sub> Product Purity	95%+
Target Industries	Pulp & paper, biomass, oil & gas, hydrogen, lime, steel, cement, petrochemicals, and direct air capture				

\* Fully electrified design

**TECHNOLOGY DESCRIPTION**

Svante’s technology ecosystem is made up of solid nanomaterials called solid sorbents, namely metal-organic frameworks (MOFs), a rotary adsorption machine (contactor), and structured adsorbent beds (filters), which are housed inside the contactor. The contactor employs Svante’s patented rapid temperature swing adsorption (RTSA) process, which captures diluted CO<sub>2</sub> from post combustion industrial flue gas, concentrates it to 95% purity, and releases it for safe storage or use. This cycle takes less than 60 seconds.

Svante’s RTSA process consists of a series of steps which include passing flue gas, regenerating steam, and conditioning air through filters in a specific order, as follows:

- 1. Adsorption:** The first step in the process is the introduction of the feed gas into the filters, where CO<sub>2</sub> is adsorbed onto the surface of the adsorbent, while the remainder of the flue gas, mainly N<sub>2</sub>, O<sub>2</sub> and H<sub>2</sub>O, is sent to the stack as spent/exhaust gas.
- 2. Regeneration:** The CO<sub>2</sub>-rich filters then rotate to the next process step where low-pressure steam flows through them, requiring only a small amount of superheat to overcome heat losses from the system. This is the first regeneration step, where steam regenerates the adsorbent on the filters, releasing a stream composed primarily of CO<sub>2</sub> and steam.
- 3. Conditioning:** After regeneration with steam, the filters rotate through to the next process where heated ambient air is used to condition and cool them. The ambient air stream, termed Conditioning Gas, removes most of the water vapor from the adsorbent.

**Where does this process cycle take place?**

The adsorption, regeneration, and conditioning functions described above are integrated and implemented in the rotary adsorption machine (contactor), as shown in Figure 1. The technology is integrated into a Svante carbon capture plant (balance of plant included) and can be retrofitted to new and existing industrial facilities.

**COMMERCIAL-SCALE MANUFACTURING CAPACITY**

Svante’s world-class commercial filter manufacturing facility, The Centre of Excellence for Carbon Capture & Removal, in Vancouver, Canada, will have the capacity to manufacture enough filters to capture 10 million tonnes of CO<sub>2</sub> annually starting in the first half of 2025.

Svante is on the *2024 Global Cleantech 100* and was ranked second among private companies in the Corporate Knights *Future 50 Fastest-Growing Sustainable Companies in Canada*. Svante was also acknowledged in the *2023 XB100*, the definitive ranking of the world’s top 100 private deep tech companies, hosted by XPRIZE and Bessemer Venture Partners.

For more information about Svante, visit [svanteinc.com](http://svanteinc.com).

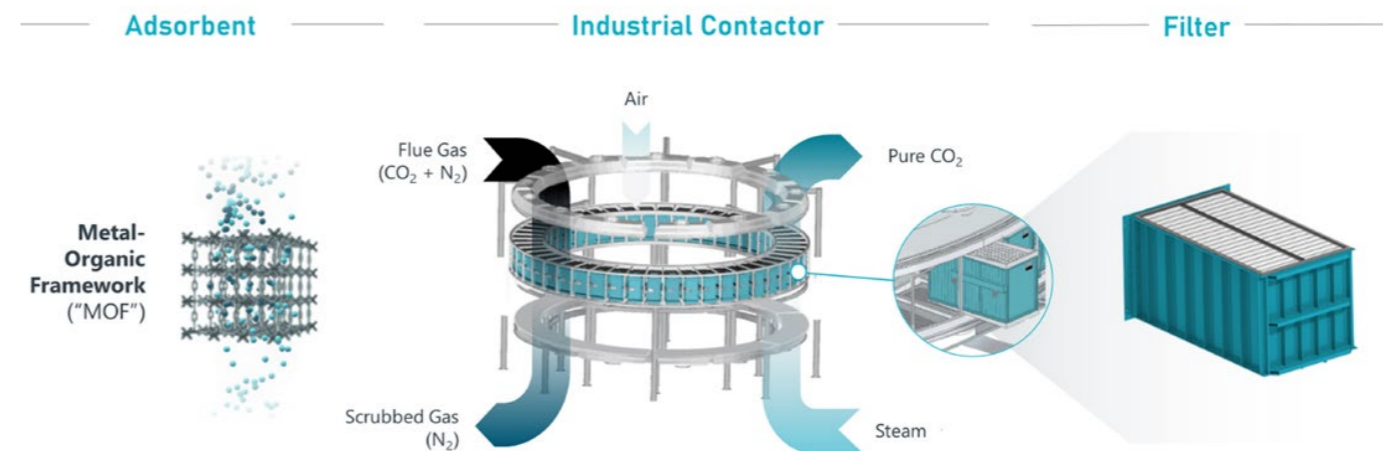



# VACUUM ASSISTED CALCIUM LOOPING (V-CAL)

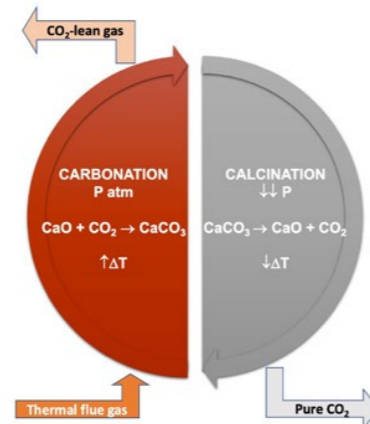

[jmanzano@tecnicasreunidas.es](mailto:jmanzano@tecnicasreunidas.es)

[www.tecnicasreunidas.es](http://www.tecnicasreunidas.es)

## SUMMARY

Vacuum-assisted Calcium Looping is a disruptive technology for CO<sub>2</sub> capture from industrial emissions of a wide range of characteristics. It is based on a fixed-bed reactor filled with calcium oxide, which undergoes carbonation-calcination cycles to capture the carbon dioxide from the flue gas and release it with a purity of ~100%.

The innovation with respect to traditional Calcium Looping is that the calcination step is realised under close-to-vacuum conditions to free the CO<sub>2</sub>, which provides considerable energy savings. Indeed, if the technology is applied to flue gas with temperatures above approx. 700 °C, no external heat is required in any step of the cycles. V-CaL technology reveals particular benefits that are highly suitable for energy-intensive, hard-to-abate industries and can be adapted to treat a large range of flue volumes.

## BENEFITS

- It is low cost: the technology uses CaO as feedstock, which is an easily accessible, cheap material, and the whole process occurs in an uncomplicated fixed-bed reactor with a simple balance of plant.
- It is highly energy efficient: Limited energy in terms of heat, electricity or any other source is required in the regeneration of the material to produce a CO<sub>2</sub> with a purity close to 100%.
- It is easily scalable: V-CaL is a modular technology that can be easily scaled-up to increase carbon capture capacity.
- It simply integrated: a V-CaL solution to remove carbon from a flue source does not require a radical change of the industrial facility and can be easily implemented without major operational disruption materials.
- It is sustainable and non-hazardous: V-CaL is not dependent on toxic, corrosive or expensive materials.

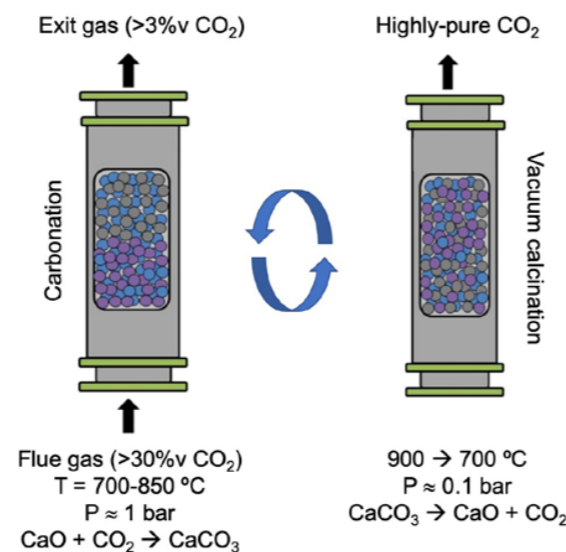

## KEY DATA

TRL	5	Capture Rate Range (tpd)	>92%	Modular (Y/N)	Yes
Source CO <sub>2</sub> Purity Range	>5%	Energy Consumption (GJ/tCO <sub>2</sub> )	~	Capture Efficiency (%)	~
Number of Commercial Plants	0	Number of Pilot Plants	1	Purity CO <sub>2</sub> produced	>99%
Target Industries	Any intensive industry, mainly cement, ceramic, steel, textile and other metal, power generation, natural gas combined cycle				

## TECHNOLOGY DESCRIPTION

Calcium Looping (CaL) represents an emerging CO<sub>2</sub> capture technology that employs solid looping cycles at elevated temperatures and utilises CaO as a CO<sub>2</sub> sorbent. CaL offers several advantages over established CCS technologies, including reduced costs and energy penalties associated with CO<sub>2</sub> capture, a high availability of calcium-based sorbents, and potential synergy with energy-intensive industries like cement and steelmaking plants. CaL systems have been extensively studied in configurations comprising interconnected fluidised beds. However, the purity of CO<sub>2</sub> is of critical importance in CaL systems, as impurities such as dust, O<sub>2</sub> from oxy-calcination, traces of SO<sub>2</sub> from oxy-calciner, or H<sub>2</sub>O can significantly impact purification, costs, and applicability.

In the innovative Vacuum Calcium Looping (V-CaL) process, which Tecnicas Reunidas is currently developing and has recently filed for patent, the production of extremely high purity CO<sub>2</sub> is achievable (i.e., virtually pure CO<sub>2</sub>). In the V-CaL process, the exothermic decarbonisation of flue gases by CaO carbonation takes place in a single packed bed at approximately 700 °C. The use of a packed bed eliminates the need for dust-cleaning equipment. Subsequently, when the bed is hot and saturated with CaCO<sub>3</sub>, the application of a partial pressure swing of CO<sub>2</sub> (to reach partial pressures of CO<sub>2</sub> around 0.1 atm) induces the calcination of CaCO<sub>3</sub> and the adiabatic cooling of the solids, returning them to the initial temperature. Owing to the endothermic calcination step and the use of vacuum, no external energy input is required, unlike other CaL systems (i.e., lime and cement, with >4GJ/t CO<sub>2</sub>). As the calcination proceeds, pure CO<sub>2</sub> is the only gas evolving from the decomposing CaCO<sub>3</sub>, with traces of other gases (i.e., inert gases <<0.1% and SO<sub>2</sub> evolved from the decomposition of CaSO<sub>4</sub>, which does not exceed 0.1 ppmv as limited by equilibrium).

Due to its operational conditions, the V-CaL can be directly integrated into various high-temperature off-gas industrial sources that cannot be fully decarbonised, such as metallurgical processes with electric-arc furnaces or the cement industry. Additionally, it can be easily implemented in current energy power plants with CO<sub>2</sub> emissions.

This technology has been developed in close collaboration with the Carbon Science and Technology Institute (INCAR) of the Spanish Council for Scientific Research (CSIC).

# To accelerate the deployment of carbon capture and storage (CCS) globally.

## MEMBERSHIP

The Global CCS Institute is an international think tank and world leading authority on carbon capture and storage (CCS) – a vital technology in tackling climate change and providing energy security.

Our diverse international membership includes governments, global corporations, private companies, research bodies and non-governmental organisations.

Working with, and on behalf of our members, we drive the adoption of CCS as quickly and cost effectively as possible by:

- Sharing expertise
- Building capacity
- Providing advice and support

Together, we are committed to CCS as an integral part of a net-zero emissions future.

By joining the Institute, members will have:

- Peerless access to the latest national and international information on CCS
- Professional consultancy services across every aspect of the CCS value-chain
- Connections to networks which span the highest levels of social, environmental and economic decision-making

We are committed to ensuring that our members are the best informed and are most effectively able to address any issue in the CCS space.



Scan the QR code to find out more about membership.

CONTACT  
STAY CONNECTED



globalccsinstitute.com

The Global CCS Institute is headquartered in Melbourne, Australia with offices in Abu Dhabi, Beijing, Brussels, London, Tokyo and Washington DC.



AIRHIVE

## DIRECT AIR CAPTURE (DAC)

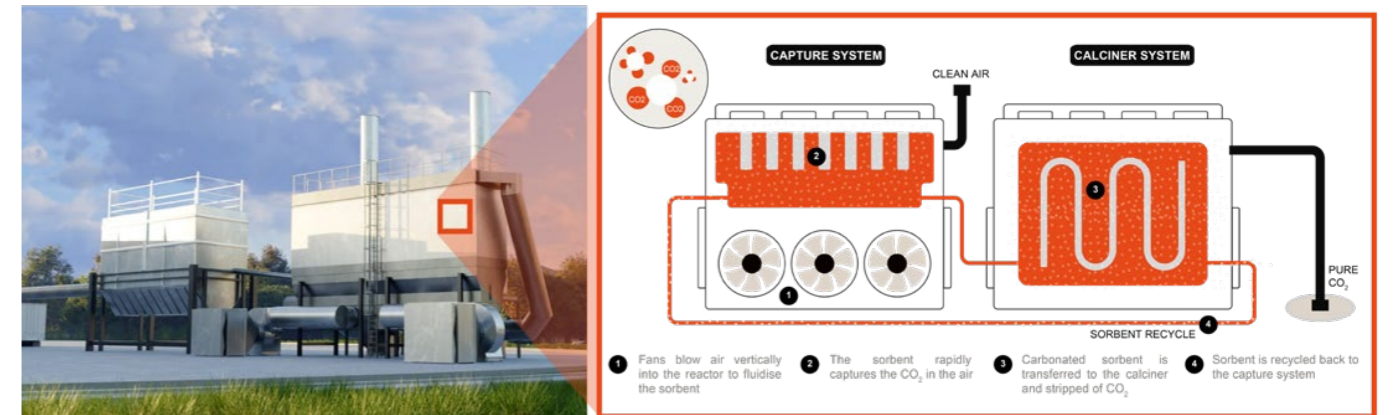

hello@airhive.earth

www.airhive.earth

## SUMMARY

Direct Air Capture (DAC) is an innovative technology designed to mitigate the rising levels of atmospheric CO<sub>2</sub> by capturing it directly from the air. Airhive is developing a fast, energy efficient and low-cost DAC technology that will rapidly scale to accelerate the deployment of carbon capture. Airhive's technology employs fluidisation to provide rapid CO<sub>2</sub> removal via our low-cost, non-toxic metal oxide-based sorbent. Our approach is designed for rapid scalability by (i) leveraging proven industrial processes, (ii) minimising energy requirements, and (iii) employing abundant, sustainable sorbents. The technology consists of a horizontal fluidised bed reactor where particles of mineral-based sorbent mix rapidly with fluidising air to capture CO<sub>2</sub>, resulting in CO<sub>2</sub>-free air exiting the reactor. The carbonated solids are then circulated into a connected electro-calciner, where it is regenerated, yielding pure CO<sub>2</sub> for utilisation or storage and refreshed sorbent for successive cycles of carbon capture.

## BENEFITS

The Airhive DAC system is:

- **Fast:** The nano-structured sorbent removes 99% of CO<sub>2</sub> from the air in <0.1 seconds and fully saturates in under three hours.
- **Sustainable and easy to scale:** The technology is built on existing industrial equipment and supply chains, configured in new ways for DAC. The naturally abundant mineral sorbent is widely available, non-toxic and can be reused for many cycles of carbon removal.
- **Low-cost:** Estimated cost at pilot scale is <\$379 per net tCO<sub>2</sub> with pathways to estimate at-scale costs of \$93 per net tCO<sub>2</sub>.
- **Energy efficient:** The system is targeted at 1.5 MWh/tCO<sub>2</sub>, and can be fully powered by low carbon energy. It also has in-built thermochemical energy storage potential, allowing it to run when there is no external energy source available.

## KEY PROJECTS

Airhive is launching 3 pilots in 2024:

- **TENET:** Government-funded 60 tCO<sub>2</sub> pilot plant in Teesside, UK.
- **Deep Sky:** Commercial 1,000 tCO<sub>2</sub> pilot partnership, including geological CO<sub>2</sub> storage.
- **CCEP:** Commercial 1,000 tCO<sub>2</sub> pilot with Coca-Cola for a first utilisation in carbonated beverages.

Airhive is conducting feasibility studies for multiple commercial facilities (up to 250 ktpa scale) in the UK, US and Canada to come online 2025-29.

## KEY DATA

TRL	6	Capture Rate Range (tpd)	3.8 tpd/reactor	Modular (Y/N)	Yes
Source CO <sub>2</sub> Purity Range	~	Energy Consumption (GJ/tCO <sub>2</sub> )	3.6 (1 MWh/tCO <sub>2</sub> )	Capture Efficiency (%)	99%
Number of Commercial Plants	0	Number of Pilot Plants	3 (2 commercial)		
Target Industries	Chemicals, Food and Beverage, Green Fuels, CDR credit buyers				



membranes@ardenttechnologies.com

www.ardenttechnologies.com

**SUMMARY**

Advanced membrane technologies hold the key to making CO<sub>2</sub> capture manageable at large and small scale, through low-energy, low-cost separation. Founded in 1993, Ardent specialises in the development and commercialisation of novel membrane technologies and currently ships over 1,000 units per year across multiple applications. Ardent's field-proven Optiper™ platform technology was developed to enable near-term industrial decarbonisation. The technology exploits a mass-transfer mechanism known as facilitated transport where active elements in the membrane allow for the selective transfer of CO<sub>2</sub> molecules enabling a high flux, low-pressure separation, thus reducing CAPEX and OPEX. The technology was recently deployed in the field in multiple carbon capture applications including in steel, kiln and petrochemical use cases. Ardent works with leading companies across the carbon value chain to deliver end-to-end solutions and is backed by key strategic partners including Chevron Technology Ventures, Technip Energies and Syensqo.

**BENEFITS**

- **Low Cost, Even At Small Scale** The modular nature of Optiper™ membranes enables a low cost of capture, even at small scale, where traditional technologies cannot compete.
- **Solvent Free, Fully Electrified** The Optiper™ technology offers a chemicals-free capture solution for customers that don't have access to steam or water or want to avoid the permitting, HS&E and emissions issues associated with solvents.
- **Low Energy, Low Footprint** The highly efficient nature of the technology enables low pressure operation, thus reducing the compression needs and energy consumption by up to 40%. This enables a reduction in overall cost of capture and in system footprint.
- **Hybrid Solutions** Ardent has expertise in designing optimised hybrid systems that combine Optiper™ with other process technologies to meet the needs of different facilities. For example, Ardent's Optiper™ membranes can be combined with cryogenics to deliver high purity (99.8%+) CO<sub>2</sub> at conditions ready for transport.

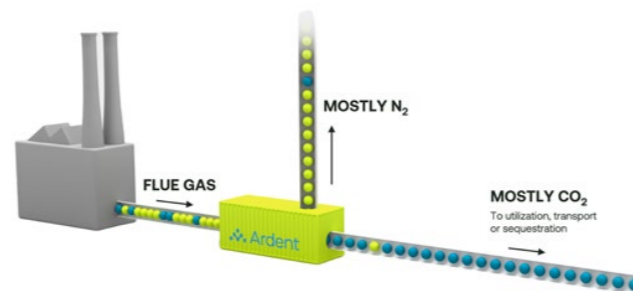

**KEY DATA**

TRL	6	Capture Rate Range (tpd)	1 - 1,000+	Modular (Y/N)	Yes
Source CO <sub>2</sub> Purity Range	3 - 30%+	Energy Consumption (GJ/tCO <sub>2</sub> )	1.0 - 3.2	Capture Efficiency (%)	90 - 95%
Number of Commercial Plants	0	Number of Pilot Plants	4		
Target Industries	Cement / Kiln, Steel, Oil and Gas / Petchem, Pulp & Paper, Waste to Energy, Glass				

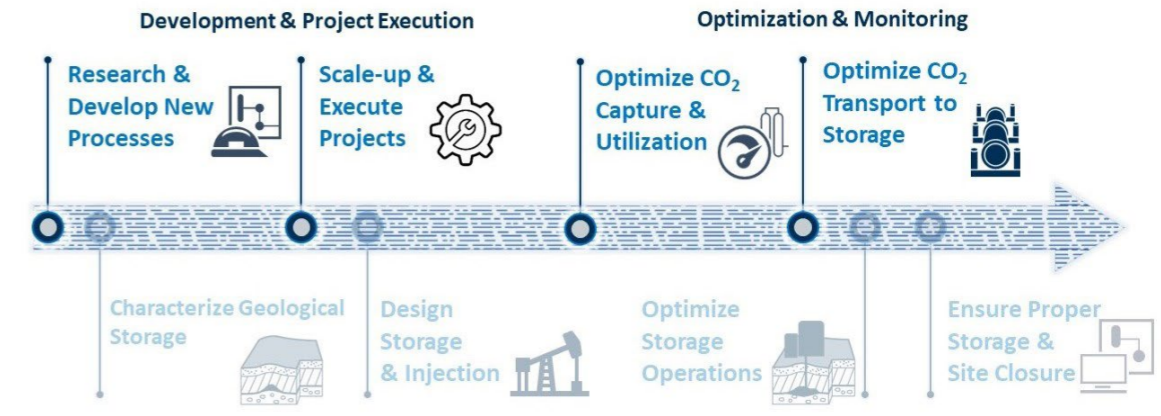

gerardo.munoz@aspentech.com

www.aspentech.com

**SUMMARY**

AspenTech is an industrial software company with over 40 years of history in innovation, and a digital portfolio that provides a comprehensive, holistic approach to asset optimisation and process decarbonisation across design, operations and maintenance. Throughout the CCUS value chain and across the asset lifecycle, AspenTech combines the power of AI with our domain expertise to support the development of scalable carbon capture and carbon storage solutions, prioritise investment decisions, improve efficiencies and have visibility across all stages of the value chain.

Digital technologies applied to carbon capture and removal, transportation, and storage, enable ongoing innovation, rapid scaling, and increased confidence in geological CO<sub>2</sub> storage. The powerful combination of AspenTech solutions and an Industrial AI approach for process simulation and optimisation, subsurface geophysical and geological modelling and digital grid management, deliver performance breakthroughs at scale—both economically and at an accelerated pace, to meet the requirements of industrial carbon mitigation.

**BENEFITS**

- Drive innovation in the development of new carbon capture and carbon removal technologies
- Evaluate risk in CCS projects to make informed decisions across the value chain, including capture technologies and processes selection, and prioritising investments
- Assess technical and economic feasibility and reduce capital and operational expenditures in carbon capture processes with rigorous process simulation
- Accelerate cost-effective commercialisation and scale-up of carbon capture processes with optimised process designs
- Maximise energy efficiency and process stability, optimising operations and ensuring safety, with advanced process control and digital guidance for enhanced decision-making
- Improve reliability, safety and efficiency in carbon capture, transport and compression operations

**KEY AREAS**

- **Techno-Economics:** Well-known process simulators Aspen Plus® and Aspen HYSYS® help to further optimise processes, identifying right trade-offs between capture efficiency and energy use.
- **Investment Certainty:** Dynamic, event-driven modelling with Aspen Fidelis™ guides investment and operational decisions to maximise profits across the lifecycle while identifying uncertainties and bottlenecks to mitigate financial risks.
- **Project Scale-Up And Execution:** Model-based cost estimation provides insights to rapidly define scale, size and economic feasibility. AspenTech's concurrent engineering workflows accelerate project development by improving collaboration between stakeholders.
- **Carbon Capture Operations:** Advanced process control technologies such as Aspen DMC3, improve the process stability and reduce energy use in key unit operations. Design models can be used to train operators and improve operational decisions.

**KEY DATA**

TRL	9
-----	---



## MUF-16 ADSORBENT



✉ [shane@captivatetechnology.com](mailto:shane@captivatetechnology.com)

🔗 [www.captivatetechnology.com](http://www.captivatetechnology.com)

### SUMMARY

The team at Captivate Technology has developed a porous, solid-state material that acts as a sponge for carbon dioxide. This novel metal-organic framework (MOF), named MUF-16, has the potential to significantly reduce greenhouse gas emissions through the sieving of CO<sub>2</sub> from industrial flue gases using pressure-swing adsorption. The process is continuous and recyclable, generating a continuous stream of carbon dioxide to be stored or used. MUF-16 is low-cost, stable to all impurities, and has a long lifetime. Captivate is rapidly moving to pilot and demonstration scales in collaboration with partners and end-users. Ultimately, our vision is to produce capture units that will remove CO<sub>2</sub> from industrial emissions on the gigaton scale to deliver substantial environmental and economic benefits. MUF-16 will couple CO<sub>2</sub> capture to its value-added deployment as industry pivots away from viewing carbon dioxide as a waste by-product toward it being valuable raw material.

### BENEFITS

- Robust and inexpensive solid-state adsorbent
- High selectivity for CO<sub>2</sub> over other gases such as nitrogen and methane
- Tolerant of impurities such as water vapour acid gases with no unwanted side-reactions
- Low energy penalty for CO<sub>2</sub> desorption and recycling due to weak physisorption interactions
- Short cycles times are possible owing to the rapid uptake and release kinetics
- Compatible with conventional pressure-swing adsorption processes
- Spent adsorbent easily regenerated at its end-of-life
- Applicable to flue gases, cement manufacturing, natural gas and biogas purification etc
- Maintains carbon capture performance with humid gas streams.

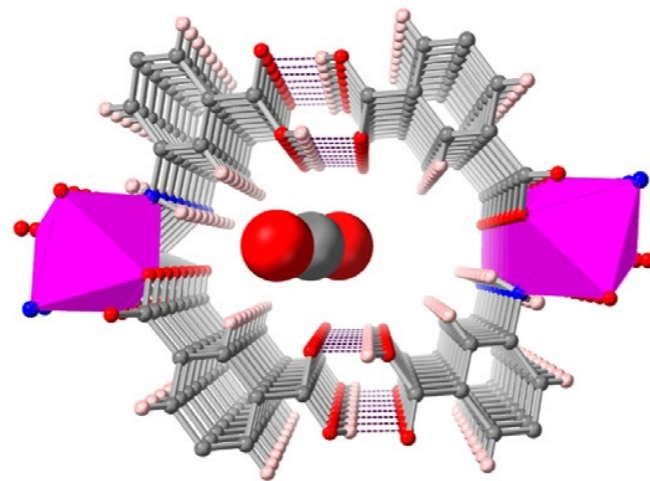

### KEY DATA

TRL	5	Capture Rate Range (tpd)	1 - 1,000	Modular (Y/N)	Yes
Source CO <sub>2</sub> Purity Range	>4%	Energy Consumption (GJ/tCO <sub>2</sub> )	<1.1	Capture Efficiency (%)	>95%
Number of Commercial Plants	0	Number of Pilot Plants	1	CO <sub>2</sub> selectivity over N <sub>2</sub> & CH <sub>4</sub>	High
Target Industries	Fossil combustion, cement, geothermal, SMR, biogas, syngas, built environment, gas-fired engines and turbines				



## DIRECT OCEAN CAPTURE

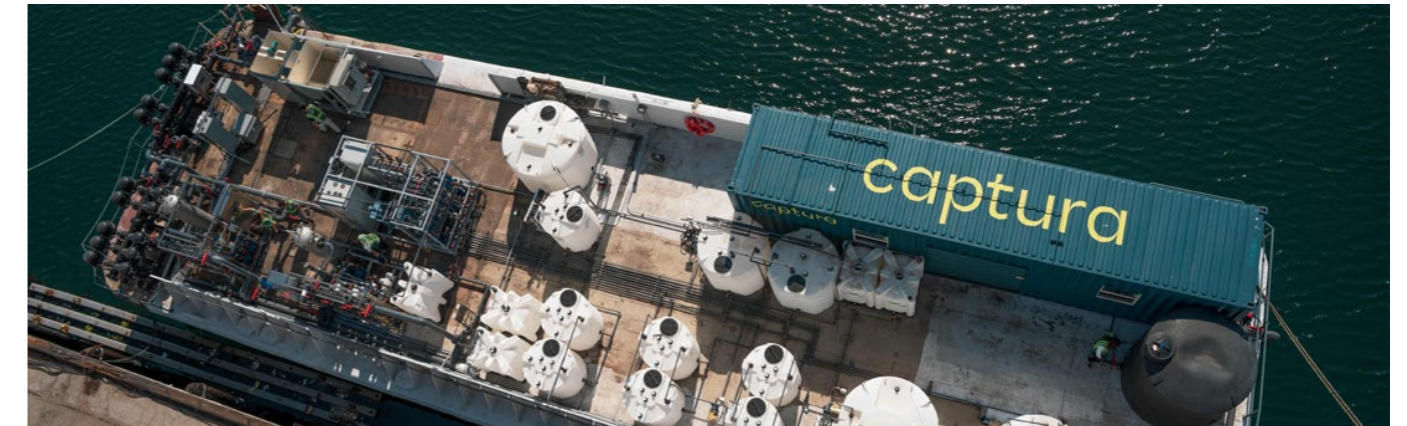

✉ [info@capturacorp.com](mailto:info@capturacorp.com)

🔗 [www.capturacorp.com](http://www.capturacorp.com)

### SUMMARY

Captura's solution harnesses the greatest, existing carbon removal device on the planet – the ocean. The ocean covers ~71% of the earth's surface and absorbs ~30% of CO<sub>2</sub> emissions as part of a natural equilibrium with the atmosphere. Captura has developed an innovative electrochemical technology, called Direct Ocean Capture (DOC), that amplifies the ocean's natural ability to drawdown excess CO<sub>2</sub> from the atmosphere, while prioritising ocean health. With only seawater and renewable energy as inputs, Captura's technology removes a measurable stream of CO<sub>2</sub> directly from the upper ocean that subsequently will be either sequestered or utilised. Decarbonised seawater is then returned to the ocean with the regenerated capacity to absorb CO<sub>2</sub> from the atmosphere. The process creates no by-products and adds nothing new to the ocean. By leveraging the ocean's natural processes to remove CO<sub>2</sub> from the atmosphere, DOC has significant potential as a low-cost and highly scalable carbon removal solution.

### BENEFITS

- **Cost-Effective:** Utilising the ocean's natural processes to remove atmospheric CO<sub>2</sub> reduces capital costs significantly. Captura's DOC requires no chemical inputs and avoids the cost of making, regenerating & disposing of absorbents. It can also make use of off-peak, intermittent renewable electricity.
- **Scalability:** Captura's technology is deployable virtually anywhere there is access to the ocean. It requires no precious/rare-Earth elements as inputs, and produces no by-products that require disposal at large scale.
- **Ocean Health:** Captura's approach uses no external chemicals and adds no new materials to the ocean. The process returns CO<sub>2</sub>-depleted seawater with a slightly lower acidity to the ocean, which has the potential co-benefit of counteracting local ocean acidification before removing CO<sub>2</sub> from the atmosphere.
- **Utilisation:** Captura's process produces a measurable and verifiable stream of CO<sub>2</sub> that can be safely and securely stored to generate high-quality carbon credits. Alternatively, the CO<sub>2</sub> can be used to produce sustainable products, like low carbon intensity fuel.

### KEY PROJECTS

**Pilot One:** Captura's first pilot system, with a one-ton-per-year capture capacity, launched operations in Newport Beach, CA in August 2022.

**Pilot Two:** Located at AltaSea at the Port of Los Angeles, Captura's second pilot plant began end-to-end ocean operations in October 2023. It has the capacity to capture 100 tons of CO<sub>2</sub> annually and provides an ocean-based site for technology development and ocean impact monitoring.

**Pilot Three:** Captura and Equinor have partnered to deploy a 1000-ton-per-year pilot plant with multinational energy company Equinor, serving as a launchpad to build large-scale, commercial plants.

### KEY DATA

TRL	6	Capture Rate Range (tpd)	~	Modular (Y/N)	Yes
Source CO <sub>2</sub> Purity Range	~	Energy Consumption (GJ/tCO <sub>2</sub> )	~	Capture Efficiency (%)	>90% expected
Number of Commercial Plants	0	Number of Pilot Plants	3		
Target Industries	Any entities with Net Zero targets, large corporations, especially hard-to-abate sectors (e.g., aviation, shipping, steel, and cement)				

# CARBONCO POST-COMBUSTION CARBON CAPTURE

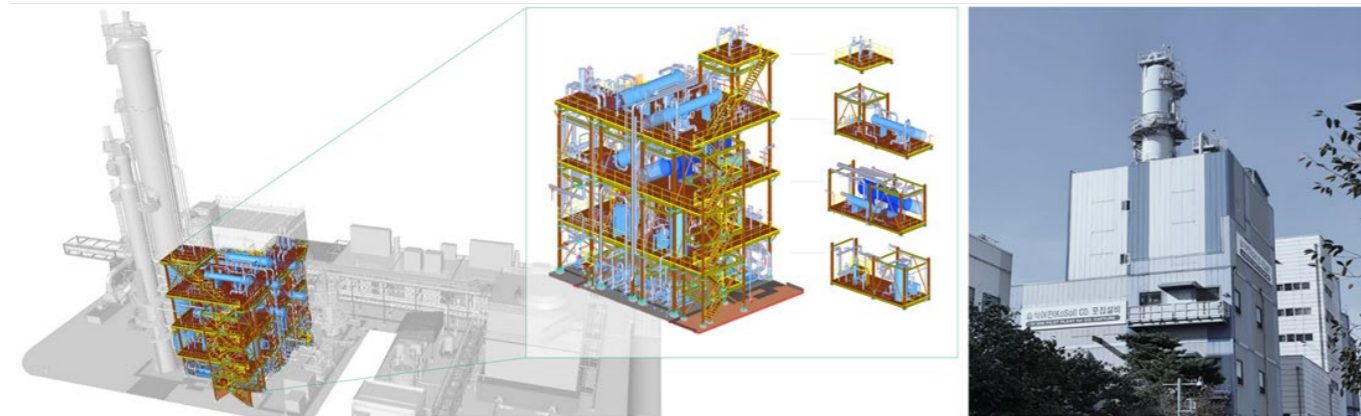

[inquiry@carbonco.com](mailto:inquiry@carbonco.com)

[www.carbonco.com](http://www.carbonco.com)

## SUMMARY

CARBONCO is a pioneering company at the forefront of mitigating the greenhouse gas emissions through innovative carbon capture solvent and expertise in engineering design, procurement, construction, commissioning and operation. With the core strength in Post-Combustion Carbon Capture (PCCC) technology, CARBONCO offers customised and affordable design tailored to diverse industrial settings. Our expertise lies in developing CCUS systems that seamlessly integrate into existing infrastructure, ensuring maximum efficiency and minimal disruption.

One of CARBONCO's standout features is engineering technology with its amine-based solvent. This offers unmatched efficiency in capturing carbon dioxide from industrial processes, enabling significant reduction. CARBONCO's technology is not only highly effective but also eco-conscious, adhering to stringent sustainability standards.

By combining the cutting-edge engineering with state-of-the-art solvent technology, CARBONCO is revolutionising the CCUS landscape, providing sustainable solutions that empower industries to combat climate change effectively. Advancing towards carbon neutrality, CARBONCO continues to revolutionise CCUS technology, setting new standards for sustainability.

## BENEFITS

- Advanced carbon capture technology co-developed with Korea Electric Power Research Institute (KEPRI) at the national level
- Proven technology with commercial plant in continuous operation over 10 years
- Grap-and-go solutions standardised and optimised for various industries with flue gases in wide range
- Low energy achieving >90% recovery rate and 99.9%+ purity tailored to the customer's demand
- Module turnkey design and solutions for both small and large scale carbon capture plants
- All-inclusive services from decarbonisation consulting to feasibility study, FEED, EPC and O&M
- Reduction of energy consumption through continuous process innovation ( $\leq 2.3\text{GJ}$  per tonne  $\text{CO}_2$ )

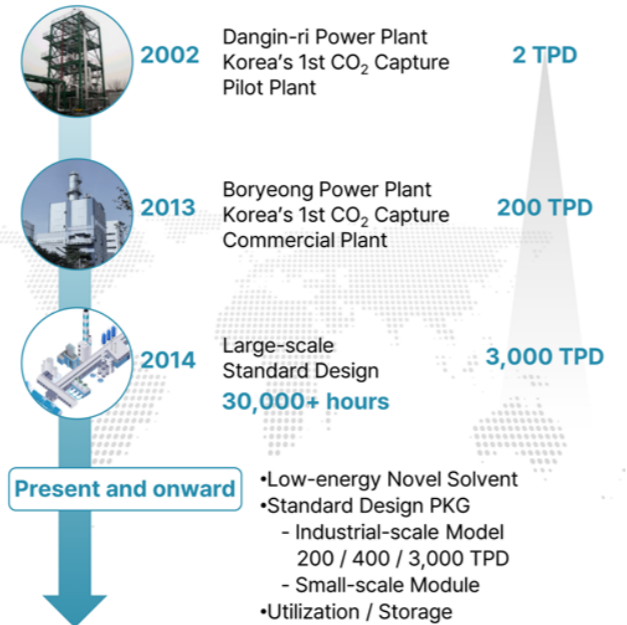

## KEY DATA

TRL	9	Capture Rate Range (tpd)	~	Modular (Y/N)	Yes
Source $\text{CO}_2$ Purity Range	Over 3%	Energy Consumption (GJ/t $\text{CO}_2$ )	<2.3	Capture Efficiency (%)	Over 90%
Number of Commercial Plants	1	Number of Pilot Plants	1	Feed Gas $\text{O}_2$	~
Target Industries	Oil & Gas, Power Plant, Petrochemical, Waste-to-Energy, Cement, Steel, Glass & Chemicals				

# CarbonOrO CARBON CAPTURE

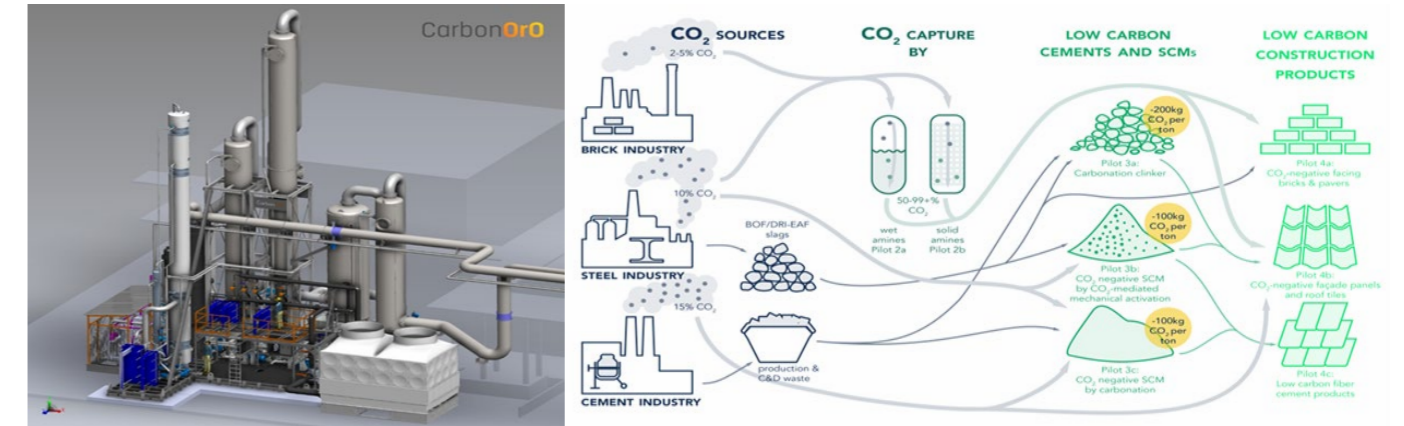

[info@carbonoro.com](mailto:info@carbonoro.com)

[www.carbonoro.com](http://www.carbonoro.com)

## SUMMARY

CarbonOrO delivers post-combustion carbon capture solutions to industrial  $\text{CO}_2$  emitters across industries including waste management, energy, oil & gas, chemicals, steel and cement.

CarbonOrO's proprietary technology uses a unique bi-phasic amine solvent. It was developed with a strong focus on effectiveness in chemical absorption/desorption of  $\text{CO}_2$ , high loading characteristics (small footprint/lower CAPEX), energy efficiency and stability (low degradation). Due to the unique properties of the solvent, desorption of  $\text{CO}_2$  is not just driven by chemistry but also by a physical process (phase-shift).

Traditional solvents release more  $\text{CO}_2$  if temperature is raised in a straightforward chemical process. The CarbonOrO mixture encompasses an effect seen only in bi-phasic solvents:  $\text{CO}_2$  is released in bulk above a threshold temperature ( $70^\circ\text{C}$ ), triggering the phase shift in the solvent.

This allows for desorption of  $\text{CO}_2$  at lower temperatures, with significantly less energy use than existing amine solvents. Applications are for a 5-50% range of  $\text{CO}_2$  emission sources.

## BENEFITS

- The unique properties of the bi-phasic solvent translate into:
  - Low energy consumption from the combined chemical and physical effect. Energy consumption, expressed as 'reboiler duty', is at 2.3-2.6 GJ/t  $\text{CO}_2$ , significantly below the current industry (MEA) benchmark (3.6 GJ/t  $\text{CO}_2$ );
  - Production of  $\text{CO}_2$  at an even increased temperature ( $95-120^\circ\text{C}$ ) with thermal heat will provide  $\text{CO}_2$  at 4-6 bar, which saves up to 20% in electricity costs for compression and liquefaction in downstream  $\text{CO}_2$  transport;
  - Increased solvent lifetime (less degradation) due to low operational temperatures (thermal degradation) and reduced oxidative degradation.
  - Compact units up to 100 kton capacity, delivered on 20 ft container frames, that can be built off-site and in-series to reduce CAPEX and on-site installation. The units are built with off-the-shelf parts from a variety of trusted suppliers.

## KEY DATA

TRL	7	Capture Rate Range (tpd)	~	Modular (Y/N)	Yes
Source $\text{CO}_2$ Purity Range	5 - 50%	Energy Consumption (GJ/t $\text{CO}_2$ )	2.3 - 2.6	Capture Efficiency (%)	>90%
Number of Commercial Plants	0	Number of Pilot Plants	2	Captured $\text{CO}_2$ Purity	>99 mol%
Target Industries	Industries with emissions from post-combustion and energy/oil/gas industries				

## KEY PROJECTS

- AVR Afvalverwerking, the largest Dutch waste company, has entered into a pilot-contract with CarbonOrO to test our technology at their WtE plant in Duiven, the Netherlands. The pilot will focus on 2,000 hours of testing, starting in Q2 2024. AVR was the first company in NW-Europe to realise a CCUS-project (100 kton/yr capacity) and  $\text{CO}_2$  delivered to greenhouses. In its newly designed Mobile Testing Unit (capacity of 10 ktpa, CarbonOrO will incorporate 3 pending patents, focused on reducing amine degradation and energy consumption. The pilot's goal is to demonstrate that the technology/process can capture  $\text{CO}_2$  at industrial scale with significant energy savings, with low amine degradation and emissions.
- CarbonOrO has been awarded an EU-grant with Belgian research institute VITO and steel/brick/cement producers. CarbonOrO will capture  $\text{CO}_2$  for mineral carbonation from waste streams, creating building materials at an industrial site of Vandersanden (brick manufacturer), in Belgium. [www.carbon4minerals.eu](http://www.carbon4minerals.eu)

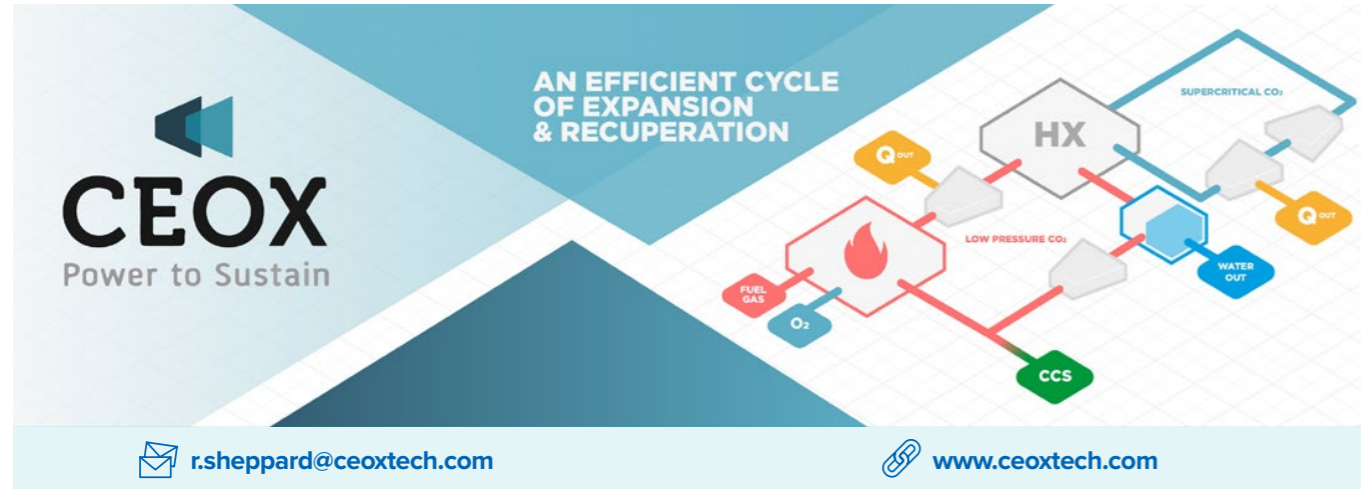

**SUMMARY**

CEOX is a power-with-inherent-capture technology. It uses oxy-combustion with a nested supercritical CO<sub>2</sub> power generation loop. Every element of the CEOX cycle uses fully mature equipment with decades of operational experience. The only new technology is the thermodynamic power generation cycle itself.

CEOX offers emissions-free power generation with 100% inherent capture of CO<sub>2</sub>. The pressurised CO<sub>2</sub> outflow is high-quality and ready for disposal via CCS. Power is generated via a semi-closed combustion loop with CO<sub>2</sub> recycle, nested with a closed supercritical CO<sub>2</sub> loop.

The post-oxy-combustion mix of CO<sub>2</sub> and water is inherently contained at pressure within the process, eliminating the need for CO<sub>2</sub> capture and compression. CEOX has application for any hydrocarbon power and heat generation, where a CCS network is available to dispose of the CO<sub>2</sub>.

**BENEFITS**

- **No new technology:** Its dual pressure design permits the use of proven materials and available equipment, meaning a CEOX system is present day technology ready for implementation now.
- **Emissions free:** CEOX delivers emissions-free industrial power and heat in any application where a CCS network is present to facilitate CO<sub>2</sub> disposal.
- **Efficient:** CEOX uses supercritical CO<sub>2</sub> to generate its power which does >50% more work than steam when converting heat into power. This enables high efficiency, lower cost, and smaller power plants.
- **Low CO<sub>2</sub> capture cost:** CEOX adds value to an industrial process by integrating high availability power with CO<sub>2</sub> capture at no extra cost for capture.
- **Highly Economic:** Efficiency >15% better than industrial normal and still at no extra cost for CO<sub>2</sub> capture.

**KEY PROJECTS**

- **CEOX Concept Basis of Design:** 2017 Thermodynamic modelling, supply chain validation, NIST validation and independently peer reviewed engineering study.
- **Project One:** CEOX is currently in FEED for a 50MWe modular power plant to pave the way for developing a full-scale demonstration plant.

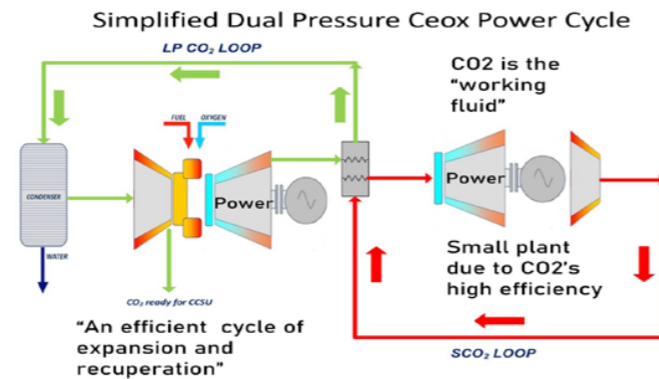

**KEY DATA**

TRL	5	Capture Rate Range (tpd)	700 tpd / 50 MWe	Modular (Y/N)	Yes
Source CO <sub>2</sub> Purity Range	N/A	Energy Consumption (GJ/tCO <sub>2</sub> )	N/A	Capture Efficiency (%)	>99%
Number of Commercial Plants	0	Number of Pilot Plants	0	Cost of Capture	<\$10 /tCO <sub>2</sub>
Target Industries	All thermal industrials incl: LNG, Water desal, Blue H <sub>2</sub> , Ammonia, Methanol, CCS cluster CO <sub>2</sub> compression, Petrochemicals, Oil and Gas process, Direct air capture, SMR, ATR etc.				

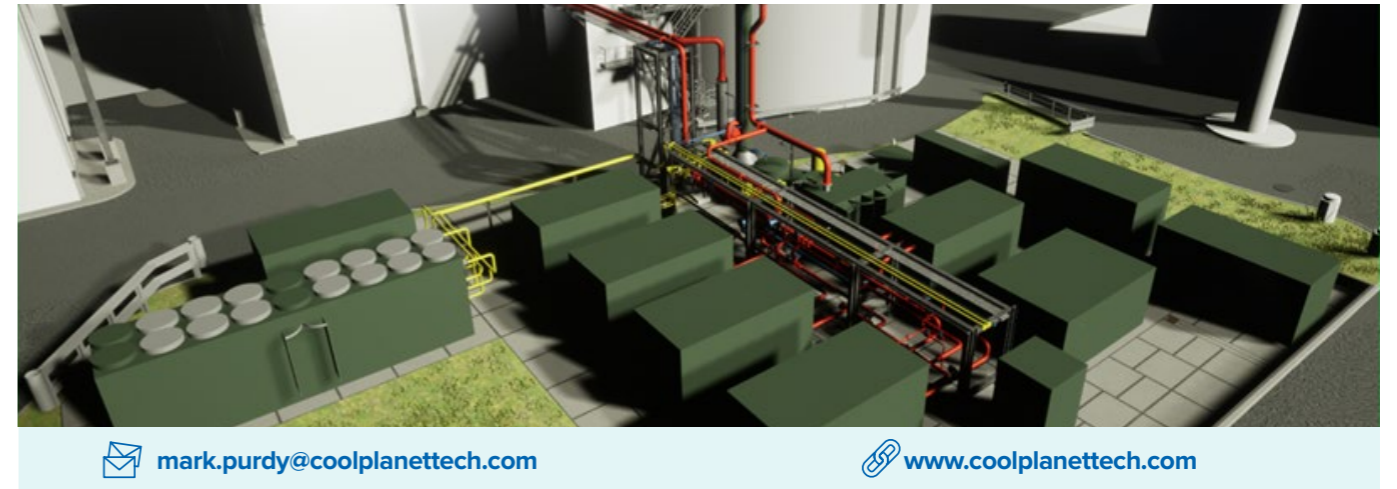

**SUMMARY**

Simple, Scalable, Adaptable, Upgradable Cool Planet Technologies is significantly reducing the cost of carbon capture from industrial flue gas emissions offering the market an easy to install modular, energy efficient membrane-based process ideal for end of pipe retrofits. The compact plant is highly scalable, provides operational flexibility with fast start-up and response times. Cool Planet is collaborating with the Helmholtz Institute and Holcim to up-scale the technology building a 10,000 tpa demonstration plant at Höver, near to Hanover in Germany in 2025 which will be followed by 200,000 tpa and 800,000 tpa plants in 2026 and 2028 respectively. The investors in Cool Planet are Audacy Ventures, ENI, and Neva.

**BENEFITS**

- Cool Planet's proprietary technology has been designed and built from the outset to be scalable and to meet the robust requirements and reliability of heavy industry:
- 50% lower cost per tonne: Intrinsically lower Capex and Opex compared to existing solutions.
- 60% lower energy: Passive process requires less energy
- Highly compact: CPT's technology, as a footprint, is a fraction of the size of existing solutions and has a low profile. Ideal for retrofitting at small sites.
- Proven technology: The product of over 15 years of R & D with three industrial pilots.
- Fully electrical: Can be powered by renewable electricity.
- Chemical free: No harmful emissions.
- Fast start and response: Ideal for intermittent and batch industrial processes.
- Upgradable: Easy to benefit from our continued R&D.

**KEY PROJECTS**

- **Pilot Testing:** Two successful pilots undertaken at EnBW's Rheinhafen-Dampfkraftwerk hard coal-fired power plant as part of the METPORE II and MemKoR projects funded by German government. Successful trial completed in 2022 at Holcim's Höver cement plant in Germany.
- **Membrane Module Demonstration:** Our latest generation scaled up membrane module will be demonstrated and undergo a test programme at Heron's facility in 3Q/4Q 2024. This demonstration will de-risk the scaling and advanced membrane modules.
- **Demonstration Plant:** Cool Planet is currently constructing a Demonstration plant (10,000 tpa) at Holcim's Höver cement plant. Operational in 2025.
- **Commercial Plants:** It is planned for the Demonstration plant to be followed by 200,000 tpa and 800,000 tpa plants in 2026 and 2028 respectively to achieve the full decarbonisation of the Höver site.

**KEY DATA**

TRL	6 - 7	Capture Rate Range (tpd)	10 - 10,000+	Modular (Y/N)	Yes
Source CO <sub>2</sub> Purity Range	>10%	Energy Consumption (GJ/tCO <sub>2</sub> )	Depends on industry	Capture Efficiency (%)	>95%
Number of Commercial Plants	1 underway	Number of Pilot Plants	3		
Target Industries	Cement, Lime, Refining, Steel, Coal-fired Power, Waste to Energy, Paper & Pulp				

# DELTA CLEANTECH CO<sub>2</sub> CAPTURE TECHNOLOGY

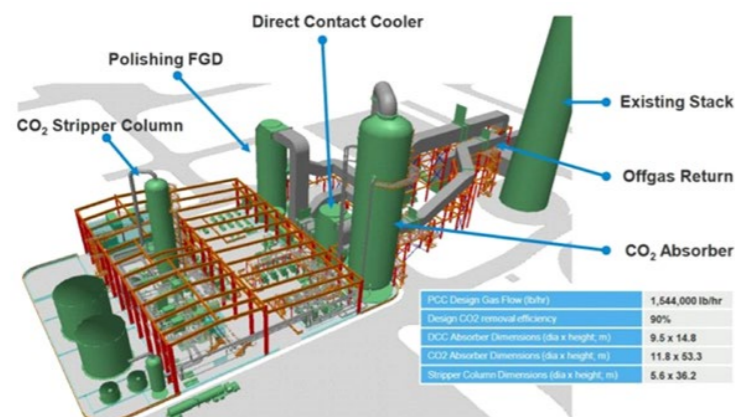

[tbeasley@deltacleantech.com](mailto:tbeasley@deltacleantech.com)

[www.deltacleantech.com](http://www.deltacleantech.com)

## SUMMARY

Since 2004, DELTA CleanTech has been globally recognised as a leading provider of technology for Pre- / Post- Combustion Carbon Capture from industrial sources, enabling significant and economical reduction of greenhouse gas emissions and solvent reclaiming. DELTA's goal is to deliver practical solutions to reduce greenhouse gas emissions and help solve the challenges of energy security. Through its commercial relationships, DELTA implements the Best Commercial Technologies (BCT) in carbon capture and utilisation with leading EPC's and Fabricators around the world.

Delta has developed the proprietary subcomponent technologies of the Delta CleanTech CO<sub>2</sub> Capture Technology including LCDesign, a low-cost design carbon capture system, including recently launched EM3 Technology®, PurificationRX®, a solvent purification and recycling system and OEXperts – a owners engineering company providing CCUS expertise to the plant owner if required. The collective learnings from over 100 current and previous Carbon Capture Projects worldwide give Delta a distinct advantage in Carbon Capture Space. Delta has successfully designed carbon capture plants with a capacity ranging from 1 to 7,000 metric tonne CO<sub>2</sub> per day (TPD).

## BENEFITS

- Simplicity:** LCDesign® process configuration is simplified.
- Scalability:** It can be scale from 1 to 7,000 TPD or more.
- Affordability:** A cost-effective carbon capture system with minimal CAPEX and OPEX.
- Integrability:** It can be fitted with a new or existing Pre-/ Post- Combustion process.
- Suitability:** It can capture CO<sub>2</sub> from any gas stream at wide CO<sub>2</sub> content (from 2.5 to 70 volume %).
- Performability:** Designed to capture CO<sub>2</sub> at any recovery ratio (up to 99%) at the lowest possible energy.
- Solvent Availability:** DeltaSolv® solvents are commercially available with no royalty fees added by Delta CleanTech.
- Team Expertise:** Delta Team are professional trained and skilled carbon capture designers with experience with Construction, Commissioning, Operation and Troubleshooting.

## KEY PROJECTS REFERENCES

- Over 10 projects successfully commissioned over the past 10 years.
- Canada's latest CO<sub>2</sub> capture plant for a major oil and gas company currently being commissioned in Canada
- Small and large scale front end engineering and design studies (FEED) studies from 1 TPD to 7,000 TPD on plants including Refineries, Coal Plants, Bio Plants, Steel, Cement NG boilers, Reciprocating engines and others.

## KEY DATA

TRL	9	Capture Rate Range (tpd)	7,000	Modular (Y/N)	Yes
Source CO <sub>2</sub> Purity Range	2.5 - 70%	Energy Consumption (GJ/tCO <sub>2</sub> )	1 - 3.5	Capture Efficiency (%)	Up to 99%
Number of Commercial Plants	6	Number of Pilot Plants	1	Solvent Purification Expertise	Yes
Target Industries	All industrial sources with proper pre-treatment if applicable				

# Equatic EQUATIC

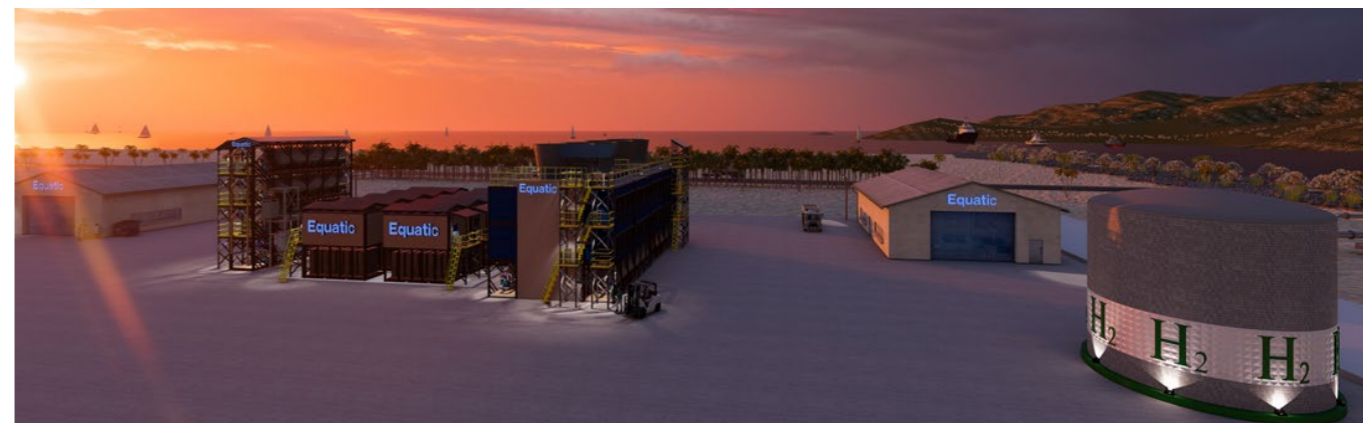

[contact@equatic.tech](mailto:contact@equatic.tech)

[www.equatic.tech](http://www.equatic.tech)

## SUMMARY

Equatic removes carbon dioxide from the atmosphere or from a point source. The process for doing this involves (1) seawater electrolysis with proprietary, oxygen-selective anodes, and (2) direct air contact to immobilise the CO<sub>2</sub> as (bi) carbonates. Green hydrogen is produced at a ratio of 30kg of H<sub>2</sub> for every 1 tonne of CDR. The immobilised carbon is stored permanently in the ocean for between 10,000 and 1 billion years.

## BENEFITS

- Low net energy intensity:** Equatic produces green hydrogen as part of the process, thereby lowering the net energy intensity to ~1.2 MWh/t CDR.
- No storage or transportation costs:** Equatic stores immobilised carbon in the ocean, avoiding the costs and risks of CO<sub>2</sub> storage post-capture.
- ISBL MRV:** Equatic measures the extent of the carbon drawdown within the boundaries of the plant and this forms the basis of the issuance of high-quality, verifiable CDR credits.
- Flexible siting:** Equatic requires renewable energy, seawater, rock and air. The electrolyzers operate at ambient temperature and pressure, enabling use of intermittent renewables.

## KEY PROJECTS

- Equatic-1:** World's largest ocean-based CDR plant under construction in Singapore in 2024. This plant has the capacity to generate 3,650 tpa CDR credits and 110 tpa green hydrogen.
- Commercial Plant:** Currently in engineering stage, this 100,000tpa CDR plant will use the same, modular approach as Equatic-1 with multiple electrolyzers that each remove 1tpd of CO<sub>2</sub> and store it permanently as carbonates and bicarbonates. Operational by 2026 - 2027.

## KEY DATA

TRL	7	Capture Rate Range (tpd)	Each 100kW electrolyzer is 1TPD	Modular (Y/N)	Yes
Source CO <sub>2</sub> Purity Range	>=0.04%	Energy Consumption (GJ/tCO <sub>2</sub> )	4.3	Capture Efficiency (%)	>99%
Number of Commercial Plants	~	Number of Pilot Plants	2		
Target Industries	Carbon dioxide removal, non-geologic CCS (gray to blue hydrogen or ammonia, steel, cement), green hydrogen				



KBR

## KCAP<sup>SM</sup> CAPTURE TECHNOLOGY



[technology@kbr.com](mailto:technology@kbr.com)

[www.kbr.com](http://www.kbr.com)

### SUMMARY

Industrial decarbonisation remains one of the largest challenges of the energy transition. Staying true to its commitment to sustainability and decarbonisation, KBR launched KCAP<sup>SM</sup>, a next generation decarbonisation solution, which will be significant in deploying industrial carbon capture to achieve net zero 2050 goals. KCAP is KBR's advanced decarbonisation solution utilising Hindustan Petroleum Corporation's (HPCL's) patented rotating packed bed (RPB).

KBR has developed the latest carbon capture technology, KCAP, which offers an advanced alternative to conventional post-combustion CO<sub>2</sub> capture by utilising the Rotating Packed Bed (RPB) technology, which was first developed by NASA in the 1970s to overcome the limitations of gravity on vapour liquid systems. KCAP technology is based on process intensification of post-combustion CO<sub>2</sub> capture by replacing the absorption column in a conventional capture process with a rotating packed bed that has a substantially smaller footprint and reduced capex.

### BENEFITS

- **Techno Economic Analysis:** KCAP results in reduced overall capex, reduced equipment sizes and overall plant footprint providing a favorable techno economic analysis of the plant.
- **Scalability:** The compact design of the RPB means facilities can be scaled up while having a reduced overall plant footprint compared to the conventional column system resulting in plot space reduction with 10 times smaller equipment size.
- **Modularisation:** The reduced size of the RPB unit enables standardisation, repeatable design and modularization, resulting in a shorter overall project schedule compared to a stick built conventional carbon capture unit. Modularisation enables minimum site infrastructure requirements, ease of installation and integration with existing assets resulting in an overall cost-effective module.
- **KBR Solutions:** Compression, transfer, storage and utilisation options can be provided along with blue hydrogen and blue ammonia.

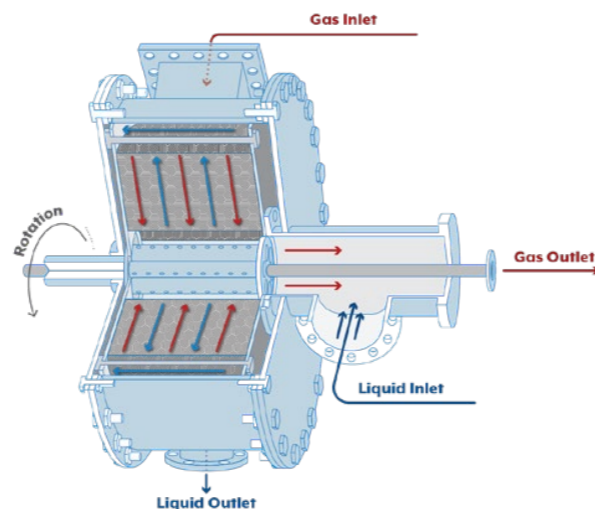

Rotating packed bed comes with high surface area packings. The solvent flows from the center of this surface area packing to the outer shell, due to centrifugal forces. Gas flows from outer periphery to the center, contacting the solvent in a counter current mode. The higher mass transfer rates, smaller equipment, lead to lower capex and hence a cost-effective CO<sub>2</sub> capture solution to deploy in the market.

### KEY DATA

TRL	9	Capture Rate Range (tpd)	50 - 500	Modular (Y/N)	Yes
Source CO <sub>2</sub> Purity Range	2.5 - 22%	Energy Consumption (GJ/tCO <sub>2</sub> )	2.5	Capture Efficiency (%)	92-95%
Number of Commercial Plants	1	Number of Pilot Plants	1		
Target Industries	Gas Plants/LNG Plants, Refineries and Petrochemicals. Hard-to-abate industries including cement				



Value Maritime

VALUE MARITIME

## FILTREE - AN EGCS & CARBON CAPTURE UNIT FOR SHIPS

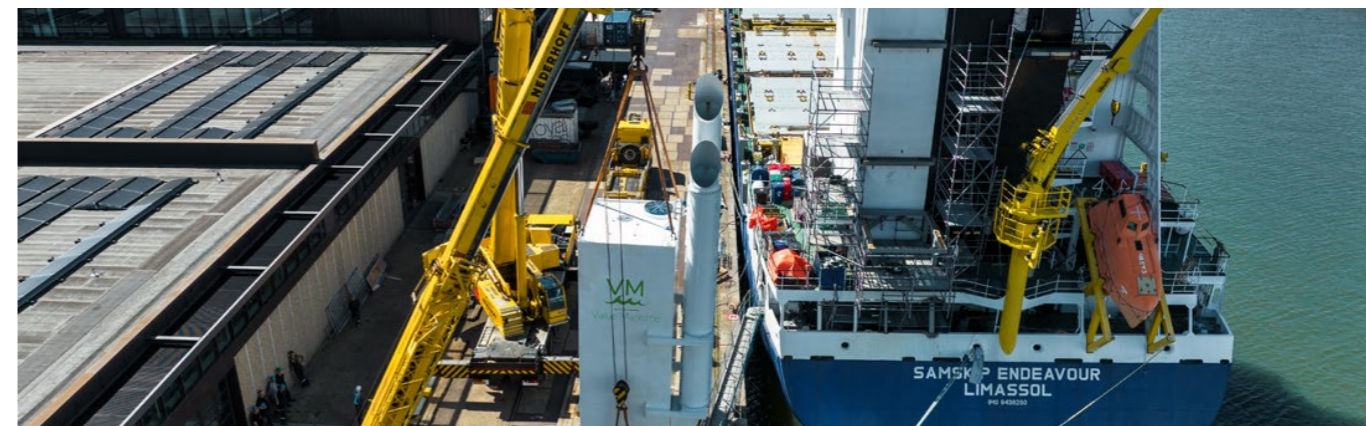

[info@valuemaritime.com](mailto:info@valuemaritime.com)

[www.valuemaritime.com](http://www.valuemaritime.com)

### SUMMARY

The Value Maritime next generation "plug and play" Exhaust Gas Cleaning System (EGCS) Filtree, is quick to install and easy to use. It filters sulphur as well as 99% of ultra-fine particulate matter from the exhausts of small-large size ships while ensuring the wash water used is also filtered and the pH neutralised before discharge. In addition, the Filtree system can also capture CO<sub>2</sub> on board - removing CO<sub>2</sub> from vessels in an easy, energy-efficient and cost-effective manner. The CO<sub>2</sub> capture feature removes and stores carbon from the vessel's exhaust gases in removable storage containers or fixed onboard storage such as tanks. The CO<sub>2</sub> can be used to enhance crop growth, enrich future fuels such as methanol for dual-fuelled vessels or stored underground.

Value Maritime stays ahead and outperforms regulations to offer clients the latest in emission reducing quality technology. The Filtree can go up to engine sizes of 15 MW covering 75% of the total market and multiple ship types. The Filtree system has benefitted over 50 shipping vessels to date. Value Maritime is currently expanding its CO<sub>2</sub> services within Europe, Asia and North America. We are growing the network organically by creating vessel or fleet-specific solutions for customers. We are in the process of arranging CO<sub>2</sub> outlets for customers worldwide along with our sister company Value Carbon and shareholders in Shell Ventures.

### BENEFITS

- **Easy to install, plug & play, with limited downtime.**
- **Green & Financial Dividend.** A Filtree increases the competitiveness of a vessel with lower OPEX and a lower environmental footprint.
- **Efficient.** The integrated CO<sub>2</sub> module can capture up to 80+% of the CO<sub>2</sub> in the vessel's exhaust. By adding or removing CO<sub>2</sub> tanks from vessels, shipowners can up and downscale their total CO<sub>2</sub> storage capacity. As a result with Value Maritime's CO<sub>2</sub> solution, vessels can operate under the most optimal circumstances at all times.
- **Future Proof.** With the option to capture carbon onboard, ships are set up to collect and offload CO<sub>2</sub> with the carbon being handled by Value Carbon.

### KEY PROJECTS

- Proven technology
- 49 Units in operations - Installed onboard container, tanker, multipurpose and dry bulk vessels
  - 12 Filtree
  - 26 Filtree and Carbon Capture - current system captures up to 40% for fuels with sulphur content and 80%+ for zero sulphur fuels.
  - 11 Carbon Capture ready

### KEY DATA

TRL	8	Capture Rate Range (tpd)	~	Modular (Y/N)	Yes
Source CO <sub>2</sub> Concentration	According to required specifications	Energy Consumption (GJ/tCO <sub>2</sub> ) <sup>1</sup>	0.04 MWhe ton CO <sub>2</sub>	Capture Efficiency (%)	<10 - 80%+
Number of Commercial Plants	49	Number of Pilot Plants	0		
Target Industries	Shipping/Maritime/Offshore				

<sup>1</sup> Absorption process only



# TRANSPORT



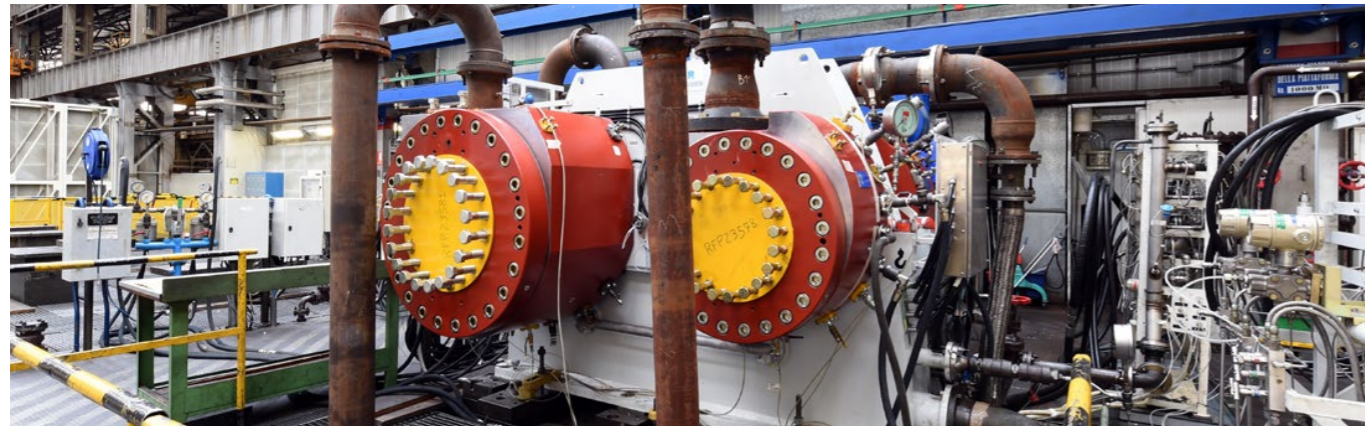

 [gianluca.difederico@bakerhughes.com](mailto:gianluca.difederico@bakerhughes.com)

 [www.bakerhughes.com](http://www.bakerhughes.com)

### SUMMARY

Leveraging its extensive domain expertise in compression and pumping technologies from decades of experience in related areas such as urea, liquefied natural gas and enhanced oil recovery, Baker Hughes has the needed capabilities to make the compression of CO<sub>2</sub> safer, easier and more cost-effective for CCUS applications. Baker Hughes has focused its attention on customising complete compression trains suited for the unique characteristics of CO<sub>2</sub> so that these can operate more efficiently and minimise the overall parasitic power consumption of CCUS processes.

Baker Hughes offers a range of products, including reciprocating, in-line and integrally geared centrifugal compressors, as well as centrifugal CO<sub>2</sub> pumps. These technologies have undergone years of proven in-field performance. Baker Hughes has also continued to develop and optimise these technologies at our global research centers, performing extensive testing in both laboratory and in-field environments before launching these products for our customers' use. In addition to core rotating equipment, Baker Hughes has capability and expertise to provide complete plant solutions that can include CO<sub>2</sub> compression, treatment, liquefaction, and heat recovery.

### BENEFITS

- Reduced compression train parasitic power consumption
- Optimised high compression ratio across a wide range of flow rates
- High reliability and easy maintenance
- Automatic capacity control and safety system to reliably match any operating condition
- Reduced lead time through standardised and containerised production, design thinking for simplified logistics, and decreased demand for civil works
- Comprehensive turbomachinery portfolio to transport CO<sub>2</sub> across the CCUS value chain

### KEY DATA

TRL	9
-----	---

### TECHNOLOGY DESCRIPTION

The operating envelope of CO<sub>2</sub> as it is transported from capture up to utilisation and storage is very broad in terms of volumetric flow and delivery pressure. It ranges from several thousand m<sup>3</sup>/h at relatively low pressures, up to a few hundred m<sup>3</sup>/h at extremely high pressures (700-800 bar). Different technologies are required to manage such wide variations and Baker Hughes has a comprehensive portfolio that can match specific applications. The table below shows which type of technology can be employed in increasing the pressure of a certain CO<sub>2</sub> stream.

Pressure	Configuration
< 200 bar	Inline compressor, integrally geared compressor, centrifugal pump
> 200 bar	Inline compressor, centrifugal pump

By manufacturing both CO<sub>2</sub> compressors and pumps, Baker Hughes is able to identify the optimum configuration between technologies, eventually fine tuning the interstage pressures and review the overall operability and control scheme with the goal of minimising the total power consumption at different operating scenarios.

### INTEGRALLY GEARED COMPRESSORS

Integrally geared centrifugal compressors can deliver a pressure ratio up to 200, with multiple intercooling steps between stages, which is a typical requirement for CO<sub>2</sub> compressors. Baker Hughes' design features a bull gear and from one to four high-speed pinions, with one or two impellers mounted on each pinion shaft. Stand-alone stages optimise impeller speed and allow impellers to operate at higher peripheral speed and optimum flow coefficient. Variable inlet guide vanes are used for part load operation. The net result is a highly efficient, compact compressor solution.

### IN-LINE CENTRIFUGAL COMPRESSORS

Baker Hughes has a strong operating track record in supplying inline centrifugal compressors also for the toughest applications. Inline compressors are high efficiency machines with superior reliability and can be applied across the whole CCUS value chain, completing the portfolio in applications where integrally geared compressors are less present such as ultra-high pressure or extremely toxic gases. BH has experience in compressing and injecting CO<sub>2</sub> for enhanced oil recovery at pressures as high as 550 bar. Multiple train configuration with one, two or even casings in the same shaft line and different drivers such as electric motor, steam turbine or even hot gas expander.

### PUMPS

Baker Hughes' development of its high-pressure CO<sub>2</sub> injection pumps rely on the experience of delivering over 1,000 multi-stage centrifugal pumps for liquefied gas applications. Our multi-stage barrel pump is a good fit for CO<sub>2</sub> applications, especially in supercritical and high pressure services for which, since 2009, Baker Hughes designed the pioneering BB5 pump for EOR service with a design pressure of 670 barg.

In terms of cost expended per unit of mass of re-injected CO<sub>2</sub>, the use of centrifugal pumps in the overall compression process, combined with various forms of heat recovery, is the most favourable solution for CCUS applications and is now a proven technology ready for a various types of injection wells.

### PLANT DESIGN CAPABILITY

Baker Hughes has experience in delivering complex projects, from modular solutions to entire process plants. CO<sub>2</sub> transportation can involve different processes such as dehydration, treatment, liquefaction and heat recovery, and in all of them turbomachinery represents a critical equipment. By designing and providing the complete plant, Baker Hughes can evaluate opportunities for improving system performance, as well as maximising mechanical integration at factory thus minimising footprint and field activities and at the same time mitigating delivery risks by having a single supplier that covers the complete scope.



 [gianluca.difederico@bakerhughes.com](mailto:gianluca.difederico@bakerhughes.com)

 [www.bakerhughes.com](http://www.bakerhughes.com)

## SUMMARY

Baker Hughes can deliver technological pumping solutions that accomplish the end users' stringent requirements and best fit variable operating conditions which characterise the entire CCUS Industry.

Baker Hughes pump technologies cover services that operate with CO<sub>2</sub> as the process fluid across multiple inlet conditions and discharge pressures ranging from 15 to 50 MPa and above, depending on specific applications. Such applications range from transportation to storage and injection of CO<sub>2</sub> or even power cycles (e.g. supercritical CO<sub>2</sub> power cycles) that use carbon dioxide as process fluid. Moreover, high flow circulation pumps cover CO<sub>2</sub> removal services through appropriate organic or inorganic water solutions.

Driven by API610/ISO13709 criteria, Baker Hughes' specific pump design and selection can provide the correct response to the mentioned needs, taking into account specific features that differentiate the CO<sub>2</sub> service from other services.

## BENEFITS

- Accuracy of rotordynamic analysis (leveraging Baker Hughes know-how on API 617 compressors) for high rotor stability
- Impellers arrangement to accommodate the CO<sub>2</sub> high compressibility
- Proper Equations of state selection based on different CO<sub>2</sub> mixtures for accurate pump selection and performances assessment
- Check of acoustic resonance in hydraulic channels through accurate thermodynamic properties
- Optimised seals technology selection (wet and dry gas)
- Validated Water vs. CO<sub>2</sub> correlation laws

## KEY DATA

TRL

9

## TECHNOLOGY DESCRIPTION

The selection of pumps for CO<sub>2</sub> applications needs to take care of several differences between conventional incompressible fluids and supercritical CO<sub>2</sub>. Supercritical CO<sub>2</sub> is a compressible fluid characterised by high density and low viscosity. Traditionally, supercritical CO<sub>2</sub> has been used for crude oil recovery due to its high diffusivity and liquid solubility, while also being soluble in crude oil increasing the mixture's fluidity.

Pump selection must consider the high compressibility of supercritical CO<sub>2</sub> and use a suitable thermodynamic model to predict the behavior of different CO<sub>2</sub> mixtures. An iterative calculation is used to calculate the polytropic head and efficiency with validated correlations between CO<sub>2</sub> and water, reaching convergence at the pump discharge temperature when the polytropic head is equal to the pump differential head. The right pump, acting as a "quasi-compressor" is then selected. The equations of state available to calculate CO<sub>2</sub> mixtures physical properties are different and applied based on pressure, temperature, and chemical components.

Baker Hughes has developed experimental correction factors based on extensive test campaigns where characteristics such as density, specific heat, and speed of sound were measured for various CO<sub>2</sub> mixtures with up to 23 mol% of hydrocarbons and/or inert gases. A reliable pump selection tool that uses Equations of State has been extensively validated over multiple test campaigns in the last ten years. This enables the selection of optimal stand-alone or pre-defined integrated solutions, maximising energy savings (up to 10-15% in supercritical condition and up to 30% in subcooled condition) and minimising the pump's operational carbon footprint.

Additional consideration must be given with respect to the low viscosity of supercritical CO<sub>2</sub>. This has a big impact on pump rotor-dynamics due to the low damping effect provided by the fluid across annular seals. Clearances thus must be carefully calculated, while wear rings need to be made from non-conventional materials. Additionally, the maximum number of stages pump stages can be limited by rotor stability.

Supercritical CO<sub>2</sub> characteristics also influence mechanical seal technology and selection. Based on fluid thermodynamic properties and seal chamber pressure, two different technologies can be applied to CO<sub>2</sub> pumps. These are:

- Engineered double or triple mechanical wet seals (API 682 compliant)
- Dry gas seals (API 692 compliant)

While double or triple mechanical wet seals with pressurised barrier fluid tend to be more reliable, they typically have a larger footprint and consume more power consumption. Dry gas seals, on the other hand, are a well proven technology and Baker Hughes can leverage the extensive experience acquired in these seals from centrifugal compressor applications. Dry gas seals require a smaller space for installation while also absorbing less power, but these need to be installed with a reliable control panel equipped with heater and gas booster to avoid CO<sub>2</sub> freezing during transient operating conditions.



[gianluca.difederico@bakerhughes.com](mailto:gianluca.difederico@bakerhughes.com)

[www.bakerhughes.com](http://www.bakerhughes.com)

**SUMMARY**

Subsea CCS projects require pipelines for transportation of CO<sub>2</sub> to the reservoir. Key requirements of these pipelines include technical capability, cost-effectiveness and risk reduction. Baker Hughes unbonded flexible pipes have a proven track record in CO<sub>2</sub>-rich applications that address these technical requirements. Baker Hughes’ flexible pipe product has the potential to offer significant cost and risk benefits to a CCS project compared to alternative options such as rigid pipes.

**BENEFITS**

- Proven capability for high-pressure CO<sub>2</sub> transportation using standard materials and product design
- Project schedule is hugely benefited when compared to rigid alternatives
- Enabling technology for shallow-water dynamic CO<sub>2</sub> risers

**KEY DATA**

TRL	9
-----	---

**TECHNOLOGY DESCRIPTION**

Baker Hughes has been supplying unbonded flexible pipe to the offshore oil & gas industry for more than 30 years, supporting the development of such projects that face some of the harshest conditions in the world. An unbonded flexible pipe is made up of a series of polymer and metallic layers that are uniquely configured to suit each project’s specific requirements.

The traditional oil & gas industry is witnessing a remarkable surge in demand for CO<sub>2</sub>-compatible pipelines, primarily fueled by the unique challenges posed by CO<sub>2</sub>-rich pre-salt reservoirs in Brazil. In these projects, CO<sub>2</sub> stripped from the pre-salt fields’ production fluids is reinjected into the reservoirs at high pressures.

Baker Hughes has undertaken significant research and development over more than five years to support the use of its conventional flexible pipe products in CO<sub>2</sub>-rich applications. This research, which includes small-, mid- and full-scale tests, has led to a detailed understanding of the critical design parameters for transporting CO<sub>2</sub>. A review by an Independent Verifying Authority has led to an approved ‘safe envelope’ of operating conditions under which no failure modes, including stress corrosion cracking, will occur.

Baker Hughes’ proven expertise in CO<sub>2</sub>-rich applications has positioned the company as a leading supplier of flexible pipes, with more than 70 km of such pipes already installed. These CO<sub>2</sub>-compatible products leverage the same set of standard materials and manufacturing techniques employed in more traditional applications, ensuring consistent quality and performance across the board.

Based on the product’s capability and track record, Baker Hughes’ flexible pipes are equally suitable for use in CCS applications and there are clear value propositions for this product. For example, shallow water CCS dynamic applications necessitate a technology that can withstand CO<sub>2</sub> and a high-fatigue environment. Only an unbonded flexible pipe has a proven track record in both.

When used as infield flowlines, flexible pipes can lead to a lower total-installed cost than rigid pipes. Furthermore, flexibles remove the need for rigid jumpers, which require metrology and fabrication before installation. This hugely benefits the schedule at the most critical time – shortly before start-up.

Baker Hughes remains committed to providing cutting-edge, reliable solutions for the offshore oil & gas industry, while simultaneously addressing the growing need for CO<sub>2</sub>-compatible pipelines in CCS applications. By consistently delivering high-quality, innovative products, Baker Hughes cements its position as a trusted partner, helping to shape a sustainable future for the energy sector.



DRIL-QUIP, INC

# CARBON INJECTION AND MONITORING WELLHEADS



[adam\\_forness@dril-quip.com](mailto:adam_forness@dril-quip.com)

[www.dril-quip.com](http://www.dril-quip.com)

## SUMMARY

An essential component of CCS is injecting and permanently storing CO<sub>2</sub> into underground reservoirs. Dril-Quip specialises in equipment that facilitates the well construction, injection, and post-injection monitoring of CO<sub>2</sub>. This equipment is colloquially known as a wellhead. Whether your injection location is onshore, offshore, or subsea, Dril-Quip provides wellhead products specifically designed for the unique requirements of CCS.

Dril-Quip's CCS wellheads are tailor-made for CCS applications by addressing the unique risks of CO<sub>2</sub> injection that are not always present in traditional wellhead use cases. Two particular risks are the corrosiveness of CO<sub>2</sub> when water is introduced, and the cryogenic effects when a pressure drop in CO<sub>2</sub> occurs across an orifice. Dril-Quip is conducting materials testing through third-party laboratories and seal testing in-house, specific to CO<sub>2</sub> injection requirements to ensure our products are suitable for these scenarios.

## BENEFITS

- Track record from early mover projects
- Bespoke products designed specifically for CCS
- Engineered to tolerate low purity CO<sub>2</sub> and Carbonic Acid
- Low-Temperature Seals and Materials Compatible with Joule-Thomson cooling effects
- Equipment provisions for CO<sub>2</sub> monitoring and pressure management, including fiber optics behind the injection casing.
- Up to 7-1/16" valves for faster injection rates.

## KEY PROJECTS

- **Greensands:** First injection in March 2023 via Offshore Platform Wellhead
- **Alberta Carbon Grid:** Equipment for Three CCUS appraisal wells, 2023
- **Heartland Carbon Project:** Four Wellheads ordered, 2023
- **Subsea CCS Exploration Well:** One Wellhead ordered in 2024
- **Enbridge:** 15+ years providing engineered wellhead systems included +200 cavern and monitoring wells

## KEY DATA

TRL	7 to 9	Temperature rating	-75°F to 250°F (-60°C to 121°C)
Source CO <sub>2</sub> Purity Range	No Limit	Injection Pressure Rating	Up to 15 ksi (104 MPa)

## TECHNOLOGY DESCRIPTION

Dril-Quip has three types of injection wellheads, each unique to the injection location: onshore, offshore-from-a-platform, and subsea. Each product's design has been re-engineered for CO<sub>2</sub> injection purposes.

### ONSHORE

Dril-Quip has recently acquired Great North, an onshore wellhead company based in Alberta, Canada, with an extensive track record in gas storage and CO<sub>2</sub> injection for EOR (enhanced oil recovery) purposes. This experience lends itself to supporting your CO<sub>2</sub> injection projects including permitting applications. Onshore wellhead products can easily facilitate the installation of fibre optic cables behind the casing string to support monitoring, measurement, and verification (MMV) plans.

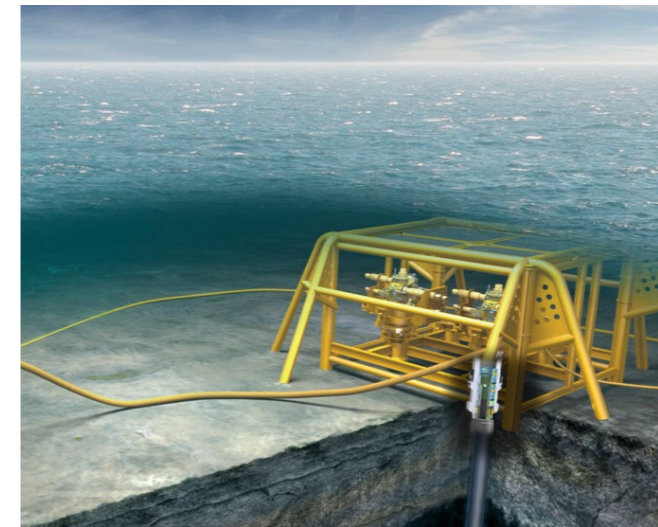

### OFFSHORE

Dril-Quip has a long history of serving the offshore industry. Offshore storage wells have the unique advantage of being located away from communities and in remote locations. Dril-Quip's offshore wellhead products can be subdivided into two categories: Platform Wellheads and Subsea Wellheads.

#### Platform Wellheads

Dril-Quip's Platform Wellheads reside on semi-permanent platform structures, providing offshore access to CO<sub>2</sub> storage reservoirs beneath the seabed. Because these wellheads remain above the ocean surface, they provide similar MMV advantages to onshore wellheads, but can be located in remote offshore locations. These wellheads operate safely and efficiently within the unique constraints of an offshore environment.



### Subsea Wellheads

When water depths are too deep for offshore platforms to be economically constructed or when injection wells are to be spread far apart, Dril-Quip's Subsea Wellheads are used to facilitate access and pressure control of subsea storage sites. Due to its ease of use and minimised carbon footprint, Dril-Quip's Subsea Wellhead product line is the industry's preferred solution for subsea projects. Dril-Quip has invested heavily in product engineering and design to make its subsea products the most economical and environmentally friendly on the planet.



# LCO<sub>2</sub>-EP (ELEVATED PRESSURE) AND OPTIMISATION OF THE CCS VALUE CHAIN



[tin@kn-cc.com](mailto:tin@kn-cc.com)

[www.kn-cc.com](http://www.kn-cc.com)

## SUMMARY

Knutsen NYK Carbon Carriers AS ("KNCC") is a joint venture company between Knutsen of Norway and NYK of Japan. The objective for the company is to offer all LCO<sub>2</sub> transportation modes; low pressure ("LP"), medium pressure ("MP"), and elevated pressure ("EP," working range 0-10°C / 34-45 barG), catering to the CCS market under rapid development. In this compendium, we will focus on the features of LCO<sub>2</sub>-EP and the specially designed containment system, the Cargo Tank Cylinders (CTC). In addition to introducing and marketing EP for marine transportation of LCO<sub>2</sub>, KNCC is actively engaged in the entire CCS value chain to identify cost reductions. In the following, we present two of our studies conducted in collaboration with Chiyoda Corporation ("Chiyoda") on the "Quantitative Comparison of CO<sub>2</sub> Liquefaction, Temporary Storage, and Transportation," as well as with JX Nippon Oil & Gas Exploration Corporation ("JX") on the "Optimisation of CO<sub>2</sub> Liquefaction and Storage Process."

## BENEFITS

- Less energy requirements for liquefaction, and less heat and pressurisation prior to injection into the reservoir, resulting in lower overall OPEX.
- Suitable for the concept of both Terminal To Terminal ("TTT") and Direct Injection Offshore ("DIO"), which eliminates the need for onshore terminal facilities and pipeline to the reservoir.
- Ambient/non-cryogenic requirements, with a working temperature of 0°C, facilitating for the application of lower-grade steel and corresponding low CAPEX.
- LCO<sub>2</sub>-EP utilises the CTC which is planned to be produced through an automated series production by a dedicated factory. This will result in a significant shorter tank manufacturing period, particularly for onshore tanks which will contribute to shorter overall project timelines.
- The EP working pressure, 34-45 barG, allows for greater tolerance towards CO<sub>2</sub> impurities without requiring special design or special operational procedures
- EP, with a lower energy requirements for the liquefaction process, has also the potential to reduce the required land space and tank volume across the value chain.

## KEY PROJECTS

- **Project One:** CO<sub>2</sub> marine transportation. Especially CO<sub>2</sub> direct injection offshore projects in any region (Europe and Asia Pacific).
- **Project Two:** Opportunities for reservoir and well testing of amongst others injectivity
- **Project Three:** Projects fit the aim of the study with JX. It is to enable onshore carbon capture projects that intend to load the LCO<sub>2</sub> to a vessel with minimised CAPEX/OPEX and minimised required land space.

## KEY DATA

TRL	6	Number of Pilot Plants	1	Modular (Y/N)	Yes
Target Industries	Marine transportation, onshore tank if EP apply to the CCS value chain				

## TECHNOLOGY DESCRIPTION

Figure 1 illustrates the CCS value chain with the three CO<sub>2</sub> transportation modes: LP, MP, and EP, represented by their respective temperature and pressure. CO<sub>2</sub> transport, with the objective of injection into CCS wells, typically requires pressure ranging from 50 bar to 300 barG, although specific requirements may vary from project to project.

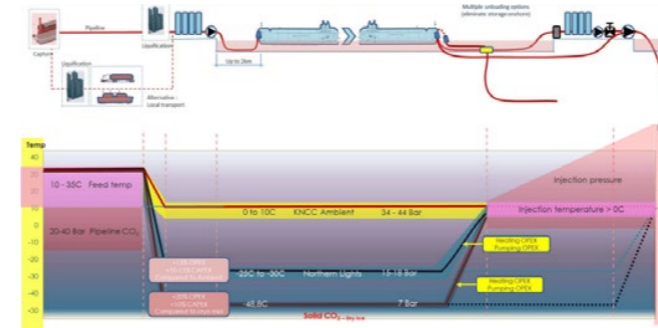

Figure 1: Energy conditions of LP/MP/EP through CCS value Chain

CO<sub>2</sub> needs to be pre-conditioned above 0°C before injection into CCS wells regardless of LP/MP/EP. EP is unique to CO<sub>2</sub> in the CCS industry and contributes to the concept of lower OPEX and CAPEX. Additionally, in the case of DIO, this feature reduces the need for additional equipment, providing advantages in terms of space availability and CAPEX/OPEX reduction. EP further optimises for the DIO concept, due to the elimination of the requirement for onshore terminal facilities. To realise this concept, the CTC has been developed as a storage tank in accordance with the IGC code and CNG principles. Carbon steel is used considering the working temperature of 0°C, in order to minimise the steel costs, also taking into account that the total weight of steel is higher compared to other modes.

The CTC will be fabricated using an automated series production approach. This method reduces the need for manual labour, leading to shorter lead times and requiring fewer workers. This is particularly advantageous for the CCS market, which often involves large-scale infrastructure and significant workloads.

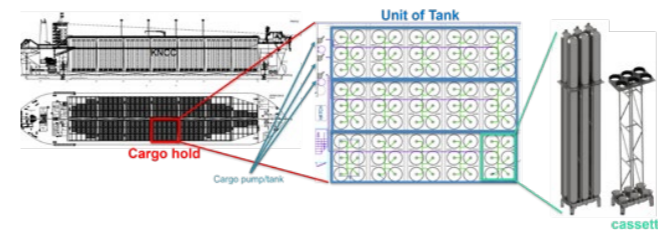

Figure 2: CTC arrangement sample for a LCO<sub>2</sub>-EP

## CO<sub>2</sub> IMPURITY

The CCS industry considers CO<sub>2</sub> impurities to be a significant issue. The type and variety of CO<sub>2</sub> impurities can vary depending on the emitter plant, and even impurities in the ppm range can cause changes in the CO<sub>2</sub> phase diagram. The main reason for liquid phase transportation of CO<sub>2</sub> is to achieve volume efficiency, allowing for 500 – 800 times higher volume compared with CO<sub>2</sub> in gas phase.

Figure 3 illustrates a sample phase diagram change in terms of pressure-enthalpy. The left side represents the case of pure CO<sub>2</sub>, while the right side represents a case

with 99.0% CO<sub>2</sub>, 0.5% H<sub>2</sub>, and 0.5% N<sub>2</sub>. In this particular case, liquid transportation requires a minimum pressure of 30 bar G; otherwise, transportation would be conducted in the gas phase. The CO<sub>2</sub> impurities has implications throughout the entire cargo handling process, requiring careful consideration of mechanical, operational, health, safety, and environmental (HSE), as well as reservoir storage aspects.

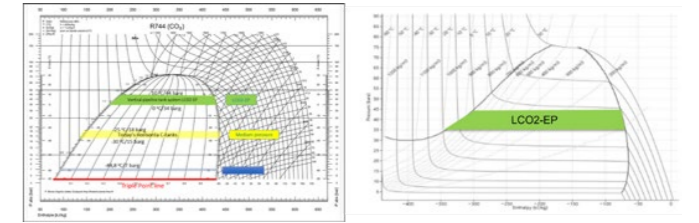

Figure 3: Phase diagram (pure CO<sub>2</sub>, 99%CO<sub>2</sub>/0.5%H<sub>2</sub>/0.5%N<sub>2</sub>)

## CCS VALUE CHAIN APPROACH

The CCS industry is still in its early stages, and there are a huge potential for further optimisation. Collaboration with experts from different fields is the key to push CCS optimisation and simplification aiming for lower costs. Below we present two case studies highlighting the importance of collaboration in achieving CCS materialisation and optimisation.

### 1. Evaluation of the CCS value chain with Chiyoda

The base assumptions are, a CO<sub>2</sub> emitter in Japan handling 2 Mtpa and evaluating terminal to terminal transportation, the following key points were highlighted.

- The comparison between EP, MP, and LP liquefaction and transport in Japan showed that CAPEX is similar for LP and EP, but relatively higher for MP due to the large number of tanks required. In terms of OPEX, EP is lower through liquefaction and injection compared to MP/LP.
- Long haul case, LP had an advantage in terms of marine transport costs. However, EP was confirmed to have an advantage across the entire CCS value chain.
- Challenges: The study identified temporary onshore storage as the most challenging aspect of the value chain due to the prolonged construction period.

Global CCS Institute presentation material on 2024/3/4

[Quantitative Comparison of CCS Value Chain with LCO<sub>2</sub> three modes \(LP/MP/EP\)](#)

### 2. Joint Study on Optimisation of CO<sub>2</sub> Liquefaction and storage Process with JX

This study aims to optimise the CO<sub>2</sub> transportation system by leveraging the unique characteristics of the EP method. The objective is to address challenges in the CCUS value chain, including capital investment, energy consumption, and environmental impact. To verify these aspects, the study will utilise KNCC's CTC demonstration facility test rig located in Haugesund, Norway. Based on the results of this verification, the study will explore the feasibility of implementing these optimisations on a broader scale.

#### Press Release

[JX, NYK, and KNCC Jointly Study Optimisation of CO<sub>2</sub> Liquefaction and Storage Process](#)



# HIGH PRESSURE INTEGRALLY GEARED CENTRIFUGAL COMPRESSOR

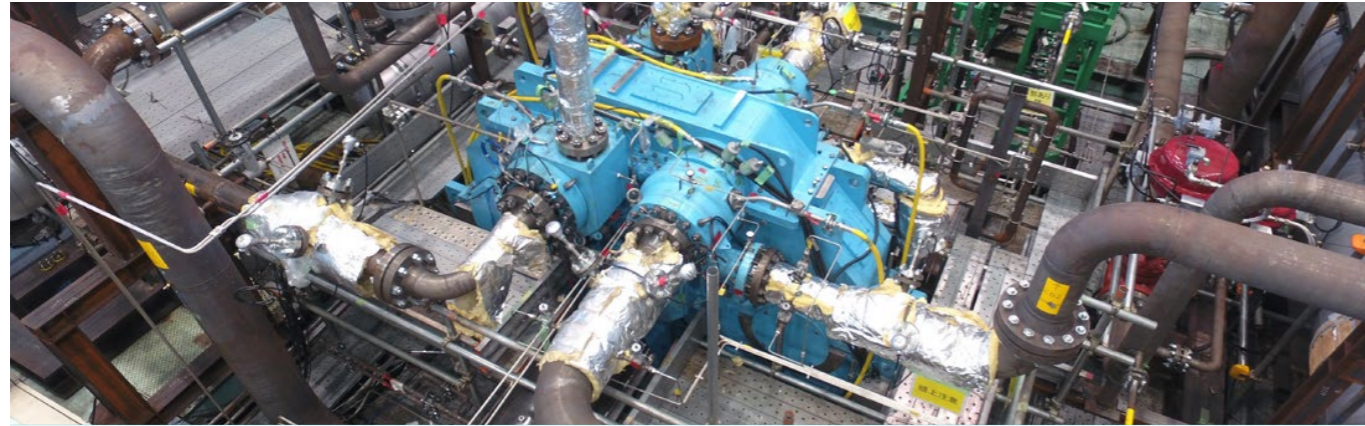

[sales.comp-m@kobelco.com](mailto:sales.comp-m@kobelco.com)

[www.kobelco-machinery-energy.com/en/compressor](http://www.kobelco-machinery-energy.com/en/compressor)

## SUMMARY

Energy savings have become a prevailing trend in industrial machinery as a response to the global warming issue. KOBELCO compressors, utilised in various manufacturing plants and facilities, now face a heightened demand for energy efficiency, particularly in power reduction. The utilisation of high-pressure CO<sub>2</sub> centrifugal compressors in carbon capture and storage (CCS) applications has increased remarkably, facilitated by significant technological advancements. Integrally geared centrifugal compressors, benefiting from optimised rotating speeds for each stage and the ease of intercooler integration, have been adopted as a solution for reducing power consumption. Consequently, the development of high-pressure CO<sub>2</sub> centrifugal compressors aligns with the imperative of energy conservation.

## BENEFITS

High Efficiency & Compact Arrangement:

- Optimised Rotating Speeds: Integrally geared centrifugal compressors enable the customisation of rotating speeds for each stage, thereby achieving high efficiency.
- Cooler Arrangement: The straightforward insertion of intercoolers between stages facilitates the reduction of compression power by lowering suction temperatures at each stage, resulting in decreased power consumption.

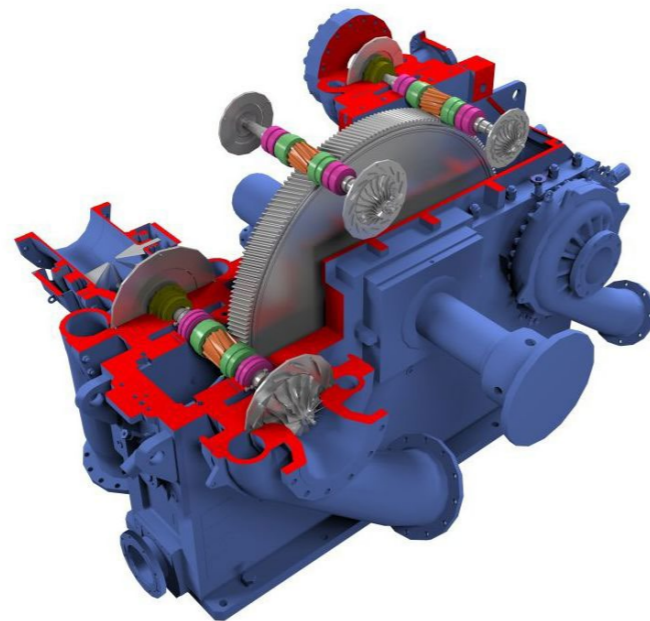

## KEY DATA

TRL	9	Number of Commercial Plants	3	Number of Pilot Plants	1
Target Industries	-				

## TECHNOLOGY DESCRIPTION

KOBELCO is one of the leading steel manufacturers in Japan, as well as a major supplier of aluminium and copper products. Other business segments include machinery, construction machinery, power supply, and others.

In the machinery business, KOBELCO is a unique company capable of supplying all three types of compressors - screw, centrifugal, and reciprocating compressors since 1915. Each type of compressor possesses its own strengths and characteristics, such as capacity, pressure range, and the gases they handle.

Centrifugal compressors are broadly classified into in-line compressors and integrally geared centrifugal compressors. However, integrally geared centrifugal compressors have expanded their fields due to their excellent qualities.

In an integrally geared centrifugal compressor, pinion shafts with different rotational speeds are generally arranged on both sides of a large gear driven by a low-speed driving machine. Since each impeller is mounted on both sides of the pinion shaft, the impeller diameter of each stage and the rotating speed of each shaft can be easily selected according to the specifications. This allows for a high pressure ratio per single stage and a high compression ratio to be realised. Additionally, the application of the open backward type impeller and the optimal selection of the flow coefficient ensure high efficiency and performance. Furthermore, in terms of package arrangement, intercoolers can be easily arranged between each stage to realise a compact package design and a highly efficient compressor, thereby reducing power consumption.

KOBELCO has been manufacturing integrally geared centrifugal compressors for process gas applications, such as air, nitrogen, hydrocarbons, toxic, and flammable gases.

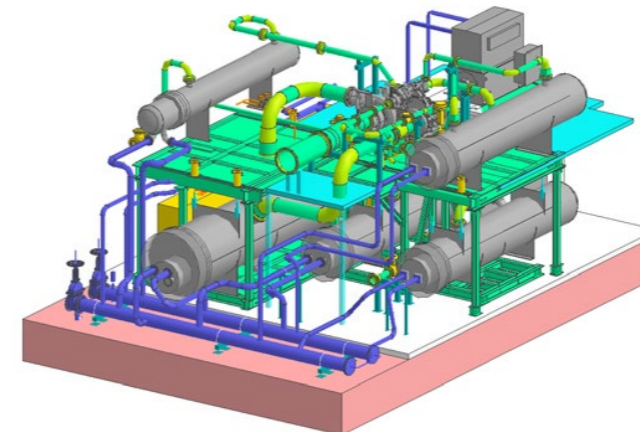

## INTEGRALLY GEARED COMPRESSOR FOR HIGH PRESSURE APPLICATION

To address the global warming problem, energy-saving and decarbonisation have become trends in the industrial machinery industry. Specifically, the response to CCS applications, which are recognized as part of decarbonisation efforts, is required. KOBELCO has developed a compressor with a discharge pressure of 20 MPaG to apply it to high-pressure applications. The key requirements for such a compressor include designing it to withstand high-pressure CO<sub>2</sub>, ensuring rotor stability, and verifying performance. Stress analysis using the finite element method (FEM) was conducted during trial manufacturing to design the compressor casing to withstand high-pressure CO<sub>2</sub> gas. Strain measurements of the casing during the pressure resistance test were carried out to verify the analysis results, confirming the validity of the pressure resistance design.

In a high-pressure compressor, the high density of the fluid causes an exciting force to act on the impeller and the seal, necessitating vibration stability against unstable vibration. Stability evaluation was conducted by exciting the rotor system from the outside using electromagnet technology designed specifically for this purpose. After verifying each element, a demonstration test was conducted with the pressure increased to 20 MPaG. Mechanical stability and performance were verified, confirming successful operation.

KOBELCO's integrally geared centrifugal compressor will contribute to future environmental issues.

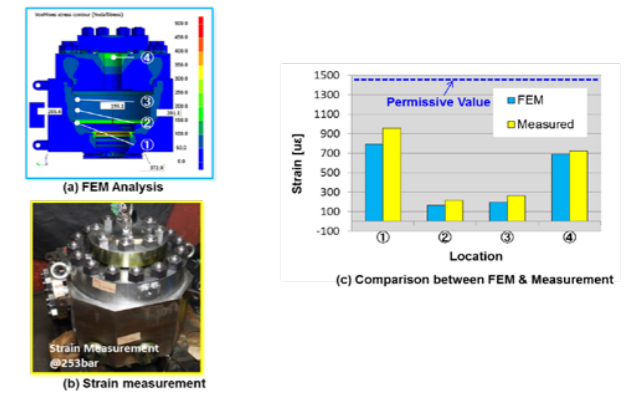

Figure 1: FEM Analysis and Strain Measurement Results of Compressor Casing



MAXTUBE

# DUOLINE 20® FIBERGLASS (GRE) LINED TUBING IN CO<sub>2</sub> INJECTION & SEQUESTRATION



[ccs@maxtube.com](mailto:ccs@maxtube.com)

[www.maxtube.com](http://www.maxtube.com)

## SUMMARY

Maxtube are the proprietors of Duoline Technologies - the pioneers of Fiberglass (GRE) Internal Lining systems used to prevent corrosion in downhole steel tubing. Over 110 million feet of Duoline 20 GRE lined tubing has been run in over 55,000 wells worldwide, including over 30 million feet in CO<sub>2</sub> injection wells.

Duoline 20 is a Glass Reinforced Epoxy (GRE) liner, which is inserted inside carbon steel tubing to protect it from corrosive constituents in the process fluids. Duoline GRE Lined tubing is a proven workhorse in preventing corrosion in extreme environments including high temperatures, high pressures, high concentrations of dissolved gases, high chlorides, and high flow rates as well as mechanical “abuse” during multiple downhole interventions.

Carbon steel tubing, lined with Duoline 20 GRE, is a US EPA approved alternative to CRA downhole tubing in Class VI wells used to inject CO<sub>2</sub> for long term storage.

## BENEFITS

There are two distinct contributions that Duoline 20 GRE lined tubing can make to reducing the carbon footprint of a CCUS project.

Firstly, Duoline 20 GRE lining provides a corrosion barrier which protects carbon steel tubing for decades. The combined system costs a fraction of chrome and higher alloy steel tubing. Additionally, unlike sensitive alloy steels, Duoline GRE liners will offer consistent corrosion protection irrespective of contaminants in the flue gases from different industrial sources over the life of the project.

Secondly, eliminating the use of chemicals for corrosion inhibition means eliminating carbon emissions from chemical manufacture, transportation, and injection into the wells over the life of the well.

These benefits of applying Duoline 20 GRE Lined tubing in CCUS enable significant reductions in Capex and Opex over the lifecycle of the wells thus enhancing the overall viability of the project.

## KEY DATA

TRL	9	Number of Commercial Plants	1 manufacturing and 8 lining sites worldwide	Modular (Y/N)	Portable Lining Units available for onsite lining
Target Industries	Point source injection sites and CCUS hubs				

## TECHNOLOGY DESCRIPTION

The Duoline 20 Lining system consists of a fiberglass reinforced epoxy resin composite liner cemented inside low alloy carbon steel tubing. The cement transfers fluid pressure to the steel. The ends of the liner are protected from mechanical damage by end caps called flares. A polymeric Corrosion Barrier Ring extends the corrosion barrier across the coupling between two adjacent flares.

### DUOLINE 20 GRE LINED TUBING IN CO<sub>2</sub> INJECTION

The earliest known successful application of fibreglass-lined tubing to combat CO<sub>2</sub> corrosion was a CO<sub>2</sub> Injection EOR project in Canada in 1984 in the Joffre Viking Tertiary Oil Unit.

Since then, Duoline 20 has been used extensively by Equinor, ExxonMobil and Oxy in CO<sub>2</sub> injection wells. In the United States, nearly 20 million feet of Duoline GRE Lined tubing has been used in CO<sub>2</sub> injection wells. In 1996, Statoil were among the first to use Duoline GRE Lined Tubing in offshore Water Alternating CO<sub>2</sub> (WAG) wells.

Duoline 20 has since become highly sought after for tubing material in CO<sub>2</sub> injection wells, CO<sub>2</sub> WAG wells, carbonated water injection wells and hydrocarbon producers with high CO<sub>2</sub> concentrations. Duoline GRE has been tested and field-proven to withstand dense phase CO<sub>2</sub> (wet and dry) and low pH solutions from dissolved CO<sub>2</sub>, for decades.

Duoline 20 GRE lined tubing offers attractive savings compared to capital intensive high-chrome materials that are often the metallic selection for CO<sub>2</sub> applications.

CCUS projects depend on dehydration of the CO<sub>2</sub> gas to prevent corrosion. It is challenging to maintain the 100% absence of moisture downhole. The impact of residual water from the reservoir during shut-in of CO<sub>2</sub> injection wells is also a concern. These risks necessitate a pre-emptive corrosion prevention strategy.

Over the life of CCUS projects, it is expected that the injected gas may be contaminated with NO<sub>x</sub>, SO<sub>x</sub> and other contaminants from flue gases generated at various industrial sources. The performance of metals is sensitive to variations in the composition of process fluids. Duoline GRE liners, on the other hand, offer consistent corrosion resistance irrespective of variations in constituents over the life of the project.

The above points demonstrate how Duoline GRE enhances the integrity of CO<sub>2</sub> injection wells. Duoline GRE Lined tubing offers substantial value to the overall viability of CCUS projects. Whether the well is onshore or offshore, platform or subsea, Duoline GRE lining is an optimum solution for tubing corrosion prevention.

## INDUSTRY AND REGULATORY AUTHORITY ENDORSEMENTS

Duoline GRE liners have been tested extensively for resistance to exposure to a variety of industry chemicals, full-scale combined loading inside tubing, pressure cycling, high erosional velocities, fatigue, and durability when exposed to downhole, coiled tubing and wireline, interventions.

Saudi Aramco, Shell, BP, Eni, and Statoil have conducted tests to confirm the viability of Duoline 20 GRE lined tubing as an alternative to chrome alloy steels.

Eni performed qualification tests on Duoline 20 GRE Lined tubing for high-velocity gas production. These include tests to confirm the erosion resistance and mechanical properties of Duoline GRE which proved that its fatigue resistance is about nine times higher than super-duplex stainless steel.

BP performed comprehensive testing to demonstrate the fatigue resistance of the system. Duoline GRE lined assemblies were internally pressurised to 8,000 psi and exposed to one million load cycles. They were also subjected to ISO 13679 loading in the first quadrant. None of the assemblies showed any leaks or signs of damage to the GRE liner and the components in the connection area.

Duoline GRE has been used in wells with temperatures up to 145 °C (293 °F) and has also been tested for resistance to flash freezing to temperatures as low as -69 °C (-92 °F) caused by uncontrolled depressurisation of injected CO<sub>2</sub>. The resistance of Duoline GRE to temperature swings is particularly relevant considering the phase change sensitivity of CO<sub>2</sub> relative to temperature and pressure (Joule Thomson effect).

Operators have tested the compatibility of the Duoline 20 GRE Lining System with several premium connections. These confirm that the Duoline’s GRE lining process and system components do not affect the connection dimensions, torque values and gas sealability. Duoline 20 GRE Lining systems have been applied on premium connection tubing from Tenaris, Vallourec, and JFE, among others.

In the US, experience and good practices recorded in CO<sub>2</sub> injection are documented as regulatory alternatives and operating practices for the geological sequestration of CO<sub>2</sub> by the United States’ Environmental Protection Agency (US EPA). Federal Requirements under the Underground Injection Control (UIC) Program for CO<sub>2</sub> sequestration wells, are codified in the US Code of Federal Regulations, known as the Geologic Sequestration Rule, which establishes a new class of injection well (Class VI) and sets minimum technical criteria and well construction guidelines for these wells for the purpose of protecting underground sources of drinking water (USDWs). This guidance describes the construction requirements for an approved Class VI injection well wherein GRE lined tubing is well accounted for.



# CORROSION RESISTANT ALLOY TUBULARS FOR CCS APPLICATION



✉ [shota.tsukamoto@sumitomocorp.com](mailto:shota.tsukamoto@sumitomocorp.com)

🌐 [www.tubular.nipponsteel.com](http://www.tubular.nipponsteel.com)

## SUMMARY

Carbon Capture and Storage (CCS) is seen as essential to achieving a carbon-neutral society. Nippon Steel has a long history of supplying downhole tubular products for oil and gas production assets in a variety of material grades and connections. As the technology used in the O&G industry can also be applied to CCS, we have an extensive track record of supplying our tubular products not only to O&G projects but also to CCS projects around the world. Specifically for corrosive environments, we have a high level of expertise in high alloy materials with unparalleled corrosion resistance (Corrosion Resistant Alloys - CRAs). This document summarises the corrosion performance of CRAs for CCS environments according to different impurity concentrations in CO<sub>2</sub>. Our extensive range of CRA tubing products, allowing the best choice for both performance and cost benefit, will certainly assist CCS projects in their best practice selection of CO<sub>2</sub> injection tube properties and cost optimisation.

## BENEFITS

- To enable appropriate material selection in the corrosive environment of CCS applications (CO<sub>2</sub> with contaminant gas) from a wide range of CRA tubular products, providing both corrosion resistant performance and cost optimisation.
- To enable bespoke type fit-for-purpose testing to be carried out to demonstrate validity in the use of CRAs when the target condition of the CCS application environment, which may include some variations in impurity contaminants gases (NO<sub>x</sub>, SO<sub>x</sub>, O<sub>2</sub>), would be beyond our validated data set.
- To provide world-class pipe and tube products with reliable quality control through consolidated production facilities from steelmaking to finishing, such as threading.

## KEY PROJECTS

Nippon Steel has been involved in a number of CCS projects to support Material Selection process. Some of these are:

- Large Scale CCS Project (Australia): naturally produced CO<sub>2</sub> from offshore gas reservoirs, is separated at the onshore gas plant and re-injected into a giant sandstone formation 2 km beneath Barrow Island, where it remains permanently trapped.
- Offshore CCS Project (Norway): CO<sub>2</sub> captured onshore, will be transported by newly designed ships, injected and permanently stored 2,600 m below the seabed of the North Sea.

## KEY DATA

TRL	9
-----	---

## TECHNOLOGY DESCRIPTION

The materials used for CO<sub>2</sub> injection are currently assumed to be used in wells of approximately 1000-3000 m depth. In addition to mechanical strength of 80 ksi (560 MPa) or higher Specified Minimum Yield Strength (SMYS) class, corrosion resistant materials are required depending on the severity of the environment. In actual well conditions, formation water flowback should always be considered, then corrosion phenomena, including CO<sub>2</sub> corrosion, become an issue. The corrosion performance of CRAs for CCS environments according to different impurity concentrations in CO<sub>2</sub> is summarised.

### CORROSION IN CO<sub>2</sub> WITH CONTAMINANTS GAS IMPURITIES

CO<sub>2</sub> gas for injection in CCS originates from emissions from various industries and almost always contains impurity gases. For example, when post combustion CO<sub>2</sub> capture with fossil fuels is used, such as coal-fired power plants, emissions of CO<sub>2</sub> include oxygen (O<sub>2</sub>), carbon monoxide (CO), sulphur oxides (SO<sub>x</sub>) and nitrogen oxides (NO<sub>x</sub>). The concentration of various impurity gases is reduced to a certain level during the refining stage, but the concentration of impurities in the injected CO<sub>2</sub> varies depending on the emission source concentration and operating conditions.

#### Effect of contaminated O<sub>2</sub> on corrosion

O<sub>2</sub> is recognised to induce localised corrosion on stainless steels. Although super-martensitic stainless steel; SM13CRS suffered pitting corrosion at 2% O<sub>2</sub> contaminant level in a 5wt% NaCl environment with saturated supercritical CO<sub>2</sub>, super duplex stainless steel; SM25CRW showed no pitting even in an environment containing 4% O<sub>2</sub> (Figure 1). From these results, the use of CRAs with better corrosion resistance than Super13Cr steels can be recommended, in CO<sub>2</sub> injection environments with some oxygen contaminant case.

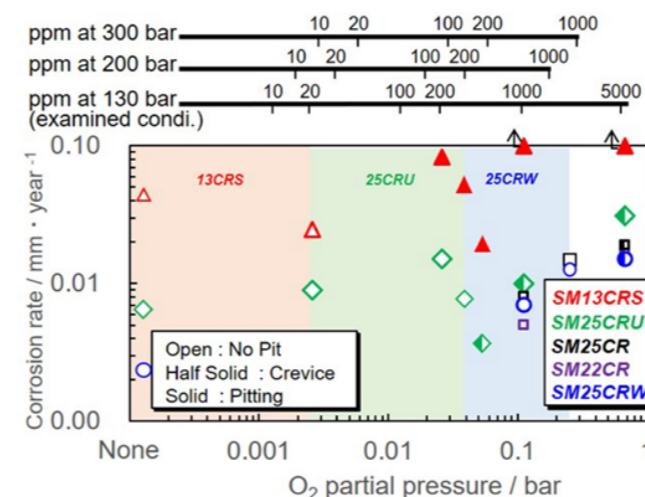

Figure 1 Effect of oxygen content in CO<sub>2</sub> on corrosion of CRAs (100 degC, 5wt%NaCl)

#### Effect of contaminated SO<sub>x</sub> on corrosion

SO<sub>2</sub> dissolves in water to form sulphuric acid, which lowers the pH of the environment. In a pressurised CO<sub>2</sub> environment, contamination as low as 0.02% (200 ppm = 0.0026 MPa at 13 MPa total pressure case) will result in a pH of 2.6. In such an environment, SM13CRS will be severely corroded. At 5,000 ppm, the pH is

approximately 1.9, which is close to the de-passivation pH of 316L and other materials. SM25CRW with PREN ≥ 40 or higher shows excellent corrosion resistance even in such harsh environment, and use of such CRA grades is recommended.

#### Effect of contaminated NO<sub>x</sub> on corrosion

Although NO<sub>2</sub> has a lower solubility to water, when dissolved in water it is thought to form HNO<sub>3</sub> and act to lower the pH of the environment. HNO<sub>3</sub> is a strong oxidising acid and can increase susceptibility to localised corrosion. When coexisting with SO<sub>2</sub>, it has a catalytic effect to oxidise SO<sub>2</sub> and promote the formation of H<sub>2</sub>SO<sub>4</sub>. These strong oxidants promote a number of reactions and are thought to improve tolerance to other impurities by removing as much NO<sub>2</sub> as possible. Further investigation of the effect of NO<sub>x</sub> and SO<sub>x</sub> on corrosion of stainless steels in super critical CO<sub>2</sub> is needed for better understanding for the applicability of materials in CCS application.

#### Effect of other contaminants on corrosion

In environments containing H<sub>2</sub>S, material selection must take into account sulphide stress cracking (SSC) at room temperature and stress corrosion cracking (SCC) at high temperatures, as is well known in oil and gas production environments. In these environments, material selection is required in accordance with the international standard (ANSI NACE MR0175/ISO15156) and also the databases that have been well developed by Nippon Steel. Moreover, the CO<sub>2</sub> injection environment is characterised by a lower pH for the reasons above described, and the challenge for research work to establish the validated data base is needed in consideration for CCS application.

### WAYFORWAD IN OFFERING SUITABLE MATERIAL SELECTION FOR CCS

In CCS projects, optimising the project budget is important and cost-effective material grades are required as much as possible from a CAPEX perspective. It is desirable to use CRA tubes with reliable corrosion resistance for long service life in CCS. The following factors should be considered for material selection;

- Stable passivation even lower than <pH3
- Anti-localised corrosion resistance against oxidising environment which contains O<sub>2</sub> and/or NO<sub>x</sub>
- Anti-environmental cracking resistance against H<sub>2</sub>S

### SUPPLY CHAIN MANAGEMENT

Across all industries - suppliers, operators, and end users are looking for new ways to unlock value and improve sustainability in their supply chains. From process improvement to digitalisation and automation, from new partnerships to carbon reduction initiatives, we, Sumitomo Corporation, reveal strategic options that meet the current needs and anticipate future opportunities. Leveraging our 50+ years history and supply chain management including strategic inventory across the globe, we commit to contribute optimisation of supply operations and just in time delivery for operators' CCS projects.



# COMPOSITE SOLUTIONS FOR CO<sub>2</sub> TRANSPORT



[fgssales@nov.com](mailto:fgssales@nov.com)

[www.nov.com/fgs](http://www.nov.com/fgs)

## SUMMARY

The transition to lower-carbon energy, coupled with the growth in decarbonisation methods, is only possible with a robust transportation network. However, the efficient and safe transportation of large volumes of carbon dioxide from industrial sources to storage or utilisation sites presents several significant challenges. Developing, maintaining, and ensuring the integrity and safety of such infrastructure involves considerable investment, particularly in corrosion control.

As the leading worldwide manufacturer of fiberglass-reinforced epoxy (GRE) products, NOV's Fiber Glass Systems (FGS) business unit provides proven corrosion-resistant composite solutions for onshore and offshore applications in a variety of low- to high-pressure services. In fact, composite pipe from FGS has been used in CO<sub>2</sub> injection lines, high- and low-pressure pipelines, water alternating gas (WAG) systems, and other challenging transportation applications for more than 50 years. FGS brings a comprehensive suite of benefits to CO<sub>2</sub> transport, leveraging the properties of composite technology to enhance reliability and sustainability.

## BENEFITS

- Whether it is 100% wet, dry, or even supercritical CO<sub>2</sub>, our high-pressure fiberglass piping systems eliminate the challenges and concerns of carbonic acid.
- GRE piping systems can be installed as new above- or below-ground pipelines or inserted into an existing pipeline with pull sections up to 1.8 km long.
- In any scenario, our composite solutions bring superior corrosion resistance and ease of installation without the additional cost of coatings, cathodic protection, or expensive alloys.
- GRE has a reduced embodied carbon footprint compared to steel piping systems. On a per kilometer basis, GRE piping systems require 31% less energy to produce and can deliver 65% energy savings throughout a 20-year life cycle due to a smoother inner pipe surface. The lightweight nature of GRE pipes can greatly reduce the emissions caused by travel. Shipping GRE pipe via semi-trucks can reduce CO<sub>2</sub> emissions by up to 77%.

## KEY DATA

TRL	9
-----	---

## TECHNOLOGY DESCRIPTION

FGS specialises in designing and manufacturing high-quality fiberglass pipes and systems renowned for their excellent corrosion resistance, durability, and reliability. We are proud to offer a family of industry-leading line pipe products that combine strength, durability, and corrosion resistance. These products are an ideal choice for the demanding environments inherent in carbon capture and CO<sub>2</sub> transportation systems.

Our Fiberspar™ spoolable line pipe consists of an inner thermoplastic pressure barrier reinforced by high-strength glass fibres embedded in an epoxy matrix. It is intended for corrosive gathering and injection applications, including general and sour-produced fluids and gases. Fiberspar is available with high-density polyethylene or high-temperature polyethylene pressure barriers with temperature ratings of 150°F (65°C), 180°F (82°C), and 203°F (95°C). This high-pressure pipe is available in continuous lengths of up to 9,000 ft (2,743 m) and is immune to corrosion. Our products are designed with service factors for water, oil, and gas in full compliance with API RP 15S, API 15HR, and CSA Z662.



Fiberspar Spoolable Fiberglass Pipe

Our proven family of jointed line pipe, such as Star and Star Super Seal HP, is manufactured in sizes ranging from 1/2-in. to 42-in. (40-mm to 1,050-mm) diameters. Depending on size, these products will handle pressures from 150 psi (1.0 MPa) to 3,500 psi (24.1 Mpa) and temperatures up to 212°F (100°C).

Our high-pressure products are commonly used to transport highly corrosive produced water and CO<sub>2</sub> gas from an oil field's central station to injection wells and have

a proven track record in handling CO<sub>2</sub>. The epoxy resin systems we offer include aliphatic amine, aromatic amine, and anhydride curing agents, each providing slightly different chemical and temperature resistance. Our line pipe is manufactured to a minimum design life of 20 years at rated temperature and pressure in accordance with ASTM D2992 Procedure B and industry standards such as API 15HR and 15LR.

The latest development in our high-pressure, large-diameter product offering is the patented Star Super Seal Key-Lock (SSKL), which achieves the fastest and easiest installation with jointed fiberglass pipe. With sizes spanning 8 in. to 40 in., SSKL can withstand pressures of 300 to 3,000 psi and with temperatures of 150°F (65°C), 200°F (93°C), and 212°F designs available. Our high-pressure designs are laminate designed using API 15HR and ISO 14692 procedures, making them reliable and trusted products in our portfolio.



Star Super Seal Key-Lock

Its unique joining system specialises in the key-lock method of a self-restrained joint, offering quick assembly in minutes by utilising ductile locking keys for mechanical restraint. The joint is directly inserted with no rotation and is available with one or up to 10 locking keys, depending on diameter and pressure requirements. A hydrostatic seal is made by means of an elastomeric O-ring.

Field support during installation is an integral part to ensure the reliability and long-term, worry-free performance of your piping system. FGS offers complete training and inspection services for all products throughout the world.



[dmayer@nebulaenergy.net](mailto:dmayer@nebulaenergy.net)

[www.nebulaenergy.net](http://www.nebulaenergy.net)

**SUMMARY**

Nebula Energy's Orbiter System enables versatile, cost-effective transportation of liquified CO<sub>2</sub> (LCO<sub>2</sub>) for CCS.

The Orbiter System efficiently transports LCO<sub>2</sub> from onshore point-source capture to permanent sequestration sites via ISO containers.

1. An industrial facility with CO<sub>2</sub> recovery operations fills ISOs with captured LCO<sub>2</sub>.
2. The CO<sub>2</sub>-filled ISO is trucked directly to an injection site for onshore CO<sub>2</sub> sequestration, or delivered by truck to a container port, where the ISO is transferred to an Orbiter vessel. From the vessel, the LCO<sub>2</sub> can be directly injected from the ISO into a reservoir or CO<sub>2</sub> carrier.

The Orbiter System accelerates the timeline for initial CO<sub>2</sub> injection, establishing connections between multiple emitters and storage facilities. Its flexibility and scalability allow for seamless transitions from demonstration projects to full-scale commercial operations.

By integrating with local CCS Hubs, the Orbiter System enhances the economic viability of the entire CCS value chain. This integration ensures widespread affordability and scalability, making CCS initiatives more accessible and impactful.

**BENEFITS**

- **Where pipelines are not feasible.** In areas where building pipelines isn't viable economically or politically, Orbiter can be expanded to aggregate LCO<sub>2</sub>. One Orbiter Vessel equipped with 120 ISOs can carry more than 800,000 tons of CO<sub>2</sub> annually. This capacity can be increased by scheduling more daily trips per vessel or deploying additional vessels.
- **Bridging solution while pipelines are developed.** The Orbiter can be utilised while pipelines are under development, ensuring injection as soon as reservoirs are deemed viable.
- **Connecting stranded emitters.** Land-locked emitters or emitters who are not connected to CO<sub>2</sub> pipelines can utilise the Orbiter as a last-mile service, ensuring all emitters can contribute to the emerging CCS value chain.

**KEY PROJECTS**

- Nebula Energy is a member of the Indonesia CCS Center, working with government and industry partners to enable regional hauling of CO<sub>2</sub> in Southeast Asia.
- The Nebula Team has developed two Orbiter facilities for LNG transportation
- The Orbiter is modular, able to be deployed for small-volume injection tests and scaled up for commercial-scale, continuous injection.

**KEY DATA**

TRL	9 for LNG	Number of Commerical Units (LNG)	2
Flexibility	Operational capacity can be increased and decreased by adding ISOs and vessels	Scalability	The Orbiter can scale from injection testing to commercial-scale operations
Target Industries	LNG, CO <sub>2</sub> , CCUS		



[sales.solartronisa@ametec.com](mailto:sales.solartronisa@ametec.com)

[www.solartronisa.com/industries/clean-energy](http://www.solartronisa.com/industries/clean-energy)

**SUMMARY**

Solartron ISA is the leading supplier of wellhead flow meters for the Oil & Gas Industry. From our headquarters in Shildon, Co. Durham, UK, we design, manufacture and support equipment used for flow measurement applications across the globe. With key applications including multiphase measurement of wet gas in gas condensate fields and injection measurement for gas lift or water/inhibitor injection for subsea oil or gas developments, Solartron ISA is now introducing its range of CarbonStream CO<sub>2</sub> Flow Meters.

Operating in either gas or dense phase, our CarbonStream flow meters provide high accuracy and reliable flow measurement data within the harshest of remote, offshore and subsea environments. CarbonStream is supplied with differential pressure and temperature sensors and onboard flow computer (with pre-programmed Equations of State), providing a low-maintenance, flexible and space-saving solution for CO<sub>2</sub> measurement.

**BENEFITS**

**Topside meter**

- Plug and play with hazardous area flow computer (ATEX Ex approved). Low energy – ideal for remote locations. Perfectly suited for unmanned facilities with low power needs (can be solar powered) plus both Ethernet and RS485 communications.
- High accuracy, real time mass flow, differential pressure, pressure and temperature outputs. Low maintenance with no need for through life recalibration (Venturi technology with high performance instrumentation).

**Subsea Meter**

- Highly reliable meter designed for up to 3,000m installation depths. The meter has fully redundant sensors and electronics providing a minimum design lifespan of 25 years.
- The meter comes with built in Equations of State which can be remotely updated during its life as process conditions change. With low power requirements the meter comes with SIIS Level 2 Canbus and Modbus (485) communication outputs.



**KEY DATA**

TRL	5	Capture Rate Range (tpd)	Duplex or better	Design Life?	Better than 25 years
Typical Uncertainty (95% Confidence)	Better than +/- 2%	Turndown (typical)	8:1		
Target Industries	CO <sub>2</sub> Transport and Storage – both gas and dense phase measurement				

# STORAGE





 [gianluca.difederico@bakerhughes.com](mailto:gianluca.difederico@bakerhughes.com)

 [www.bakerhughes.com](http://www.bakerhughes.com)

### SUMMARY

In geological sequestration, completion integrity for any well penetrating the target storage interval is key to maintaining storage integrity over the life of the project. Chemical corrosion inhibitors and reservoir’s environmental factors can be damaging to elastomer seals over time. The most common sealing elastomers in the industry today often force a choice between effectiveness at low temperatures or chemical compatibility with corrosion inhibitors. Aptum™ seal systems, along with industry-leading packers such as the Premier™ NXT removable production packer, perform at lower, more appropriate temperatures for CCUS and yet maintain excellent chemical compatibility and mechanical properties. With Aptum™ seals in the completion, operators can better protect their metal tubulars and equipment without fear of elastomer degradation.

### BENEFITS

- Delivers high performance across a wide temperature range
- Compatible in a range of environments including corrosion-inhibited fluids and reservoir fluids
- Resistant to sour conditions
- Single compound simplifies material recommendations and testing for well planning across all seals including packing elements, O-rings, and bonded seals
- Extends life of seal, further improving reliability
- Meets ISO 23936-2 and API 11D1 standard

### KEY DATA

TRL	9
-----	---

### TECHNOLOGY DESCRIPTION

In typical well completions, the injection or monitoring tubing string is isolated from the well casing by a production packer. This packer creates a mechanical anchor and a seal between the tubing and casing. The four main elastomers currently used in these packer element systems to seal between the tubing and the casing are Nitrile (NBR), hydrogenated Nitrile (HNBR), Aflas (FEPM), and Viton (FKM). These elastomers provide an excellent range of capabilities for most applications. However, in each case, there are trade-offs, which can introduce risks

and costs to an operation. For instance, NBR has balanced mechanical properties and performs well even at lower temperatures. However, its chemical resistance, particularly to corrosion inhibitors, is quite low. Aflas, on the other hand, is excellent for use in many inhibited brines, but has significant limitations in lower temperatures. Baker Hughes set out to develop a balanced element system that could be used confidently in a broader range of applications – carbon storage being a prime example.

MATERIALS	TEMPERATURE 40 °F (4 °C)	TEMPERATURE 350 °F (177 °C)	INHIBITED BRINE >200 °F (93.3 °C)	BROMIDE RESISTANCE	OIL-BASED MUD RESISTANCE	H <sub>2</sub> S RESISTANCE >10%	BALANCED MECHANICAL PROPERTIES	PRODUCED RESERVOIR FLUIDS
Aptum Seal	○	○	○	○	○	○	○	○
Nitrile (NBR)	○	X	X	X	○	X	○	X
Hydrogenated Nitrile (HNBR)	○	○	X	X	○	X	X	○
Viton (FKM)	○	○	X	X	○	○	○	X
Aflas (FEPM)	X	○	○	○	○	○	○	○

Due to excessive swelling, limit exposure to oil-based mud (OBM) during run-in

Due to excessive swelling, O-rings and packing elements require back-up mechanisms to reduce extrusion

Aptum™ seals are compatible with a range of industry standard corrosion inhibitors while still maintaining sealing capabilities in low downhole temperatures.

Carbon storage applications can create corrosive environments when CO<sub>2</sub> becomes mixed with water and other fluids in the wellbore. Completion equipment can often be exposed to hydrocarbons, formation water, CO<sub>2</sub> and a host of other corrosive fluids. A common and effective way of combating this corrosion is to treat the completion fluids with corrosion inhibitors. These corrosion inhibitors protect the metallic components of the completion including the casing, tubing, and packer body. However, they can also degrade the elastomer. As mentioned earlier, elastomers with excellent compatibility with inhibited fluids often have temperature limitations.

Many target formations for sequestration are shallow and have lower temperatures, making them difficult applications for elastomers such as Aflas. Add the potential for significant cooling during various phases of CO<sub>2</sub>-injection operations, and a new solution is needed. Aptum™ provides excellent performance at 4 °C (40 °F) yet maintains long-term compatibility with bromide- and chloride-inhibited brines.

When used as a part of the Premier™ removable production packer, Aptum™ seals enable a secure seal between the tubing and the casing, create a reliable mechanical anchor for the tubing string throughout extreme temperature and pressure changes, and is easily removed from the well for workover or plug and abandonment activities.

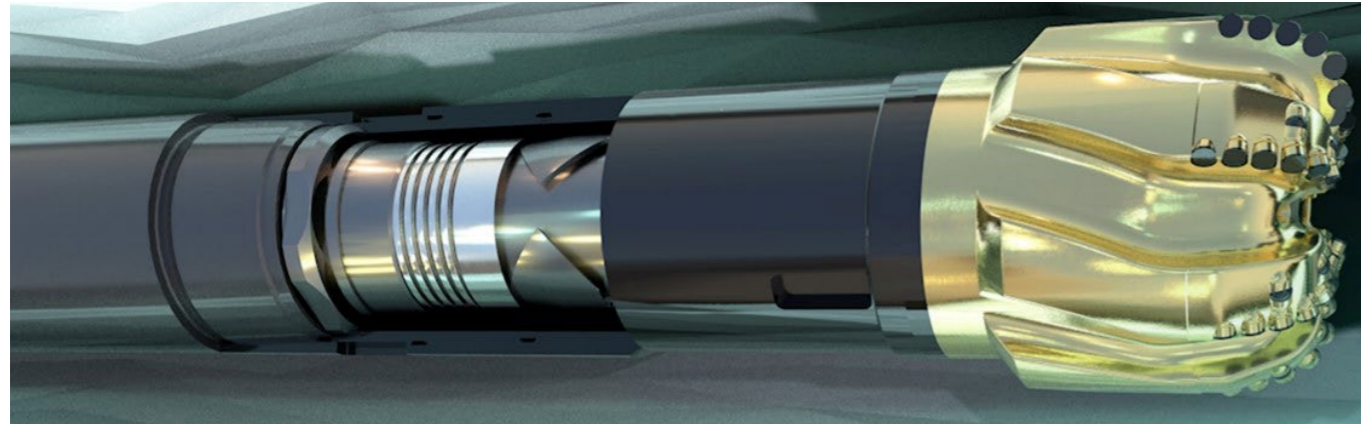

[gianluca.difederico@bakerhughes.com](mailto:gianluca.difederico@bakerhughes.com)

[www.bakerhughes.com](http://www.bakerhughes.com)

### SUMMARY

Seal integrity is key to the success of any geological sequestration project. Along with the logging and measurement technology, taking physical cores is one of the best ways to characterise these structures. Core samples retrieved with traditional coring systems can often break and become jammed or lost in a hole. Jams and poor core quality can lead to re-runs that incur significant additional cost. The CORTIVA™ coring system improves efficiency and de-risks core recovery through the use of a fully-closed and jam-mitigating core barrel. By combining these key features, CORTIVA™ shortens the time and costs required to cut and retrieve a core sample by ensuring the whole core section is retrieved safely in a single trip.

### BENEFITS

- Core longer even in fractured or other jam-prone formations by neutralising up to two jamming events
- Full-closure catcher completely seals inner tube to prevent loss even when the core is unconsolidated
- The HT30™ Max core barrel system delivers larger, longer samples than other systems
- Unobstructed ‘slick’ entry eliminates risk of jam at core’s centre

### KEY DATA

TRL	9
-----	---

### TECHNOLOGY DESCRIPTION

Core jamming during coring operations and/or loss of friable core material during trip-outs leads to additional coring runs, resulting in increased rig time and cost. Jams that occur inside the inner tube of a core barrel can often be mitigated by certain jam-mitigation techniques, allowing coring to continue. However, jams that occur in the core catcher, provoked by the mechanical interaction of the core with the catcher mechanism, would not be mitigated by such anti-jamming technologies. These typically occur in formations that are a mixture of fractured (jamming-prone) and friable rock. This type of complex, coring application demands technologies beyond what is currently available in the market. Competitors have either standalone jam mitigation systems for jam-prone formations, or full-closure catcher systems for unconsolidated/friable rock.

Baker Hughes combines the benefits of various technologies to improve the efficiency of coring operations in complex formations. With its CORTIVA™ full-closure system with jam mitigation technology, Baker Hughes combines the JamBuster™ jam mitigation coring system

and the HydroLift™ full-closure catcher system—industry standards for jam mitigation and recovery of friable rock to improve the efficiency and recovery of high-quality core in complex fractured and friable formations.

The Baker Hughes patented JamBuster™ system neutralises jams inside the inner tube through concentric inner core barrel sleeves that automatically telescope if a core becomes jammed in the core barrel, allowing coring to continue without interruption. The HydroLift™ system efficiently recovers high-quality, intact core samples collected in soft, or unconsolidated formations. The system’s slick, unobstructed entry eliminates the risk of jamming at the core catcher for the incoming core, while the full closure mechanism secures the core, thus preventing loss of friable/loose formation during trip-out.

The CORTIVA™ full-closure system with jam mitigation technology is also integrated with HT30™ Max core barrel system to deliver an unmatched core size. It also reduces core acquisition costs by acquiring longer, high-quality core samples per run, even in harsh environments.





## SUMMARY

Monitoring seismicity is essential to guarantee the integrity of geological sequestration reservoirs and caverns. In terms of physical integrity, seismicity in the cap rock is an indicator of the risk of catastrophic failure. At the reservoir scale, seismicity at faults can identify the reactivation by fluid injection or that they provide a pathway to the surface for the stored fluids. With more public attention towards induced seismicity and environmental impact of human activity, reputational integrity is becoming as important as physical integrity. It is therefore becoming essential to detect growing activity trends before critical situation happens to support operators' injection program. Baker Hughes provides the whole range of customised microseismic services and instrumentation to provide lifetime monitoring of CCS assets.

## BENEFITS

- Maximize storage capacity within safety limits
- Compliance with regulations
- Monitor structure integrity (cap-rock & faults)
- Distinguish induced versus natural seismicity
- Avoid water breakthrough

## KEY DATA

TRL	9
-----	---

## TECHNOLOGY DESCRIPTION

The range of the monitoring solution can be described in 3 distinct stages that can be performed as a whole or as independent services.

### NETWORK DESIGN

In this phase, consideration is given to the project's constraints (regulatory, geological, operational and logistical) and advanced modelling is used to determine the most cost-effective network that will meet the project's objectives. This network can consist of a specific technology (surface or downhole solutions with analogic geophone or fibre optics) to be deployed, but can also have a combination of them to benefit from their different capabilities.



### INSTALLATION AND MAINTENANCE

Baker Hughes ensures supply of all the required instrumentation: surface sensors, shallow buried sensors (100 m), borehole sensors, surface electronics, fibre optics, digitizers, and fully equipped seismic cabinets. Where not internally developed, Baker Hughes works with trusted suppliers with long-term relationships to develop reliable hardware (Mean Time Between Failures of more than five years) with advanced capabilities.

Baker Hughes installs and maintains all the instrumentation, including borehole sensors. The requirement for preventive maintenance is extremely low (one visit a year at most). This allows us to operate sites all over the world. Most of the sites are totally autonomous, relying on solar panels for power and 4G networks for communications.

### MONITORING - PROCESSING

A dedicated team of experts processes the data and reports on the seismicity through a dedicated web portal. The portal allows the operator to visualise the seismicity in two-dimensions (2D) or 3D along with the well trajectories and formation interfaces and offers statistical analysis capabilities. It also plays the monitoring network's state of health and expected sensitivity in real time. Pressure and/or flow rate curves can be displayed along with seismic rates to easily relate any seismic activity to its probable cause.

Automation of the process can be utilised to enhance the processing solution by adding 24/7 services such as traffic light systems that will alert the operator when critical seismicity is reached, and the prediction of the level of seismic risk for the upcoming hours using machine learning.

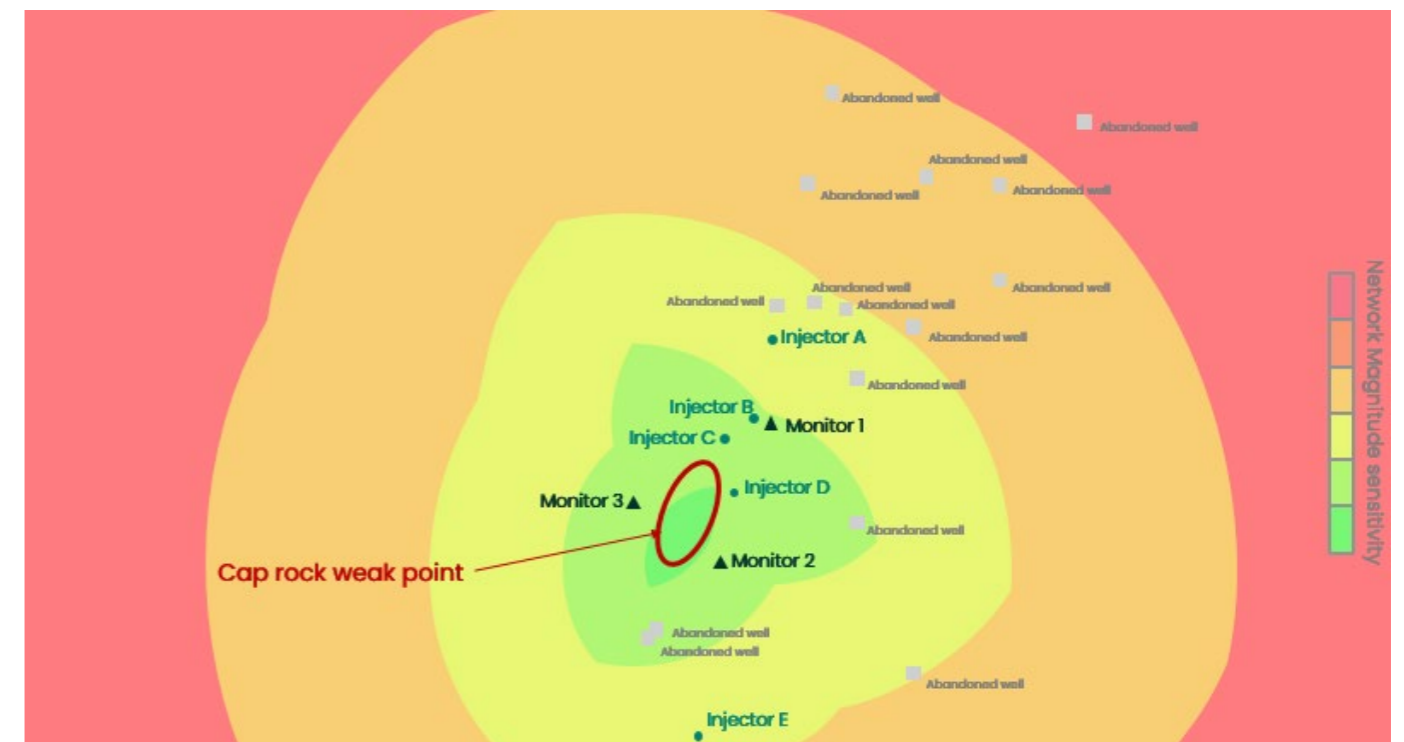

<sup>1</sup> tedTemperatures Under Hydrogen Conditions", SEAFOM Industry Meeting (Dec. 2012)



[ccus@bakerhughes.com](mailto:ccus@bakerhughes.com)

[www.bakerhughes.com](http://www.bakerhughes.com)

### SUMMARY

Drilling exposes different geologic features and zones of the reservoir. During well construction, casings and liners are cemented in place to create a barrier between the wellbore and formation, allowing the operator to isolate a specific zone of the reservoir for production or injection.

Achieving zonal isolation is important as not only can it be expensive to repair, but it can also lead to the uncontrolled release of CO<sub>2</sub> to other formations and/or the atmosphere. Additionally, lack of zonal isolation may cause well operational problems, such as sub-optimal injection, due to CO<sub>2</sub> migration into unintended formation intervals. In CO<sub>2</sub> injection wells, zonal isolation can be especially difficult to achieve and maintain due to the high pressure and corrosive nature of supercritical CO<sub>2</sub>, which poses additional risks to cement integrity.

The PermaSet slurries are fit-for-purpose, corrosion-resistant cement systems designed primarily for carbon dioxide (CO<sub>2</sub>) and hydrogen sulfide (H<sub>2</sub>S) environments. They are used in primary and remedial cementing operations. They are compatible with most Baker Hughes additives and can be designed for use in virtually any well condition anywhere in the world. PermaSet cement slurries are part of the Baker Hughes Set for Life family of cement systems that isolate and protect the targeted zone for the life of the well. These slurries can be blended with other systems in this family to help ensure long-term zonal isolation. Baker Hughes solves cementing problems at the wellhead by taking CO<sub>2</sub>- and H<sub>2</sub>S-resistant cement systems out of the laboratory and into the real world.

### BENEFITS

- Improves the cement's resistance to attacks from CO<sub>2</sub>, H<sub>2</sub>S, magnesium, sulfate, and other corrosive fluids.
- Eliminates weak points and reduces carbonation with negligible Portlandite content.
- Delivers cement with lower permeability than conventional systems.
- Reduces shrinkage and cracking with a lower heat evolution during setting.
- Provides good mechanical properties.
- Uses real-time well conditions to determine the final slurry composition.

### APPLICATIONS

- Conventional primary and remedial cementing operations in CO<sub>2</sub> and H<sub>2</sub>S environments
- Ideally suited to Carbon Capture and Storage Wells (CCS)
- Compatible with virtually all API and ASTM cements and most cement additives

*This page has been intentionally left blank.*

### KEY DATA

TRL	9
-----	---



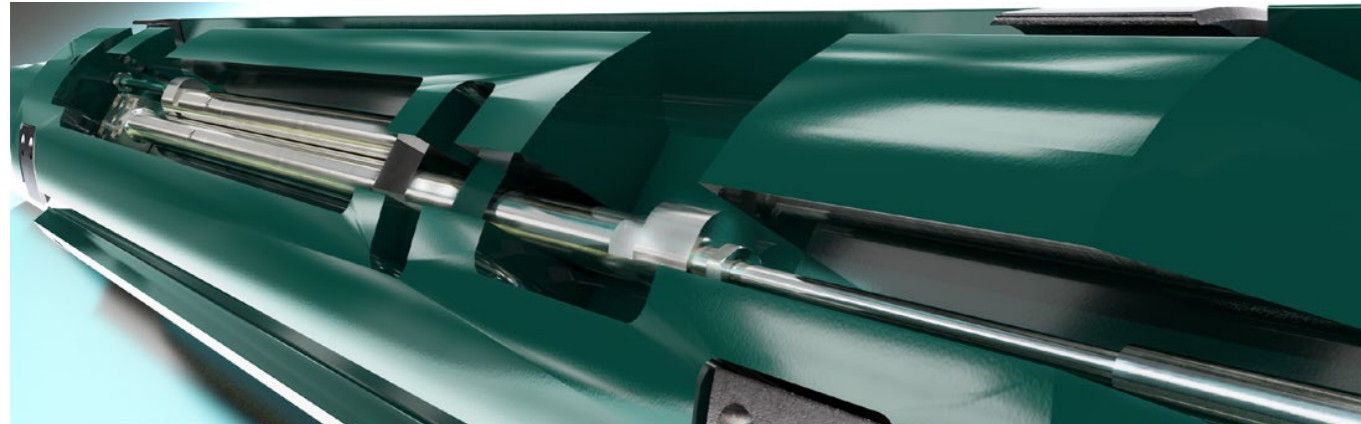

[gianluca.difederico@bakerhughes.com](mailto:gianluca.difederico@bakerhughes.com)

[www.bakerhughes.com](http://www.bakerhughes.com)

### SUMMARY

Well-known pressure and temperature are key to proper functioning throughout a CO<sub>2</sub> storage system. For most applications, the best way to monitor these parameters is with permanent downhole gauges (PDHGs). These gauges can be used as a standalone means of measurement or as calibration for a fibre optic-based or other extensive measurement system. Baker Hughes leverages the quality and performance of the SureSENS™ line to execute integrated monitoring solutions that combine point gauges, fibre optics, along with periodic means of measurement such as wireline logging data.

### BENEFITS

- Provides superior reliability in long-life and/or demanding (high-pressure and high-temperature) applications
- Derives finest pressure/temperature measurement resolution attainable
- Deploys multiple gauge combinations on a single standardised carrier
- Eliminates the need for additional splices, increases reliability, and reduces installation time through unique construction configurations with fewer connections
- Deploys multiple gauges, flowmeters, and valve positions to provide redundant readings
- Serves as platform for future developments

### KEY DATA

TRL	9
-----	---

### TECHNOLOGY DESCRIPTION

The SureSENS™ QPT ELITE gauge for permanent downhole installations measures static and dynamic pressures and temperatures while introducing a step change in reliability and accuracy. The gauge is qualified for operation at pressures up to 30,000 psi and temperatures up to 225 °C (437 °F). The static and dynamic pressure information obtained can be used to determine the effects of injection and plume growth on monitoring wells, monitor injection characteristics, and provide input or validation to reservoir models. The SureSENS™ QPT ELITE gauge includes the new ELITE electronics package, built upon Baker Hughes' industry-leading STAR hybrid electronic package design. The ELITE electronics package incorporates an application-specific integrated circuit (ASIC), providing a new level of reliability to the industry. Baker Hughes provides three configuration options—single, dual, and triple gauge. The single-gauge configuration is an economical option that will also permit the smallest possible running diameter for a streamlined, slim-hole gauge carrier. A dual-gauge configuration provides isolated operational redundancy of electronics and transducer at any given installation point. Each gauge in a dual package operates individually, providing independent measurements for data redundancy and integrity verification. The triple gauge option can offer

redundancy or be ported to record three independent pressure measurements. The shorter carrier for a side-by-side triple-gauge assembly also retains a slim hole running outside diameter.

For applications requiring long active life and high data accuracy, even in demanding high-pressure/high-temperature type environments, the SureSENS™ QPT ELITE gauge system provides a flexible and reliable solution.

Being highly robust, the SureSENS™ QPT ELITE gauge maintains mechanical integrity by deep-penetration and high vacuum, electron-beam fusion welds, without the need for filler material. The gauge pressure interface connection to the carrier is dual metal-to-metal gas tight seal that can be externally tested in the direction in which it will experience pressure, eliminating the need for an internal pressure test tool. The TEC's primary seal is a dual metal-to-metal pressure-testable interface. The mechanical package is completely integrated into the gauge assembly, which eliminates the requirement for external Y-block components.

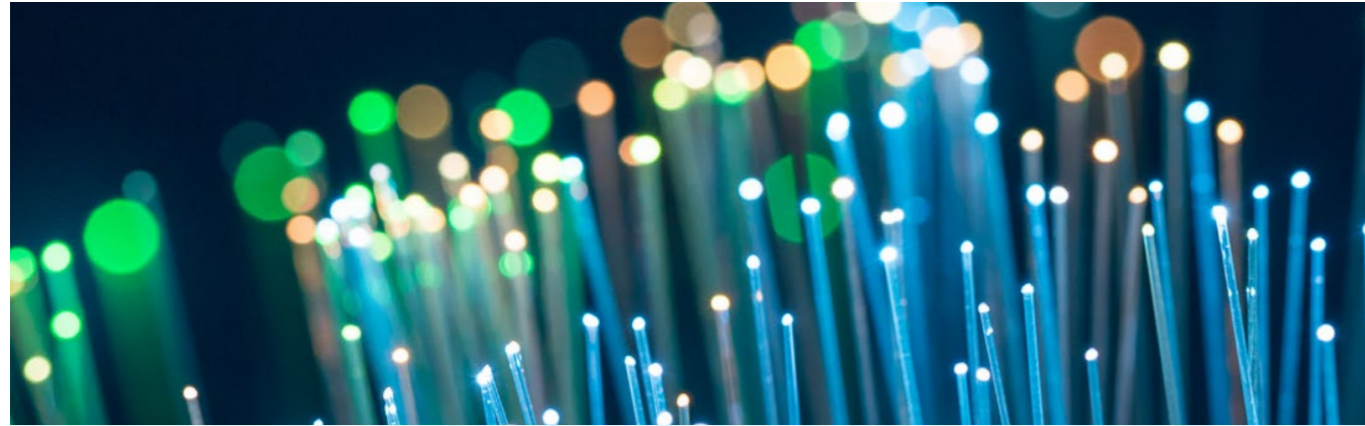

Gauge Carrier configured with QPT ELITE permanent downhole gauge

SUREVIEW™ WITH COREBRIGHT™  
OPTICAL FIBRE

 [gianluca.difederico@bakerhughes.com](mailto:gianluca.difederico@bakerhughes.com)

 [www.bakerhughes.com](http://www.bakerhughes.com)

## SUMMARY

Reliable downhole measurement of well and reservoir parameters is imperative to the success of geological sequestration projects. Baker Hughes is uniquely positioned to holistically address the monitoring challenges. Baker Hughes leverages a broad portfolio of technology and experience across permanent downhole gauges, microseismic monitoring, wireline monitoring, and fibre optic solutions. Specifically, fibre optic monitoring is an effective solution to gather a range of real-time data downhole. These systems can provide distributed temperature, acoustic & strain measurements, transmit point gauge data, and capture seismic measurements for use in vertical seismic profiling. The majority of traditional downhole fibre optic installations are intended for 10-20 years of hydrocarbon production life. However, the geological sequestration projects can require much longer service life. SureVIEW fiber optic cable utilises proprietary CoreBRIGHT fiber formulated specifically for long-life downhole applications and has unique resistance to common hydrogen darkening failure.

## BENEFITS

- Collect multiple measurements with a single cable including distributed fibre optic sensing, pressure/temperature gauges for well integrity, compaction monitoring, and seismic data.
- Utilises CoreBright™ hydrogen resistant fibres to limit the effects of hydrogen darkening
- Cable is clad with robust Inconel 825 corrosion-resistant nickel alloy for maximum protection against chemicals, abrasion, crimping and crush.
- Continuous cable with no orbital welds
- Fibre In Metal Tube (FIMT) utilises continuous (splice-free) fibres throughout
- Equipped with excess fibre to ensure that no strain is transferred to the optical fibre core during deployment or operation. Excess fibre compensates for thermal expansion, as well as tubing stretch.

## KEY DATA

TRL

9

## TECHNOLOGY DESCRIPTION

SureVIEW™ downhole cable by Baker Hughes uses CoreBright™ optical fibre, which leads the industry in hydrogen darkening resistance, a leading cause of failure for fibre optic systems over time. CoreBright™ fibre is constructed from pure silica that minimises hydrogen darkening. The cable also includes a layer of hydrogen-absorbing gel. This combination provides the industry's best protection against hydrogen darkening.

Fabricating a downhole optical cable with the performance and reliability demanded by our industry requires a sophisticated understanding of fibre design, fibre coatings, cable manufacturing processes, and cable construction.

Fibres are typically coated, often with carbon, to prevent this hydrogen darkening. However, over time, this coating can break down or suffer from uneven application during manufacturing. A well applied coating will likely break down in about 20 years, particularly at higher temperatures (above 150 °C). CoreBright™ fibre offers its extended lifetime through a simple principle: instead of attempting to avoid hydrogen damage by trying to block hydrogen, CoreBright™ optical fibre avoids the hydrogen damage by preventing the reaction between the SiO<sub>2</sub> structure of the optical fibre and the hydrogen. In addition, Baker Hughes' fibre optic cables are fitted with hydrogen scavenging gels to further reduce darkening risk.

In this way, Baker Hughes' solution is unique: the fibre will not darken, and reliable readings over the full life of the installation are assured. Independent testing has concluded that CoreBright™ optical fibre is the only fibre in the industry that is suitable for harsh downhole environments over a long duration. It is the only known fibre that was designed for, and has demonstrated, long-term immunity to first and second-order hydrogen darkening effects.

SureVIEW™ fibre optic cables, powered by CoreBright™ fibre, have been installed in over hundreds of wells worldwide. As of today, there are no instances of hydrogen darkening ever reported.

High reliability and longevity enable the use of fibre optic measurement in more applications particularly behind the casing where workover is likely impossible. Baker Hughes' SureVIEW™ downhole cable is expected to improve data quality and facilitate better decision-making in geological sequestration today.

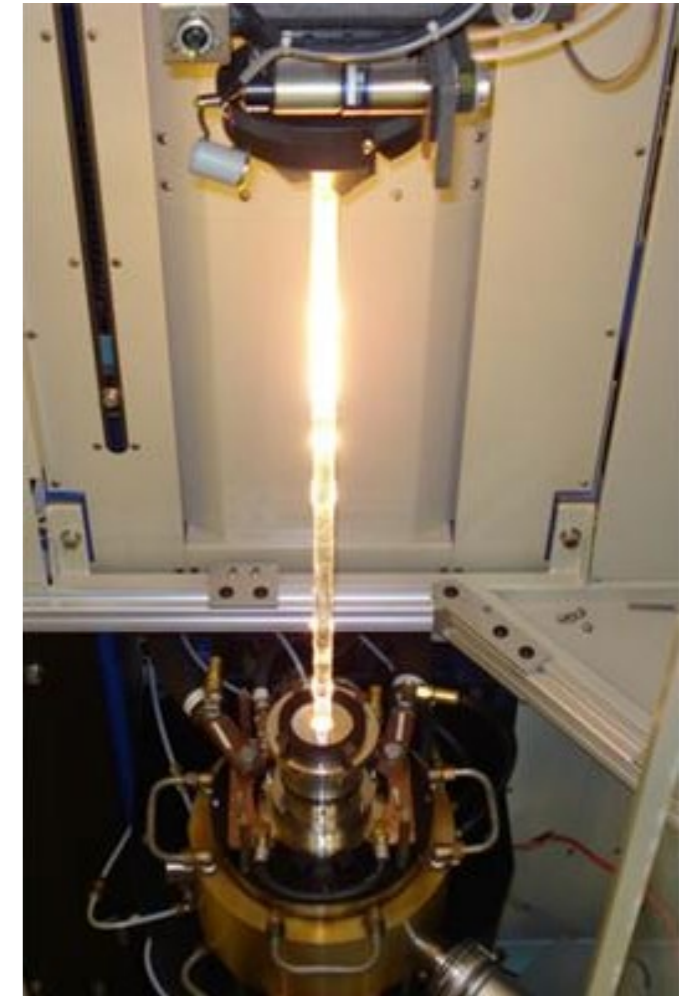



[carbfix@carbfix.com](mailto:carbfix@carbfix.com)

[www.carbfix.com](http://www.carbfix.com)

### SUMMARY

The Carbfix process captures CO<sub>2</sub> and turns it into stone underground in under two years through technology that imitates and accelerates natural processes, providing a permanent carbon storage solution. Carbfix is the world's first organisation dedicated to facilitating and implementing carbon capture and mineral storage (CCMS) worldwide. Robust research and innovation based on subsurface geochemical processes laid the foundation for injection of dissolved CO<sub>2</sub> into mafic and ultramafic formations for efficient mineralisation. To date, such approach is the safest and fastest carbon capture and storage (CCS) method applicable at industrial scale. Carbfix can adapt its well-established technology to a range of point source emissions as well as direct air capture technologies with a portfolio of solutions. Carbfix is also pioneering mineral storage in connection with direct air capture technologies as well as large scale hubs that can receive transported CO<sub>2</sub>.

### BENEFITS

- Safe. The risk of leakage is fully eliminated by dissolving CO<sub>2</sub> in water
- Cheaper than alternative solutions, has lower up-front capital costs and financial risks
- Environment-friendly. The process imitates and accelerates nature's way of storing CO<sub>2</sub> in rocks with no chemicals other than water
- Permanent. Minerals are stable for thousands of years limiting the need for long term monitoring
- Highly flexible with respect to capture technology used, injection strategy and up scaling
- Dissolved CO<sub>2</sub> has less stringent requirements for pipe and casing material than pure CO<sub>2</sub>
- Able to provide added value through co-capture of other soluble industrial gases (SO<sub>x</sub>, NO<sub>x</sub>, H<sub>2</sub>S, F)

### KEY PROJECTS

- **Silverstone<sup>1</sup>**: Funded by the EU Innovation Fund, Silverstone is a point source CO<sub>2</sub> capture system. The system captures up to 0.034 Mtpa CO<sub>2</sub> from geothermal powerplant fluids for immediate mineralisation.
- **CODA Terminal<sup>1</sup>**: A scalable cross-border carbon transport and mineral storage hub funded by the EU Innovation Fund and located in Iceland, CODA will receive CO<sub>2</sub> captured from industrial sites in Europe. The fully operational capacity will sequester 3 Mtpa CO<sub>2</sub> by 2030-2034.
- **Mammoth & Orca**: Collaboration with DAC industry leader Climeworks. The two largest DAC facilities in the world (0.036 and 0.004 Mtpa respectively) deliver all captured CO<sub>2</sub> to Carbfix for mineralisation.
- **Seastone**: Addressing the significant water demand, Carbfix has developed the scientific basis for using seawater to dissolve CO<sub>2</sub>. Expanding the applicability of the technology to water scarce, coastal, and offshore regions. A world's first, Carbfix has co-injected CO<sub>2</sub> since 2023 with this pilot.

### KEY DATA

TRL	9	Capture Rate Range (tpd)	~	Modular (Y/N)	Yes
Source CO <sub>2</sub> Purity Range	40 - 99.5%	Energy Consumption (GJ/tCO <sub>2</sub> )	~	Capture Efficiency (%)	100%
Number of Commercial Plants	3	Number of Pilot Plants	6		
Target Industries	Direct Air Capture, Steel, Cement, Aluminum				

<sup>1</sup> The Silverstone and CODA projects are a part of the European Innovation Fund

### TECHNOLOGY DESCRIPTION

#### BACKGROUND

Trees and vegetation are not the only form of carbon drawdown from the atmosphere. Vast quantities of carbon are naturally stored in rocks. Carbfix imitates and accelerates these natural processes, offering a permanent and safe carbon sink. The technology provides a complete carbon capture and injection solution, where CO<sub>2</sub> dissolved in water is injected into the subsurface where it reacts with favorable rock formations, such as basalts, to form solid carbonate minerals via natural processes. For the Carbfix technology to work, one needs to meet three requirements: suitable rocks, water, and a source of carbon dioxide.



#### CARBFIX METHOD

Carbonated water is acidic. The more carbon one can pack into water, the more acidic the fluid will become. Carbfix's carbonated water reacts with rocks underground and releases available cations such as calcium, magnesium and iron into the water stream. Over time, these elements combine with the dissolved CO<sub>2</sub> and form carbonates, thus filling up the empty space within the rocks. The carbonates are stable for thousands of years and can therefore be considered permanently stored. The timescale of this process initially surprised scientists. In the Carbfix pilot project, it was determined by a suite of chemical and isotropic tracers that at least 95% of the injected CO<sub>2</sub> mineralised within two years, much faster than previously thought. Once the mineralisation process is confirmed, further monitoring is not required. The injected carbonated water is denser than the surrounding water in the geological formation, and therefore has the tendency to sink after it has been injected. This differs from more conventional methods of carbon capture and storage, which depend on cap rock to prevent possible leakage of gaseous CO<sub>2</sub> injected into deep formations that are overall not very reactive. Young basaltic rocks are highly fractured

and porous such that water seeps easily through the interconnected cracks and empty spaces underground. It has been estimated that after injecting 100,000 tons of gas into the Hellisheidi basaltic reservoir only 0.05% of the storage space was filled with solid minerals. The global storage potential of such favourable formations (Carbfix atlas) is greater than the emissions of the burning of all fossil fuels on Earth. It is estimated that Europe could theoretically store at least 4,000 billion tons of CO<sub>2</sub> in rocks, while the United States could store at least 7,500 billion tons.

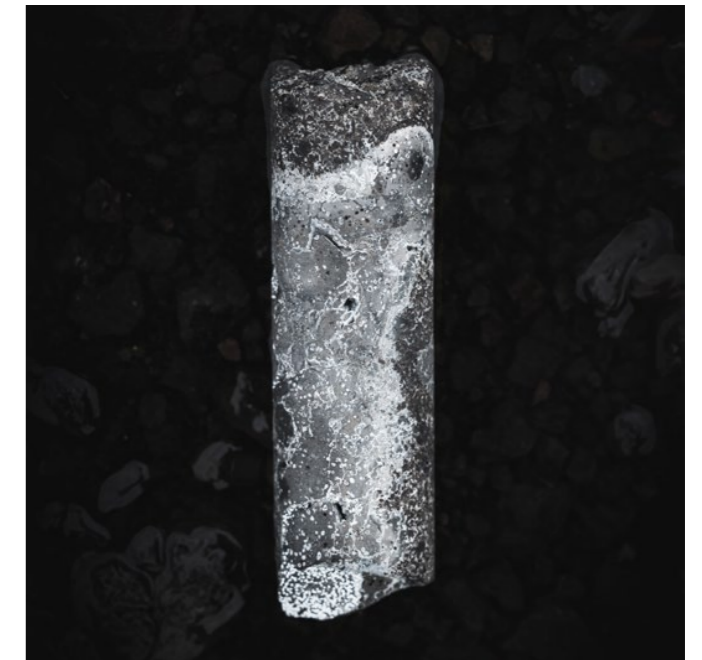

#### CARBFIX FOOTPRINT

The Carbfix technology requires significant amounts of water, which is co-injected into the subsurface with the CO<sub>2</sub>. To address this, Carbfix has developed the scientific basis for using seawater, a near unlimited resource, to dissolve CO<sub>2</sub> prior to injection, thus expanding the applicability of the technology to water scarce regions, coastal and offshore areas. The CO<sub>2</sub>-Seastone pilot project in SW Iceland has been injecting CO<sub>2</sub> since Q4 2023.





EXPRO

# CaTS EMX WIRELESS MONITORING SYSTEM



wireless@expro.com

www.expro.com

## SUMMARY

For clients working across the entire well life cycle, Expro is one of the visionary full-cycle energy services expert offering novel, insightful solutions, dependable competency and award-winning safety. Expro's wireless downhole monitoring system uses the world-leading CaTS™ EM technology to transmit high resolution pressure and temperature data from suspended and abandoned wells.

CaTS™ enables suspended and abandoned wells to be converted into high-value long-term monitoring assets, for many years after the rig has left location. Dynamic reservoir pressure responses are monitored during drilling, testing and CO<sub>2</sub> injection in the field to capture cross-field interference and long-term pressure data. The data provides critical information about the connected volumes to characterise the reservoir, validate subsurface models and refine the field development plan. The system can be run on its own or as part of a DST test string and the Duplex functionality allows for optimal battery management, ensuring the right data is delivered at the right time.

## BENEFITS

- Doesn't require tubing or completion string in the well.
- Signal is not attenuated by cement or bridge plugs making it ideal where a well is to be abandoned or suspended.
- Uses the industry leading quartz crystal sensor.
- Expanded P&T operating envelope.
- Up to 45x improvement in data volume and 4x improvement in system life compared with the previous generation.
- Uses market leading through seawater communications system.
- Integration with other devices such as acoustic DST SRO system, valves, hangers, surge chamber, TCP and fluid sampling.
- Flexibility to change gauge data transmission rate from surface to align with test objectives.
- Request historical data for periods of interest.
- Request on-demand readings.
- Compatible with third party test strings, completion components and acoustic SRO systems.
- Diagnostic functionality to check tool performance.
- Ability to optimise system performance parameters post-installation.

## KEY DATA

TRL

9

## TECHNOLOGY DESCRIPTION

### MONITORING APPLICATIONS

#### INTERFERENCE TESTING

Instrumenting an abandoned or suspended well with a CaTS system enables interference testing within the reservoir during appraisal testing, extended flow/injection testing and into first CO<sub>2</sub> injection.

This pressure data gives a better understanding of the reservoir characteristics and connected volumes, which will help with field development plans, aid optimal well placement and provide data to feed into plume migration and subsurface models.

This application is commonly used for exploration and appraisal campaigns in the oil and gas industry and has immediate synergies when evaluating new saline aquifers as CO<sub>2</sub> stores.

The gauge systems can be run in untested exploration wells or appraisal wells that have been tested. Equally the gauges can be used in saline aquifer or depleted oil and gas fields, and are suitable for lateral interference monitoring in the field or vertical interference monitoring between different zones and intervals.

#### LONG-TERM PRESSURE BUILD-UP / FALL-OFF

CaTS gauges can be installed in appraisal wells that are either production tested or injection tested. The gauges remain in the well after the test has been completed to gather reservoir pressures and temperatures after the well has been suspended or abandoned.

This application allows the rig to move location in a timely manner following the end of the test, and the data provides a deeper look into the reservoir to evaluate features further from the well bore (far field boundaries, baffles, faults etc.).

This means well testing no longer has to end at well abandonment and the pressure build-ups can be extended from days to years, enabling a greater understanding of the reservoir and a derisking of the field development.



### PRESSURE FRONT AND CO<sub>2</sub> PLUME TRACKING

Once a well is instrumented with a CaTS gauge system, it then becomes a high-value data asset. The pressure and temperature data becomes invaluable during appraisal and development activities within the field and can act as a primary method to detect the pressure front related to injecting CO<sub>2</sub> and the CO<sub>2</sub> plume itself as it moves through the reservoir as operations commence.

The extended battery life of the CaTS EMX system means that gauges installed in exploration and appraisal wells could be used for pressure and CO<sub>2</sub> plume tracking many years into the future.

While seismic monitoring is an established method of detecting plume migration, it is no substitute for actual subsurface data. The downhole gauge data will be used to improve reservoir models and enable more accurate plume tracking as time passes.

### WELL INTEGRITY AND LEAK DETECTION

CaTS gauges can also be installed for well integrity and leak detection purposes. Common application include below plug/packer monitoring, barrier verification, well bore leak detection and behind casing monitoring.

For carbon capture and storage projects, understanding the well and formation integrity is paramount. Instrumenting wells with CaTS gauge could improve the overall Well Integrity Management System (WIMS) by providing accurate data to detect potential leaks in the completion, casing, cement or the formation (e.g. cap rock or overburden).

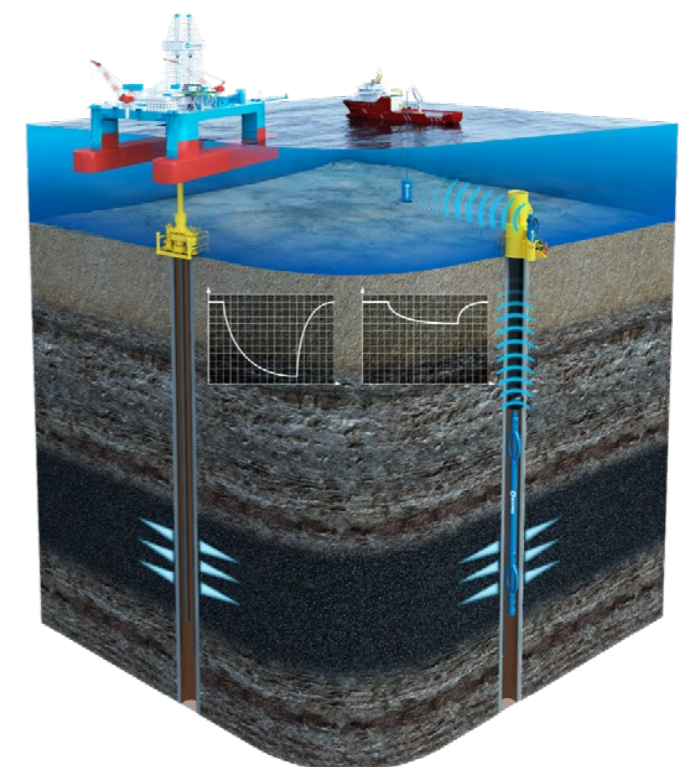

# COLLAR LOAD SUPPORT & FLUID GRIP® TONG



[wellconstruction@expro.com](mailto:wellconstruction@expro.com)

[www.expro.com](http://www.expro.com)

## SUMMARY

To ensure long-term well integrity assurance in carbon storage wells, a very thorough design review is needed for all aspects of the well architecture to ensure integrity is maintained throughout. Often overlooked, improper handling and installation through lack of knowledge, equipment selection, or technology can lead to well integrity issues in carbon storage wells. To combat the acidic and corrosive downhole environments of carbon storage wells, corrosion resistant alloy (CRA) tubulars are often designed into the well architecture to help ensure well integrity is preserved. These elements must be handled and installed carefully as impressions, marks, and cuts from make-up and handling operations can further accelerate corrosion failures on the tubular, while compromising the integrity of the downhole measuring equipment. Expro provides a line of non-marking tubular handling technologies that were designed to eliminate these risks and enhance the integrity of carbon storage wells.

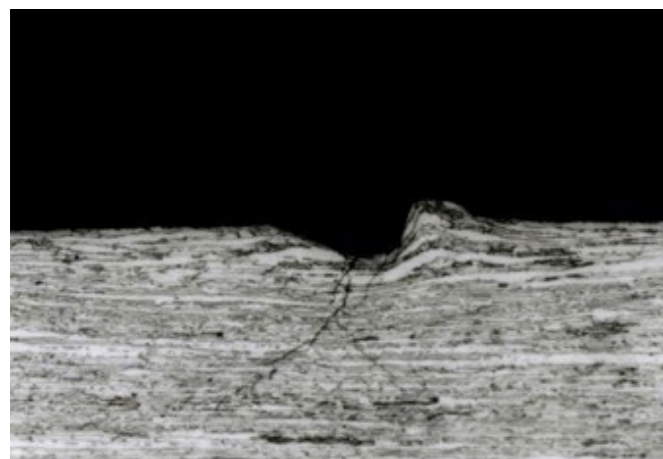

Figure 1 - CRA Tubular Containing Die Mark and Crack Initiation and Propagation



Figure 2 - Screenshot of Expro's iCAM® Intelligent Connection Evaluation System

## KEY DATA

TRL

9

## TECHNOLOGY DESCRIPTION

The design of tubular handling equipment balances the task of supporting the necessary string weight or make-up torques, while minimising the impressions onto the outer surface of the tubular. With the correct handling equipment selection, operators will greatly mitigate risks and maximise the probability of maintained well integrity.

The most ideal solution for handling CRA tubulars is to eliminate surface impressions all together. Non-marking spiders, elevators, and tong systems, not to be confused with low-marking technologies, completely eliminate the risks explained above. Expro's Collar Load Support (CLS™) System uses load transfer bushings that are directly transferred from an elevator to a shock absorbing landing spear system mounted within the rig's rotary. When utilising the CLS™, loads are limited by the bearing capacity of the coupling rather than the tubular slip crush capacity, as often seen with slip type handling equipment. Additional benefits of this system include:

- Eliminating the possibility of slippages due to handling method
- Eliminating iron transfer typically seen with handling systems utilising standard inserts and dies
- Design allows for a large pass-through diameter which can be beneficial for running large OD assemblies and control line clamps
- Ability to run singles, doubles, and stands
- No chance of crushing tubulars as occasionally caused by the radial loads of slip type handling equipment

In addition to the CLS™ system, Expro offers a non-marking tong option, which completes the industry's only tubular running package that truly eliminates the risks of corrosion failures due to iron transfer and impressions from die and insert handling systems. The Fluid Grip® Tong utilises fluid filled bladders and provides a uniform, 360° coverage that conforms to the shape of the tubular outer diameter. This high degree of coverage significantly reduces the stresses imparted to the tubular during make-up and break-out operations, reducing the tendency for distortion and galling. By comparison, stresses imparted by conventional tong systems are localised and significantly higher, in some cases even exceeding the yield strength of the tubular.

Additionally, the integrity of all threaded connections is another critical component in ensuring long-term well integrity. Utilising thread compensation systems can help prevent damage to these connections during stabbing and make-up procedures. Machine learning and big data analytics are now being used to provide automated evaluation of connection make-up data, which improves accuracy, consistency, and reliability in connection integrity assessment. Expro's iCAM® system offers flexible integration with equipment such as power tongs and CRTs to produce optimal connection integrity and accelerate the make-up process, with the potential to reduce personnel on location.

## CHALLENGES AND RISKS

- For carbon storage wells, the significance of long-term well integrity cannot be overstated. With the threat of accelerated corrosion and an increasing pressure regime from CO<sub>2</sub> injection, maintaining mechanical integrity means the absence of significant leakage within the injection tubing and casing. The avoidance of any front-end damage to these CRA tubulars during deployment will help preserve the durability and reliability of these barriers for the entire project life cycle, which can extend to 100 years post-abandonment to meet regulatory requirements.
- During the handling and installation of tubulars, loads are typically transferred to the tubular via hardened dies and inserts, which create impressions on the outer surface of the tubular. This occurs primarily when hoisting and lowering the string, supporting the string in the rotary table and during make-up of additional joints into the string. It is well known that impressions resulting from make-up and installation are common areas for the initiation of corrosion often leading to failure.
- Cold worked CRA tubular materials like 22Cr and 25Cr are commonly used in carbon storage wells. These materials are sensitive to localised impressions as they.
  - Induce localised work-hardening at the root of the impression
  - Create stress concentrations in the gripping areas of the tubing
  - Are preferential sites for corrosion
  - Are especially sensitive to iron transfer
- Figure 1 shows a crack that has been initiated at the site of a die mark resulting from handling a CRA tubular string

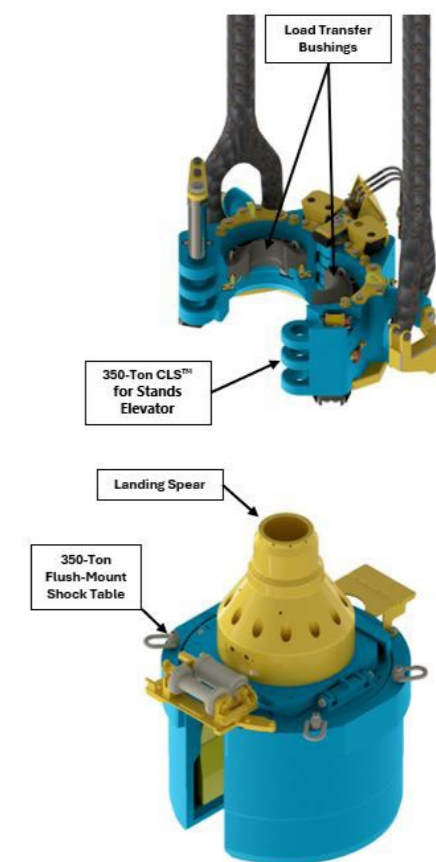

Figure - Expro's CLS™ Non-Marking Handling System



**SUMMARY**

Mangrove Systems provides the leading digital MRV solution for carbon capture & storage (CCS) and carbon dioxide removal (CDR) projects. Mangrove offers robust production carbon accounting that streamlines measurement, monitoring, reporting, and verification for project commercialisation.

Mangrove processes data from multiple sources along the project value chain, aggregating operational and non-operational data and supporting the production carbon accounting required to meet regulatory and commercial reporting requirements to engage government programs (45Q, 45Z, 45V), compliance markets (LCFS, EU ETS, CBAM), as well as the voluntary carbon market (VCM). The platform enables streamlined verification with independent validation & verification bodies (VVB) and simplifies credit issuance and serialization with registries.

Mangrove Systems is trusted by many of the world's largest carbon projects to bring trust, transparency, and integrity to carbon project operations. For more information, visit [www.mangrovesystems.com](http://www.mangrovesystems.com).

**BENEFITS**

- Streamline reporting & ongoing project compliance for voluntary, compliance, and tax programs
- Accelerate the cash conversion cycle of your projects
- Report fully-traceable data for easy project verification via automated registry integrations
- Increase revenue with data-backed environmental attributes
- Conduct production carbon accounting across multiple CO<sub>2</sub> sources and storage points
- Leverage ML-based insights to improve project ROI

**KEY PROJECTS**

- **Summit Carbon Solutions:** An 18+ Mtpa of CO<sub>2</sub> Bioenergy with Carbon Capture & Storage (BiCRS) project in the Midwest US. Mangrove will process data from across Summit's value chain, streamlining verification and commercialisation across monetization pathways.
- **Accend:** A leading project developer in carbon dioxide removal. Mangrove is used to streamline credit origination for over 20 biomass-based carbon removal projects. As of 2023, Mangrove maintains over 30% market share of the global biochar-based carbon removal origination market.
- **Yet to be announced:** A 2+ Mtpa of CO<sub>2</sub> CCS project in the West US.
- **Yet to be announced:** A 300 ktpa+ CCS Project in the South US.

**KEY DATA**

TRL	9
Target Industries	CCS, CCUS, CDR, SAF, Hydrogen

**TECHNOLOGY DESCRIPTION**

**A SOLUTION TO ENABLE COMPLETE TRACEABILITY ACROSS YOUR SYSTEM BOUNDARY**

Carbon projects today are confronted with a rapidly evolving landscape to monetize their efforts. New compliance & tax regimes are emerging. Regulations are evolving on an international level. Reporting requirements for monetisation pathways are increasing in complexity.

To manage this rapidly evolving landscape, carbon projects require a robust digital MRV solution that is:

- **Built for Scale** — allows the platform to scale and support future project arrangements and structures
- **Flexible & Adaptable** — ensures the platform adapts to emerging regulations and value streams
- **Foundational and Secure** — provides a robust system that remains constant, even as the industry, markets, and technologies evolve.

Mangrove Systems offers the leading digital MRV solution for carbon capture & storage (CCS) and carbon dioxide removal (CDR) projects. The solution enables project developers to streamline commercialisation within one central system, powering project developers' ability to monetise project operations and maintain project compliance.

Mangrove aggregates operational and non-operational data from across your project boundary and supports the production carbon accounting required to meet regulatory and commercial reporting requirements to engage government programs, compliance markets, as well as the voluntary carbon market.

**SOLUTION CAPABILITIES**

**Credit enablement & reporting**

Streamline reporting & ongoing project compliance for voluntary, compliance, and tax programs.

- **Reporting Engine:** Ingests operational data to perform calculations for net quarterly mass of CO<sub>2</sub> received, injected, and leaked to generate output reports for compliance & credit enablement reporting.
- **Enable Credit Origination & Credit Management:** Generate reports for 40 CFR Subpart RR (45Q), LCFS CARB, and other programs.
- **Share Data with Value Chain Partners:** Seamlessly share data and key reports with value chain partners and stakeholders for their own reporting & compliance needs. Simplify verification and accelerate the cash conversion cycle via automated registry integrations.

**Chain of custody tracking & mass balance accounting**

Perform production accounting to correctly attribute CO<sub>2</sub> volumes and characteristics back to CO<sub>2</sub> sources.

- **Chain of Custody Tracking:** Track CO<sub>2</sub> as it moves through your value chain to provide a traceable, auditable system for CO<sub>2</sub> management and reporting.
- **Allocation Engine:** Correctly attribute CO<sub>2</sub> back to the source with proportional emissions (losses, leakages, line fill) for net capture calculations.

- **Mass Balance Accounting:** Track commingled CO<sub>2</sub> using a mass balance approach to support downstream commercialisation, reporting, and compliance requirements.

**Validations, insights, and optimisation**

Ongoing monitoring, alerting ensures data and activities are compliant with programs. Leverage ML-based insights to improve project ROI.

- **Data Validations & Quality Control:** Validates data entering the system for completeness, enforcing cleanliness and overall quality assurance across the system.
- **Anomaly Detection:** Ensures ingested data and calculations are compliant with programs and regulations and alerts operators of system anomalies.
- **Optimisation Engine:** Leverage operational data and program scenarios to receive actionable insights to increase revenue.

**KEY BENEFITS**

**Streamline reporting across monetization pathways**

Through a detailed production inventory, Mangrove Systems supports CCS operators in tracking batches of gross CO<sub>2</sub> production and underlying calculations, along with evidence, all in a centralised MRV platform for robust auditability & traceability. The platform generates output reports for compliance (e.g. 40 CFR) reporting & credit enablement (e.g. 45Q, LCFS, VCM) reporting and internal reporting to analyse production, allocations, and commercialisation.

**Accelerate the cash conversion cycle**

Mangrove provides verification bodies (VVBs) & auditors with a central hub to review underlying production data and supporting evidence. By performing upfront validations to ensure data completeness for verification, and centralising data, accounting, and evidence in one accessible location, Mangrove significantly reduces the time and effort required for verification, leading to quicker validation of credits and faster access to revenue for projects. Project developers can then track the real-time position of their verified credit inventory across the full life-cycle (oftakes, orders, and deliveries).

**Seamlessly integrated into your operational technology environment**

As a hardware-agnostic solution, Mangrove offers secure flexible data ingestion options to ingest data from sources across your value chain, including meter data, third-party data, data warehouses, and third-party monitoring data.

**Operate your CO<sub>2</sub> hub with confidence**

Request and share data from upstream, midstream, and downstream partners across the carbon chain of custody to provide end-to-end carbon accounting across multiple CO<sub>2</sub> sources and storage points to correctly attribute CO<sub>2</sub> volumes and characteristics back to CO<sub>2</sub> sources. Provide production carbon accounting data back to CO<sub>2</sub> sources for them to execute their commercial strategy (45Q, 45Z, 45V, EU ETS, CBAM, VCM).



QUORUM SOFTWARE

# CARBON STORAGE RESOURCE MANAGEMENT



ccus@quorumsoftware.com

www.quorumsoftware.com

## SUMMARY

In a low-carbon environment, underground CO<sub>2</sub> storage has the potential to be a cash-flow generating asset. This includes both mature, operational CCS projects as well as immature, future CCS projects. Like all corporate assets, CO<sub>2</sub> storage owners should track and estimate the value of all CO<sub>2</sub> storage assets. Quorum's Carbon Storage Resources Management solution enables CCS operators to analyse the capacity of their CO<sub>2</sub> storage assets and understand how that capacity is changing over time.

## BENEFITS

- Track and analyse the full portfolio of CO<sub>2</sub> storage assets – Quorum's Carbon Storage Resources Management application serves as a single source of truth for a full portfolio of CO<sub>2</sub> storage assets.
- Supports SPE's CO<sub>2</sub> Storage Resources Management System (SRMS) - align with the industry standard framework for managing and reporting CO<sub>2</sub> storage resources.
- Spend less time gathering data – engineers will have more time to analyse storage resources data and support decision-making.
- Reduce risk of data entry errors – company-specific data quality checks to identify errors early in the data gathering workflow.
- Scalable for companies of all sizes - from small independents to international supermajors, companies around the world can take advantage of our solution.
- Future proof your CO<sub>2</sub> storage business – capture and report CO<sub>2</sub> storage resource estimates in a structured manner in preparation for future regulatory requirements.

## KEY DATA

TRL	9	Deployment:	Software-as-a-Service
Technology	SRMS, UNFC or company-specific reporting frameworks	CCS Project Maturity	All - Operational and Under Development.
APIs Available:	Odata		
Target Industries	Storage Resource Owners		

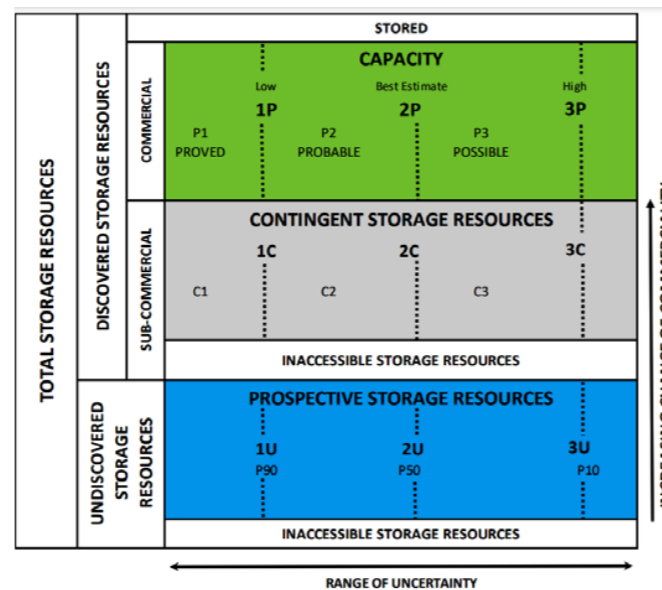

## TECHNOLOGY DESCRIPTION

Quorum's Carbon Storage Resources Management is a cloud-based solution that captures storage estimates across a resource owner's full portfolio of assets from mature, operational projects to less mature contingent or prospective storage resources. It is a best practice for a resource owner to gather estimates for all storage assets – to understand their value in the context of all corporate assets and prioritize investment accordingly.

The capacity of CO<sub>2</sub> storage assets changes year-over-year for a variety of reasons such as reservoir performance or economic conditions. Quorum's Carbon Storage Resources Management solution reconciles year-over-year changes allowing a CO<sub>2</sub> storage owner to understand which factors are driving fluctuations in estimated reservoir capacity. The diagram below illustrates the change in CO<sub>2</sub> storage estimates over the course of a year. The starting estimate is represented by the bar on the left side. The ending estimate is represented by the bar on the right side. The items in between reconcile the difference in starting and ending estimates due to technical or economic factors.

Quorum's Carbon Storage Resources Management application is an extension of one of Quorum's world-class software applications. Our application, Quorum Reserves, is used by oil and gas producers to track, estimate, and analyse oil and gas volumes in underground reservoirs. The same technology in Quorum Reserves has been used for Quorum's Carbon Storage Resources Management software application.

## STORAGE RESOURCES MANAGEMENT SYSTEM (SRMS)

The Society of Petroleum Engineers (SPE) has developed a common framework for resource owners to account for CO<sub>2</sub> storage resources called the Storage Resources Management System (SRMS). Quorum's Carbon Storage

Resources Management application aligns with the SRMS framework.

The diagram illustrates the structure of the SRMS framework. It has two axes. The vertical axis indicates the maturity of a CCS project which is measured by the chance of commerciality. The most mature projects are accounted for as "capacity", followed by 'contingent storage resources' and finally the least mature "prospective storage resources." The horizontal axis indicates the range of uncertainty of CO<sub>2</sub> storage capacity in a resource. As a project matures toward commerciality there is typically a narrower range of uncertainty. Resource owners usually capture three deterministic estimates of a CO<sub>2</sub> storage resource: a low estimate, a best estimate, and a high estimate.

## QUORUM SOFTWARE

Quorum Software is a leading provider of energy software worldwide, serving more than 1,800 customers across the entire energy value chain in over 55 countries. Quorum's solutions power growth and profitability for energy businesses by connecting people, workflows, and systems with decision-ready data. Twenty years ago, we delivered the industry's first software for gas plant accountants, and today our solutions streamline business operations with industry-forward data standards and integrations. The global energy industry trusts Quorum's experts and applications to successfully navigate the energy transition while delivering value today and into the future. Please see our website:

<https://www.quorumsoftware.com/solutions/energy-transition/carbon-capture-utilisation-and-sequestration/carbon-storage-resources-management>

**Country, Field**

- Argentina
- Canada
- France
- Germany
- Norway
- UK
- USA

**Resource Category**

- 01 P1 On Injection
- 02 P2 On Injection
- 03 P3 On Injection
- 04 P1 Approved
- 05 P2 Approved
- 06 P3 Approved
- 07 P1 Justified
- 08 P2 Justified
- 09 P3 Justified
- 10 C1 Pending

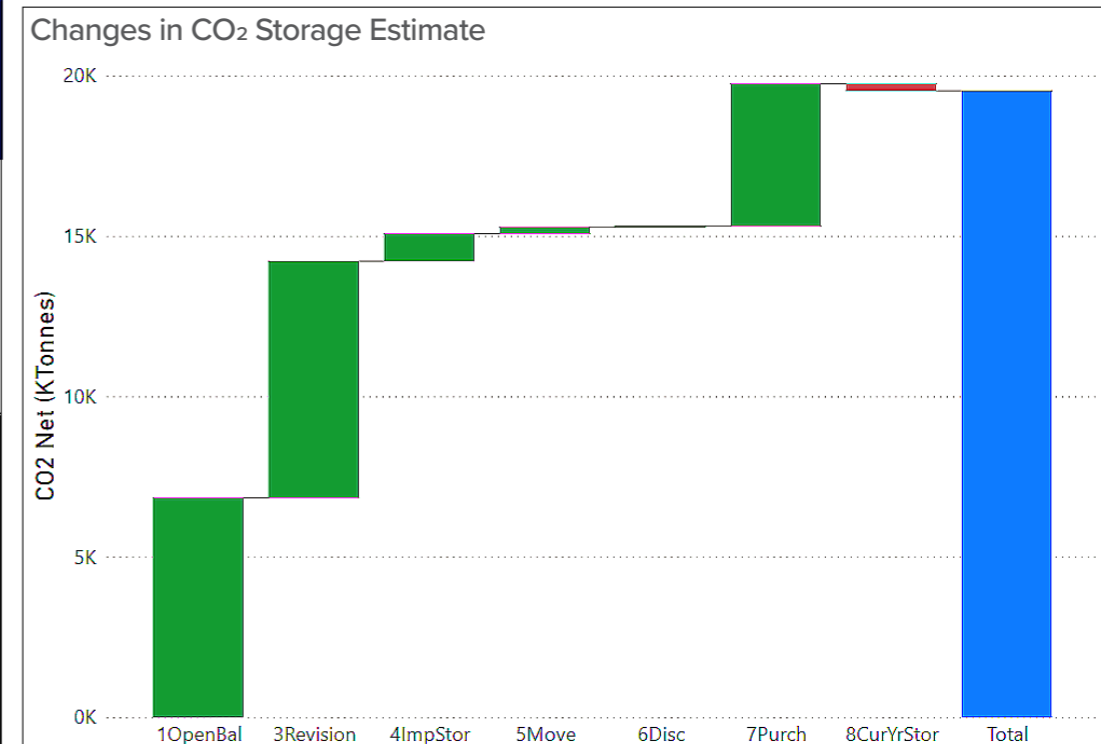



[ccus@quorumsoftware.com](mailto:ccus@quorumsoftware.com)

[www.quorumsoftware.com](http://www.quorumsoftware.com)

**SUMMARY**

The Carbon Capture and Storage (CCS) process involves collecting (capture) CO<sub>2</sub> from industrial processes or from the atmosphere, transporting the CO<sub>2</sub> via pipelines and injecting it into underground geologic formations. During this highly technical process, CO<sub>2</sub> is handled in both gas and liquids (supercritical) phases making accurate measurement data management both a challenge and a requirement for successful and ongoing profitability of CCS projects.

The responsibility of custody transfer measurement points means CO<sub>2</sub> must be measured and correctly accounted for at the capture point, pipeline inlets, pipeline outlets, pipeline linepack/inventory, storage injection points, and finally, the storage inventory must also be tracked and balanced. A CCS operator must have a strong toolset to consolidate, review, correct and distribute an immense amount of measurement data across the organisation. In addition, the CCS operator must perform this with the knowledge that the measured CO<sub>2</sub> and inventory are accurate to minimise legal and financial exposure and maximise revenue. FLOWCAL by Quorum is the tool that enables CCS operators manage CO<sub>2</sub> measurement data.

**BENEFITS**

- Support for CO<sub>2</sub> measurement in both gas and liquids (dense) phase.
- Support for a wide range of metering technologies such as coriolis, ultrasonic, orifice, linepack/linefill, caverns, etc.
- Compliance with measurement industry standards and regulations.
- Physical balancing by volume and mass.
- Meet internal and external audit requirements.
- Financial risk reduction/elimination.

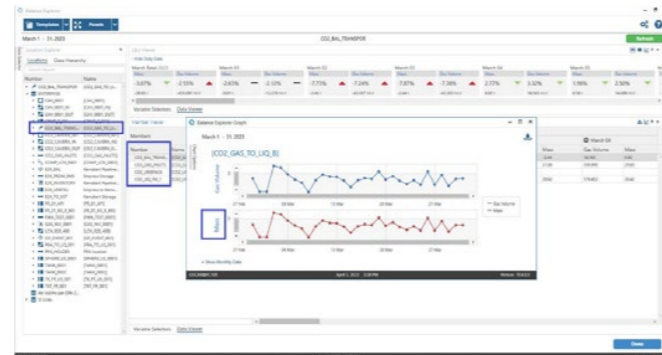

**KEY DATA**

TRL	9	FLOWCAL Installations	200+
Technology	Gas and Liquid Measurement Solution	CCS Project Maturity	Operational or Pilot
Deployment	Self-hosted or cloud-hosted	Years of Proven Accuracy	25+
Target Industries	Operators of CO <sub>2</sub> Transportation Infrastructure or Storage Resources		

**TECHNOLOGY DESCRIPTION**

FLOWCAL by Quorum Software is one of the most robust measurement data management systems available, streamlining the measurement process and optimising data integrity. Designed to operate as a data warehouse capable of serving the needs of an entire organisation, FLOWCAL provides a corporate solution for the most demanding system requirements. It can be applied to CO<sub>2</sub> measurement, hydrocarbon measurement (gas and liquids), helium and hydrogen measurement.

FLOWCAL is used by the largest energy producers and midstream operators to ensure every drop of hydrocarbon is reviewed and accounted for. New CCS operators are starting to rely on FLOWCAL to ensure their stringent measurement needs are met in support of their financial goals. FLOWCAL has an extensive toolset to avoid costly errors by using validation routines that flag erroneous data and identify issues in the field, reduce measurement uncertainty, identify 'Lost And Unaccounted For', physical system balance, and minimise risk by ensuring compliance, data transparency and a complete secure audit trail.

In summary, FLOWCAL enables CCS operators to review, correct, and account each CO<sub>2</sub> molecule whether it is in gas or dense phase, in the pipeline or in underground storage. FLOWCAL can manage CO<sub>2</sub> custody transfer data, balance the captured versus the injected CO<sub>2</sub>, keep

track of CO<sub>2</sub> inventories in the pipe and underground, and provide a holistic view of the CO<sub>2</sub> moved across the CCS operation. System balancing can be managed from gas volume balance, liquids volume balance, and mass balance perspective providing a bird's eye view of the entire CCS system.

**QUORUM SOFTWARE**

Quorum Software is a leading provider of energy software worldwide, serving more than 1,800 customers across the entire energy value chain in over 55 countries. Quorum's solutions power growth and profitability for energy businesses by connecting people, workflows, and systems with decision-ready data. Twenty years ago, we delivered the industry's first software for gas plant accountants, and today our solutions streamline business operations with industry-forward data standards and integrations. The global energy industry trusts Quorum's experts and applications to successfully navigate the energy transition while delivering value today and into the future. Please see our website:

<https://www.quorumsoftware.com/solutions/measurement/gas-liquid-measurement/>

**Liquid Volume Statement - By Product**  
March 2023



Meter #: CO2\_LIQ\_INJ\_1  
 Meter Name: [CO2\_LIQ\_INJ\_1]  
 Product: CO2 - CSS  
 Table: NIST 23 V9.0

Contract Hour:	Midnight	Pressure Base:	14.096	DMF:	1.0000	Meter Type:	Coriolis							
Contract Day:	1	Temperature Base:	60.0	K-Factor:	1.0000	Calc. Method:	API (Direct Mass)							
Mass %:	CO2 99.739	N2 0.168	C1 0.095	C2	C2H4	C3	C3H8	IC4	NC4	C4H8	IC5	NC5	neo	C6+
Liq Vol %:	99.531	0.168	0.259											

Day	Meter Temp (°F)	Meter Pressure (psi)	Flowing Density (REL)	Pulses	Meter Factor	Mass (tonnes)	Base Density (REL)	Net Std.Vol (NSV) (bbl)	Summed Volume (bbl)	Net Allowable (bbl)
1	53.7	1244	0.8997	65,044	1.0025	29,850	0.8099	232.04	230.37	230.37
2	56.8	1248	0.8971	64,566	1.0025	29,360	0.8099	228.23	226.58	226.58
3	59.7	1248	0.8968	62,939	1.0025	28,620	0.8099	222.48	220.87	220.87
4	56.8	1250	0.8785	66,897	1.0025	30,420	0.8099	236.47	234.77	234.77
5	57.4	1248	0.8758	66,919	1.0025	30,430	0.8099	236.55	234.84	234.84
6	55.2	1249	0.8843	65,844	1.0025	29,850	0.8099	232.04	230.37	230.37
7	53.4	1244	0.8908	64,192	1.0025	29,190	0.8099	225.27	223.57	223.57
8	57.9	1249	0.8739	63,511	1.0025	28,880	0.8099	224.50	222.88	222.88
9	58.7	1242	0.8703	63,467	1.0025	28,890	0.8099	224.35	222.73	222.73
10	56.7	1245	0.8665	63,379	1.0025	28,820	0.8099	224.03	222.42	222.42
11	59.1	1244	0.8988	64,874	1.0025	29,500	0.8099	229.32	227.67	227.67
12	55.0	1244	0.8949	66,897	1.0025	30,420	0.8099	236.47	234.77	234.77
13	59.5	1246	0.8974	66,435	1.0025	30,210	0.8099	234.84	233.14	233.14
14	52.3	1250	0.8953	64,258	1.0025	29,220	0.8099	227.14	225.50	225.50
15	51.4	1245	0.8982	63,423	1.0025	28,840	0.8099	224.19	222.57	222.57
16	51.4	1243	0.8980	63,335	1.0025	28,800	0.8099	222.88	222.26	222.26
17	51.0	1250	0.8998	63,885	1.0025	29,050	0.8099	225.82	224.19	224.19
18	59.7	1250	0.8669	66,897	1.0025	30,420	0.8099	236.47	234.77	234.77
19	52.1	1245	0.8956	65,270	1.0025	29,880	0.8099	230.72	229.05	229.05
20	54.7	1246	0.8881	65,754	1.0025	29,900	0.8099	232.43	230.75	230.75
21	51.9	1241	0.8980	64,324	1.0025	29,250	0.8099	227.38	225.74	225.74
22	52.8	1244	0.8929	64,192	1.0025	29,190	0.8099	226.91	225.27	225.27
23	55.7	1245	0.8823	64,104	1.0025	29,150	0.8099	226.60	224.96	224.96
24	54.8	1246	0.8856	63,181	1.0025	28,730	0.8099	223.34	221.72	221.72
25	54.5	1247	0.8871	65,894	1.0025	29,950	0.8099	232.82	231.14	231.14
26	56.2	1241	0.8800	64,676	1.0025	29,410	0.8099	228.62	226.97	226.97
27	56.0	1241	0.8808	65,754	1.0025	29,900	0.8099	232.43	230.75	230.75
28	59.1	1248	0.8993	66,507	1.0025	30,270	0.8099	235.31	233.61	233.61
29	55.0	1244	0.8846	65,578	1.0025	29,820	0.8099	231.81	230.13	230.13
30	57.0	1243	0.8772	64,742	1.0025	29,440	0.8099	228.85	227.20	227.20
31	55.3	1246	0.8838	65,160	1.0025	29,630	0.8099	230.33	228.67	228.67
<b>Total</b>	<b>55.7</b>	<b>1246</b>	<b>0.8820</b>	<b>2,012,331</b>	<b>1.0025</b>	<b>915,060</b>	<b>0.8099</b>	<b>7,113.30</b>	<b>7,061.94</b>	<b>7,061.94</b>





[ccus@quorumsoftware.com](mailto:ccus@quorumsoftware.com)

[www.quorumsoftware.com](http://www.quorumsoftware.com)

**SUMMARY**

Planning and developing Carbon Capture, Utilisation and Storage projects necessitates the integration of the input of many technical and commercial functions. The quality of this integration, together with the ability to assess effectively and transparently all alternative development options, is essential to maximising the value of these projects. Furthermore, these projects are fraught with uncertainties, from the storage capacity, the costs and performance of all the wells and facilities involved as well as scheduling of the execution and operational activities. Throughout the maturation of these projects, storage owners are faced with decisions such as how many CO<sub>2</sub> injection wells are needed, what should the capacity of transmission pipelines and/or processing facilities be, and how to manage risks associated with the development? Each of these decisions will impact the success of the project both in terms of financial success and amount of CO<sub>2</sub> that can be captured and safely stored. Quorum's PetroVR application empowers engineers and planners to assess and compare all the development alternatives available, factoring in the impact of the risks and uncertainties into the decision-making process throughout the maturation process of these large and complex CCUS projects.

**BENEFITS**

- Enhance and streamline CCUS project evaluation through integrated simulation covering all technical and commercial aspects into a single, comprehensive application.
- Manage production goals and net-zero commitments – actualise the challenges of net-zero development with easily configurable tooling to enable development planning and production optimisation.
- Understand the impact of the project risks and uncertainties and factor this into the decision-making process.
- Improve the quality of the CCUS project development decisions throughout the project maturation process with the ability to assess and compare transparently and consistently the various development alternatives available, understand the trade-offs between these, and select the one that fits best your corporate strategic objectives.
- Simulate the development of your CCUS project under uncertainties through Monte Carlo analysis.

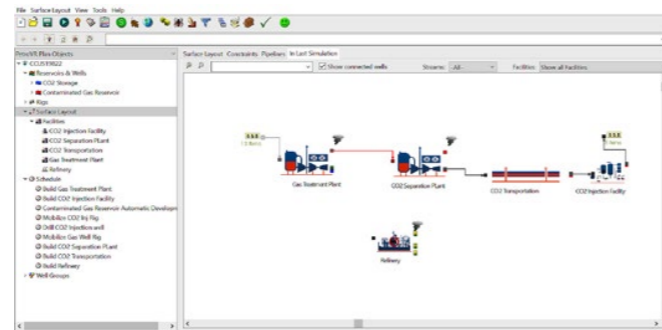

**KEY DATA**

TRL	9	CCS Project Maturity	Under Development
Technology	Discrete and Continuous Dynamic Event Simulator	Deployment	Self-hosted
Target Industries	Storage Resource Owners or Potential Users		

**TECHNOLOGY DESCRIPTION**

Quorum's PetroVR application is a comprehensive fullcycle, integrated simulation software for exploration and development projects including specific functionalities to cover the CCUS use-case.

PetroVR is built on more than 20 years of oil & gas field development experience. It permits engineers and planners to configure the model of their asset as necessary to reflect specific areas of complexity. It has an integrated simulation capability where users can specify any object and associated activities necessary to model their project throughout its life cycle. This includes reservoirs, wells, and facilities but also specific CO<sub>2</sub> storage: CO<sub>2</sub> injection wells and CO<sub>2</sub> injection facilities. An illustration is provided in the figure below.

The application simulates the project execution and operation in a time step fashion covering the entire life of the project, consistently applying inputs, constraints and rules as specified by the user and thereby computing the expected production and injection volumes as well as the associated costs incurred through time, allowing the assessment of the economic viability of the project.

In addition to simulation capabilities, PetroVR has an advanced scenario manager enabling the easy and transparent generation of alternative development scenario models. This functionality facilitates the comparison of the development alternatives identified by the user making the "what if" analysis easy, transparent, and greatly enhancing the ability to generate insights into the trade-offs between decisions.

Many project engineers and planners rely on aggregating inputs from various spreadsheets to model their field development plan and possible alternatives. While spreadsheets are flexible, they are prone to errors. The approach is often cumbersome, time-consuming and does not offer any standardisation across asset teams. PetroVR permits companies to replace spreadsheet modelling with a powerful business simulation approach that integrates all the elements of their project.

The PetroVR application facilitates probabilistic analysis through its easy-to-use Monte Carlo functionality. Users can specify the range of uncertainty for every input variable that they need to consider in the evaluation of the project and generate the full range of expected outcome for any selected value measure reflecting all the uncertainties specified (see example below). CCUS are large and complex projects with many technical uncertainties as well as commercial. Factoring these uncertainties in the decision-making process is essential.

Quorum's PetroVR application has a long-standing track record of adding value and reducing risks associated with field development. CCUS operators can take advantage of this application's powerful simulation, scenario analysis and probabilistic evaluation capabilities to guide and support their project development decision-making.

**QUORUM SOFTWARE**

Quorum Software is a leading provider of energy software worldwide, serving more than 1,800 customers across the entire energy value chain in over 55 countries. Quorum's solutions power growth and profitability for energy businesses by connecting people, workflows, and systems with decision-ready data. Twenty years ago, we delivered the industry's first software for gas plant accountants, and today our solutions streamline business operations with industry-forward data standards and integrations. The global energy industry trusts Quorum's experts and applications to successfully navigate the energy transition while delivering value today and into the future. Please see our website:

<https://www.quorumsoftware.com/solutions/planning-economics-reserves/asset-development-planning/petrovr/>

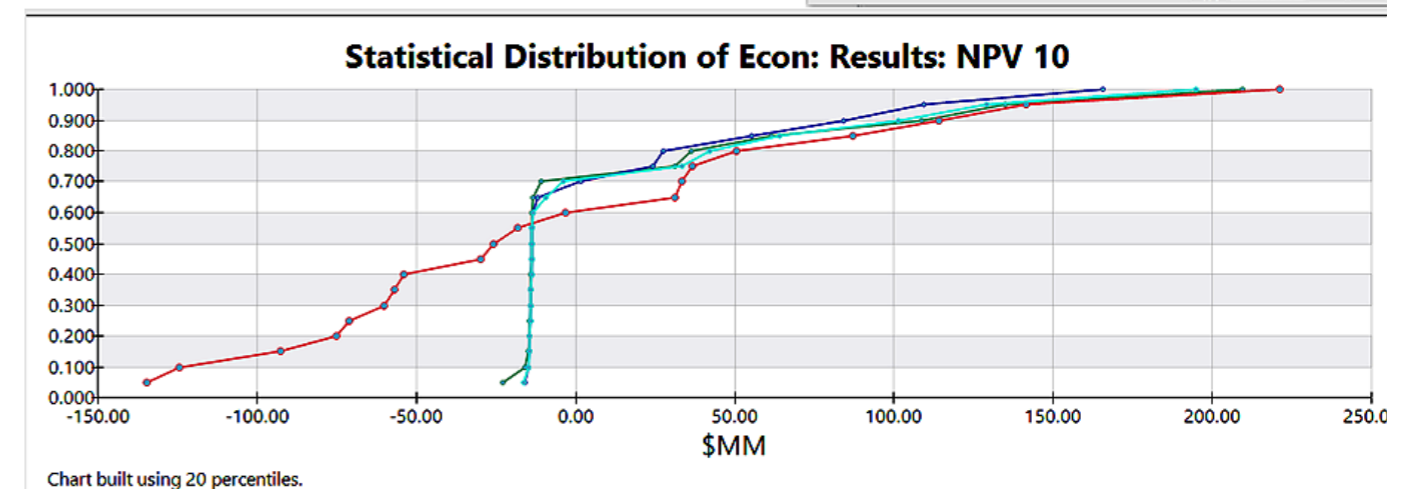
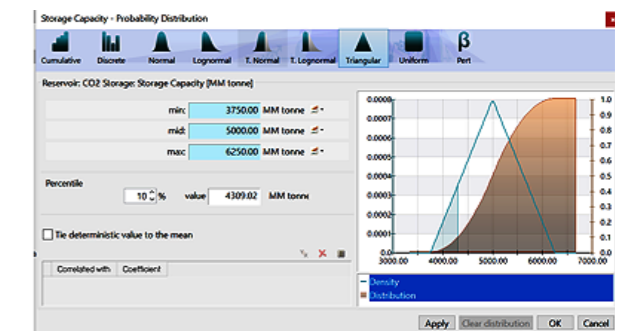
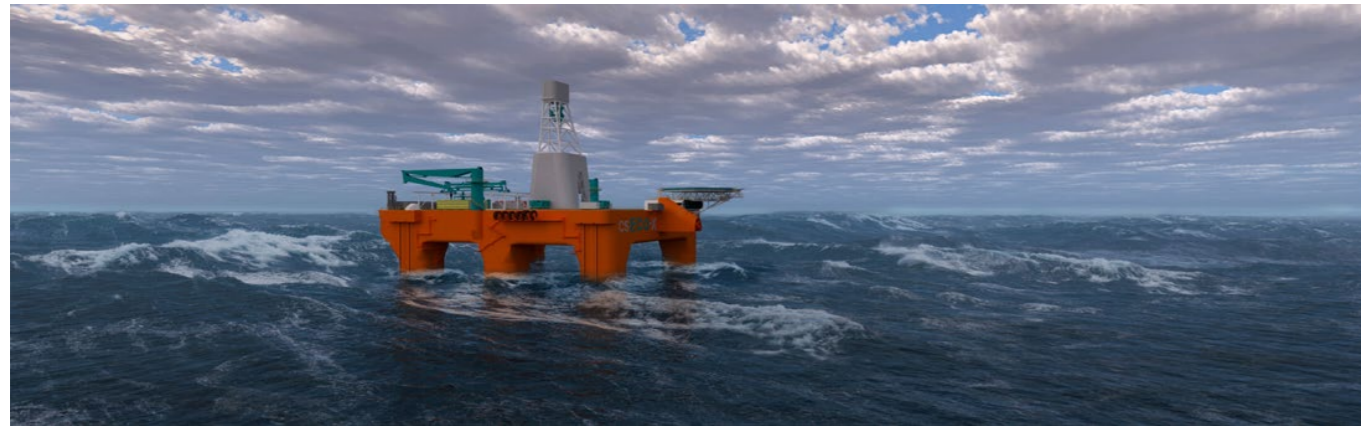

Chart built using 20 percentiles.



[mail@mossw.com](mailto:mail@mossw.com)

[www.mossw.com](http://www.mossw.com)

## SUMMARY

Saipem is a global leader in the engineering, drilling, and construction of large projects for the energy and infrastructure sectors and provides a full range of net zero-oriented services for its clients operating in both the energy transition and the offshore and onshore oil & gas sectors.

Saipem's subsidiary, Moss Maritime, has designed some of the world's largest and most advanced semi-submersible drilling platforms. A total of 29 Moss CS platforms are built or under construction, including rigs of the low environmental footprint Moss CS Eco™ series. All offer excellent operability and an unmatched track record in harsh environments. The latest design, the Moss CS Eco-X™, is the rig technology for the future, ideally suited and optimised for drilling CO<sub>2</sub> injection wells.

## BENEFITS

- The Moss CS semi-submersible catamaran platform is a proven and robust design with 29 platforms already built or under construction.
- Excellent operability confirmed by operators and unmatched track record in harsh environments.
- The last-generation Moss CS Eco™ platform series offers low environmental impact and reduced operating costs thanks to the latest rig technology, fully electric drilling operations, and a hybrid power system.
- Saipem's drilling fleet, currently consisting of 15 vessels, includes drillships, jack-ups and semi-submersibles capable of operating at all depths as well as in harsh environments.
- The Moss CS ECO-X™ is the rig design for the future, enabling safe and environmentally sustainable drilling operations, ideally suited for drilling of CO<sub>2</sub> injection wells:
  - Reduced unit size and cost
  - Maximised and flexible deck space with flush working deck/drill floor
  - Modularised solutions
  - Alternative (clean) fuels
  - Automated and remotely operated equipment
  - Minimum manning

## KEY DATA

TRL	9
-----	---

## TECHNOLOGY DESCRIPTION

### DRILLING FLEET

Drilling is in Saipem's DNA. Did you know that the "P" in SAIPEM stands for Perforazione (Drilling)?

Saipem's drilling operations date back to when the company began more than 60 years ago, with the first operations taking place in 1959 off the coast of Gela in Sicily.

Saipem owns and operates a world-class offshore drilling fleet capable of conducting operations in the most demanding conditions, drilling the deepest and most technically challenging wells. The fleet includes several high-tech and advanced drilling units, including the Moss CS semi-submersible catamaran platforms.

Saipem's offshore drilling fleet has the latest drilling technology, ensuring clients receive safe, efficient, and reliable drilling services. The fleet is operated by highly qualified, committed, motivated personnel with a strong safety culture, capable of facing any situation and responding promptly in the most complex scenarios.

This is not just a question of offshore drilling. It is true passion coming from an extraordinary past, a proud present and an exceptionally promising future.



Saipem Scarabeo 8 – a Moss CS semi-submersible drilling rig

### MOSS MARITIME ECO DRILLING FLOATERS

The Moss CS-series of semi-submersible catamaran platforms has established itself over the last 25 years as one of the most successful and widely used platform designs. Ranging in size from only 25,000 tons displacement up to 75,000 tons, the CS-series platforms are rugged and long-lived with excellent motion characteristics. Their success comes from the flexibility and versatility of the design and the ability to meet a large variety of requirements. The structural layout of the lower hull allows alternative deck arrangements and installation configurations.

Field-proven in the harshest environments, the Moss CS guarantees a long life with outstanding performance.

### RIG FOR THE FUTURE – MOSS ECO-X™

Building on the proven and safe Moss CS design, the ECO-X™ is a quantum leap towards more sustainable drilling operations, taking the Eco™ design even further into the future. Alongside the decarbonisation effort in a time of energy transition, the concept will save cost through reduced OPEX coupled with unmatched uptime and operating efficiency. The aim has been to offer a design with limited to no emissions, enabling clients to meet their targets and ambitions of decarbonised operations. This is achieved through a hybrid power system, exhaust cleaning, the introduction of clean fuels and a plug-in option.

The CS ECO-X™ concept is ideally suited for drilling CO<sub>2</sub> injection wells. It implements the latest state-of-the-art technologies for digitalisation and automation to increase the operational safety while optimising crew efficiency over time. Further, maintenance is condition-based rather than calendar-based, using a digital platform for collecting and analyzing performance data of critical equipment, resulting in optimum asset operation.

The Moss CS has already been successfully utilised for well-drilling operations around the globe, demonstrating its effectiveness and reliability. Its advanced design and capabilities make it an ideal platform for developing carbon storage projects worldwide.



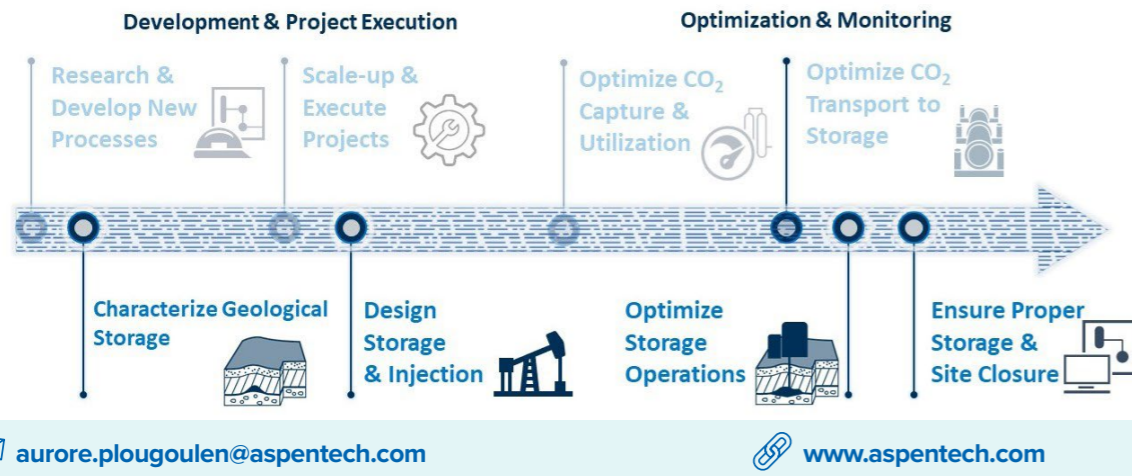

[aurore.plougoulen@aspentech.com](mailto:aurore.plougoulen@aspentech.com)

[www.aspentech.com](http://www.aspentech.com)

### SUMMARY

AspenTech is an industrial software company with over 40 years of history in innovation, and a digital portfolio that provides a comprehensive, holistic approach to asset optimisation and process decarbonisation across design, operations and maintenance. Throughout the CCUS value chain and across the asset lifecycle, AspenTech combines the power of AI with our domain expertise to support the development of scalable carbon capture and carbon storage solutions, prioritise investment decisions, improve efficiencies and have visibility across all stages of the value chain.

Digital technologies applied to carbon capture and removal, transportation, and storage, enable ongoing innovation, rapid scaling, and increased confidence in geological CO<sub>2</sub> storage. The powerful combination of AspenTech solutions and an Industrial AI approach for process simulation and optimisation, subsurface geophysical and geological modelling and digital grid management, deliver performance breakthroughs at scale—both economically and at an accelerated pace, to meet the requirements of industrial carbon mitigation.

### BENEFITS

- Streamline the carbon storage site selection process
- Ensure project viability with a thorough evaluation of storage capacity, containment, and site ability for injection and permanent storage
- Reduce geological risk in carbon storage to make informed investment decisions
- Optimise injection conditions to maximise the net present value of CCS projects
- Demonstrate regulatory conformance through efficient CO<sub>2</sub> movements monitoring data analysis, interpretation and integration

### KEY AREAS

- **Geologic Characterisation:** AspenTech Subsurface Science & Engineering provides comprehensive solutions from seismic interpretation to reservoir modeling, enhancing confidence in carbon storage sites and supporting permit applications. Our suite enables uncertainty propagation for assessing their impact on storage capacity and containment.
- **Carbon Injection And Storage Optimisation:** Optimise CO<sub>2</sub> injection and storage under uncertainties through flow simulation, considering surface and subsurface constraints to make reliable informed decisions and maximise the asset net present value.
- **Long-Term Monitoring Of Geological Storage:** AspenTech Subsurface Science & Engineering provides tools to analyse and interpret monitoring measurements and to efficiently update 3D models and performance prediction through automated workflow for model calibration

### KEY DATA

TRL	9
-----	---

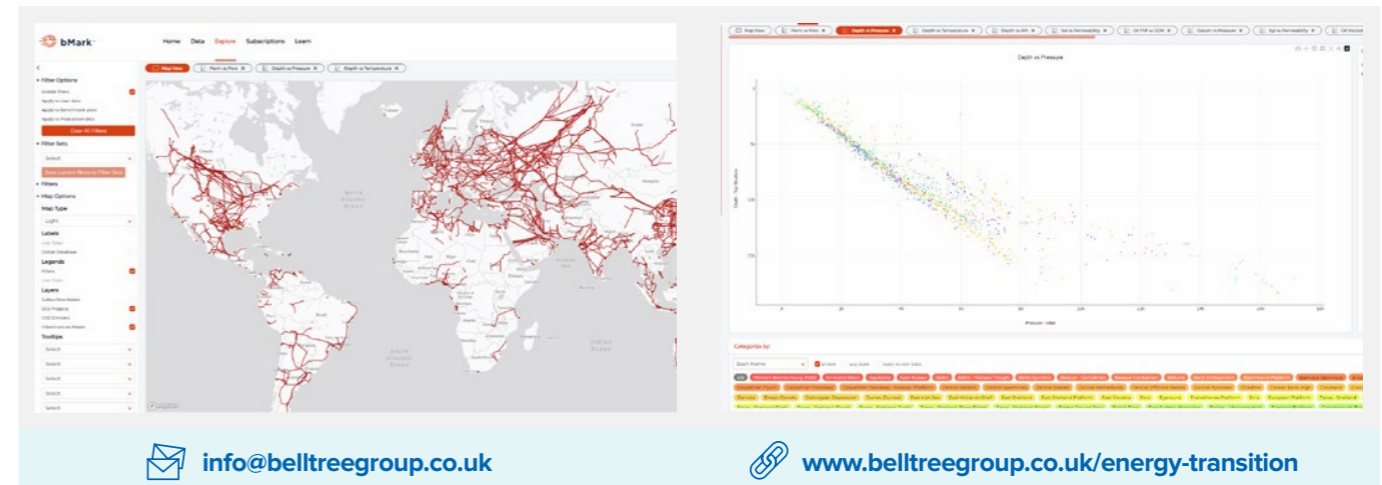

[info@belltreegroup.co.uk](mailto:info@belltreegroup.co.uk)

[www.belltreegroup.co.uk/energy-transition](http://www.belltreegroup.co.uk/energy-transition)

### SUMMARY

bMark™>CCS software offers a robust data-driven approach to the screening and benchmarking of Carbon Capture & Storage (CCS) project concepts.

bMark™ allows users to build a comprehensive CCS project portfolio with access to global data on potential CO<sub>2</sub> sources, transport and storage sites linked to a dedicated feasibility screening workflow. In addition, key data on existing and proposed projects from around the world is collated, allowing users to benchmark their project concepts against the current industry standard.

bMark™>CCS integrates seamlessly with the bMark™ Cloud energy analytics platform enabling teams to collaborate by sharing data and analysis in real-time.

### BENEFITS

- **Build CCS Project Portfolios.** Users build custom CCS project concepts leveraging access to a global subsurface dataset of over 51,000 hydrocarbon fields and saline aquifers, a growing suite of potential storage aquifers, 15,000 major CO<sub>2</sub> emissions sites, a global pipeline transport network and their own integrated datasets.
- **Rapidly Assess CCS Feasibility.** Users can design projects, calculate storage capacity and injectivity and align against CO<sub>2</sub> emitter output all within an easy-to-understand dashboard interface.
- **Analyse CCS Risk.** Users rapidly understand the key risk elements within their project concepts using a unique “Storage Quality Index (SQI)” approach. Users can create a detailed risk profile of each project across a multi-parameter domain and rank concepts against each other and existing global projects.
- **Book & Audit Storage Resources.** bMark™>CCS provides guidance for users in preparing their project concepts for classification using the SRMS resource classification system within a dedicated portfolio dashboard.

### EXPAND YOUR CCS PORTFOLIO

- **Integrated Data Analytics.** bMark™>CCS enables you to integrate your data securely and privately into any analysis via easy-to-use data import and management facilities. As it is fully integrated into the existing bMark™ Cloud platform, bMark™>CCS datasets and assessments also integrate with analytics users may prepare in the wider upstream energy space.
- **Global Impact.** bMark™>CCS, is revolutionising the way professionals evaluate and manage CCS projects across the globe. We take pride in seeing the transformative effects of our product on a global scale, having partners across continents helping us tailor our solution to the industry fast-changing needs.

### KEY DATA

TRL	9
Target Industries	O&G companies, CO <sub>2</sub> Emitters, Energy Regulators



✉ [rob.sturgess@cvictus.com](mailto:rob.sturgess@cvictus.com)

🌐 [www.cvictus.com](http://www.cvictus.com)

**SUMMARY**

Deep, unmineable coal seams are an ideal target for CO<sub>2</sub> storage because of the vast global distribution of coal resources and the high storage permanence. The primary gas storage mechanism in coal is adsorption, where CO<sub>2</sub> is adsorbed more strongly than other coal seam fluids, providing a very secure method for sequestration. Cvictus has leveraged proven coalbed methane technologies and the past CO<sub>2</sub> injection and has successfully demonstrated that large quantities of CO<sub>2</sub> can be injected into deep coal seams, paving the way for a larger, more stable sink for CO<sub>2</sub>, at a lower cost than currently required. Cvictus's method for CCS in deep coal is cheap and secure, and can be further improved by integration in their Enhanced Hydrogen Recovery™ (EHR™) technology.

**BENEFITS**

- Injected CO<sub>2</sub> is physically adsorbed onto the coal matrix for proven, permanent, and stable geological sequestration.
- Each tonne of deep coal can physically adsorb over 100 kg of CO<sub>2</sub>, at a cost of <\$10/t of CO<sub>2</sub> sequestered.
- This technology requires resources that are not considered recoverable by surface / underground coal mining, or functional for coalbed methane. There are 30-50 trillion tonnes of suitable resource for CCS around the world, providing value to a stranded, forgotten resource.
- Previous tests (Fenn Big Valley; Allison Unit) demonstrated that large scale sequestration in deep coal is possible, although not economical for its intended purpose of ECBM.
- Huge amounts of the most suitable resources for deep coal CCS are in China, India, Indonesia, and other emerging economies with massive, growing carbon emissions. Cvictus's technology a cost-effective way to decarbonise coal dependent countries that are driving future climate change.

**KEY PROJECTS**

Cvictus and a team of experts including those from the University of Calgary injected a total of 1,512 tonnes of CO<sub>2</sub> into the 1,500-meter deep Mannville coal seam at Cvictus's site near Red Deer, Alberta. Relatively low injection pressures and energy requirements confirm the commercial viability of Cvictus's patented process for carbon sequestration and EHR™.

A [recent peer reviewed paper](#) in the International Journal of Coal Geology summarises analysis and results from the program and outlines the potential for deep coal as a sink for CO<sub>2</sub> sequestration.

This work confirms key components for Cvictus's technology and increases the scientific understanding of the role unmineable coals could play in global decarbonisation.

Cvictus's first 'small' commercial plant in Alberta, Canada – producing 2,500 tonnes a year of clean hydrogen while sequestering all produced CO<sub>2</sub> onsite – will demonstrate the commerciality of this technology.

**KEY DATA**

TRL	5	Number of Commercial Plants	1	Number of Pilot Plants	~
-----	---	-----------------------------	---	------------------------	---

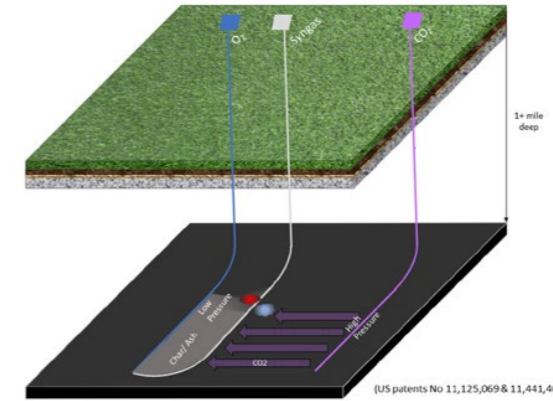

✉ [rob.sturgess@cvictus.com](mailto:rob.sturgess@cvictus.com)

🌐 [www.cvictus.com](http://www.cvictus.com)

**SUMMARY**

Coal has huge, largely unrecognised, potential for carbon sequestration. The key is to co-produce syngas from deep coal symbiotically with carbon capture, use, and sequestration (CCUS) to create the space needed to sequester CO<sub>2</sub> on site and fuel the low-cost energy required for CO<sub>2</sub> capture and compression. Cvictus's patented Enhanced Hydrogen Recovery™ (EHR™) technology mobilises brine and beneficial gases from the coal matrix by injecting CO<sub>2</sub>, while extracting hydrogen-rich syngas. CO<sub>2</sub> is preferentially adsorbed onto the coal matrix. Cvictus has successfully demonstrated that large quantities of CO<sub>2</sub> can be injected into deep coal seams for permanent geological sequestration, opening up a vast new geologic sink for CO<sub>2</sub> at <\$0.10/t of CO<sub>2</sub> sequestered and turning coal 'from a source to a sink' of CO<sub>2</sub>.

**BENEFITS**

- EHR™ is an integrated system, creating all the power needed for capture and compression, and geological space for sequestration onsite – eliminating the need for costly transportation and carbon intensive processing.
- Injected CO<sub>2</sub> is physically adsorbed onto the carbon char in the depleted underground zone and in the adjacent virgin coal for proven, permanent, and stable geological sequestration.
- The injection of CO<sub>2</sub> additionally pushes saline formation water into the gasification panel, increasing hydrogen recovery.
- EHR™ requires deep coal resources that are not considered recoverable by surface / underground coal mining, or functional for coal bed methane. There are 30-50 trillion tonnes of suitable resource around the world, providing value to a stranded, neglected resource.
- Huge amounts of the most suitable resources for EHR™ are in China, India, Indonesia, and other emerging economies with massive, growing emissions. EHR™ is the most realistic, cost-effective way to decarbonise these coal-dependent countries.

**KEY PROJECTS**

- Cvictus is building their first 'small' commercial plant in Alberta, Canada that will produce 2,500 tonnes a year of clean hydrogen while sequestering all produced CO<sub>2</sub> onsite – proving their patented EHR™ and CCS technology for commercialisation.
- The commercial facility will be located at the same site Cvictus and a team of experts injected a total of 1,512 tonnes of CO<sub>2</sub> into a 1,500-meter deep single coal seam in Alberta in 2022.
- EHR™ combines two proven technologies – Underground Coal Gasification (UCG) and CCS to produce the lowest cost, lowest carbon intensity chemical feedstocks.
- UCG has a 60+ year history of successful operations with Cvictus founders leading recent successful demonstrations in New Zealand, Australia, and South Africa.
- A [recent peer reviewed paper](#) in the International Journal of Coal Geology summarises analysis and results from the 2022 CO<sub>2</sub> injection program and the potential for deep coal as a sink for CO<sub>2</sub> sequestration.

**KEY DATA**

TRL	7	Number of Commercial Plants	0	Number of Pilot Plants	1
-----	---	-----------------------------	---	------------------------	---

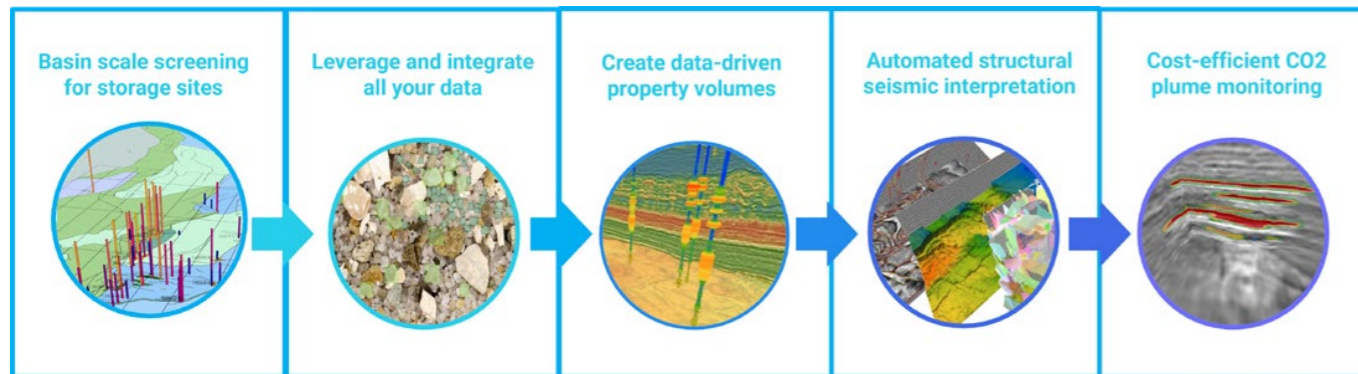

[eirik.larsen@earthanalytics.no](mailto:eirik.larsen@earthanalytics.no)

[www.earthanalytics.ai](http://www.earthanalytics.ai)

**SUMMARY**

CCS is crucial for achieving net zero CO<sub>2</sub> emissions. To become commercially viable, CCS technology and workflows involved need to be cost efficient. EarthNET delivers AI-driven solutions to streamline geoscience workflows and cut associated costs. These workflows, including regional screening, site characterisation, and post-injection monitoring, are traditionally labour-intensive and expensive. In addition, conventional software does not allow for integrated and automated data analysis, leading to underutilisation of available data. EarthNET solves these challenges through AI-assisted geoscience workflows, leveraging the scalability of cloud-native solutions, and data integration made possible through a modern data platform.

**BENEFITS**

- **Go digital:** Compile large, structured data from your multiple data sources and make it available at the geoscientist's fingertips
- **Time and cost reduction:** AI-assisted well- and seismic-scale reservoir and seal evaluation can reduce project cycle times from 9 months to less than 2 weeks using EarthNET
- **Quality:** EarthNET leverages big-data and comprehensive geoscience QC to provide high quality predictions of target properties
- **Integration:** Extract deeper insight by integrating data from microscopy images to logs, and seismic

**KEY PROJECTS**

- Regional reservoir and seal prediction: AI-assisted reservoir and seal characterisation for all exploration wells from Norway
- Gulf of Mexico CCS regional study: AI-assisted workflow and legacy seismic data used to screen for storage sites
- Polaris site characterisation: 3D reservoir and seal characterisation to rapidly and accurately derisk a storage site candidate in Norwegian Barents Sea
- Sleipner CO<sub>2</sub> plume interpretation Automatic seismic interpretation to monitor plume-growth using 4D seismic data

**KEY DATA**

TRL	9	Number of Commercial Plants	2	Number of Pilot Plants	2
-----	---	-----------------------------	---	------------------------	---

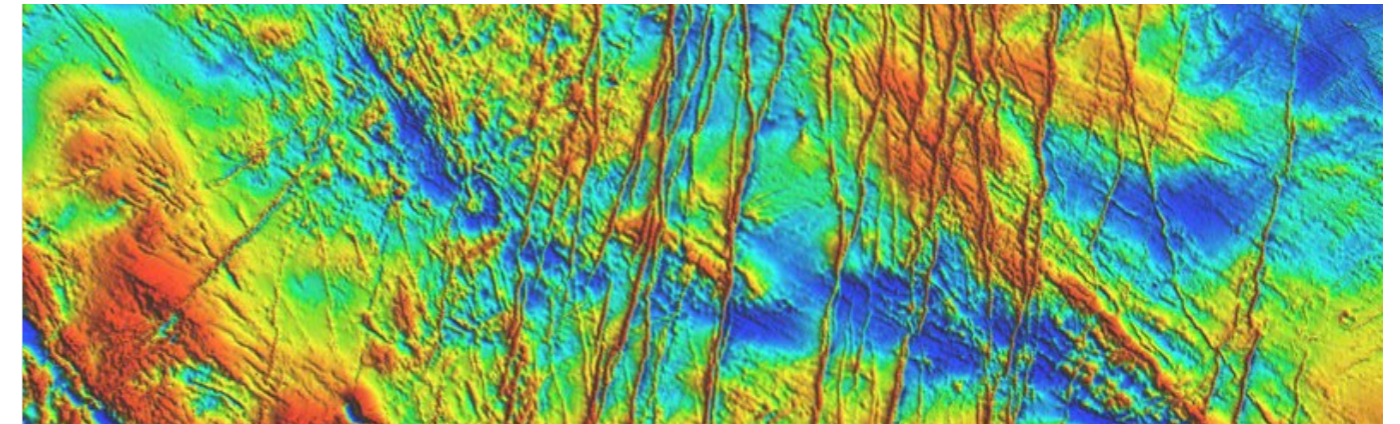

[Simon.Campbell@getech.com](mailto:Simon.Campbell@getech.com)

[www.getech.com/](http://www.getech.com/)

**SUMMARY**

Getech regional (10<sup>2</sup>-10<sup>5</sup> km<sup>2</sup>) fault mapping starts with the world's most comprehensive and quality-controlled gravity and magnetics database, applies advanced processing (including high-pass filtering, total horizontal derivative, and tilt angle), creates robust 2D, 2.5D, and 3D inversions, and picks potential faults using Automated Coherent Lineament Analysis and Selection (ACLAS), a process developed and published by Getech. Additional client geophysical data can be integrated to enhance the analysis, but is not required. Potential faults are iteratively validated and classified into temporal and kinematic families using available topographic, remote-sensing, and geologic (including seismic) data and Getech's plate-tectonic models. Fault azimuths are compared to regional stress measurements to evaluate the chance for fault segments to be under extension or compression. The regional fault framework can be used on its own or serve as the basis for more detailed local interpretation, including planning seismic-monitoring networks or 3D seismic acquisition.

**BENEFITS**

- Can be applied anywhere, even where seismic or well data are sparse.
- Existing Getech database, especially good in US Lower 48 onshore and shallow water, allows immediate project initiation without additional geophysical data acquisition.
- Total project time from kick-off to final delivery can be weeks instead of months or years.
- Existing Getech datasets are regionally consistent, they do not require compilation and QC of diverse legacy data, for example seismic surveys of varying vintage, quality and acquisition/processing parameters.
- Proven approach has been validated over many years in hydrocarbon and geothermal applications worldwide.

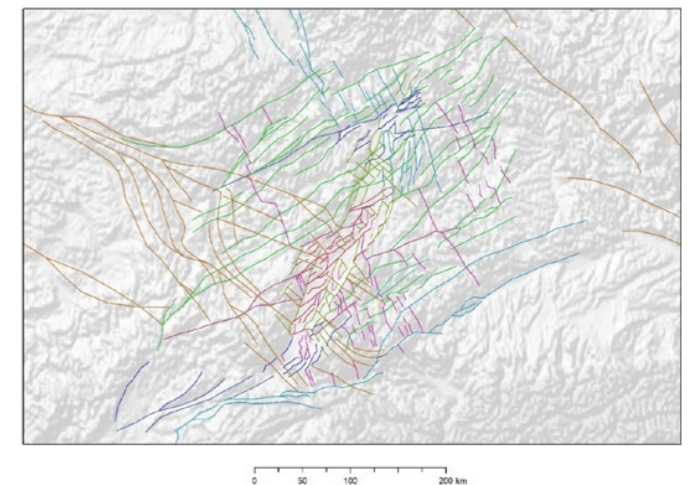

**KEY DATA**

TRL	7	Number of Commercial Plants	1	Number of Pilot Plants	2
-----	---	-----------------------------	---	------------------------	---



Richard.Webb@getech.com

www.getech.com

**SUMMARY**

Exploration Analyst is an extension to Esri's ArcMap and ArcGIS Pro software that assesses potential storage capacity, maps storage segments with common risk profiles, and high-grades storage areas with the best Chance of Success (COS). Exploration Analyst can validate COS maps against well results, calculate prospect volumetrics, perform multi-criteria block or lease analyses, as well as evaluate competitor positions and support portfolio strategy. Exploration Analyst creates individual COS layers for separate geological elements that contribute to successful storage, including reservoir, trap, and seal factors. Layers can be constructed from data or sketched from concepts, and are then combined into a geologic play-chance model. Additional environmental, regulatory, infrastructure, or other elements can be added to the analysis as required. Exploration Analyst provides a wide range of summary maps, graphs, and reports to quickly and intuitively communicate results.

**BENEFITS**

- Agnostic compilation of proprietary, vendor, and public data.
- Efficient integration of inputs from multiple disciplines that facilitates communication among diverse team members.
- Auditable conclusions that can be validated against well results.
- Volumetrics and risk evaluated in a single application.
- Inputs may be rigorously derived from data, loosely sketched from concepts, or anything in between.
- Workflows can be standardised and shared using Tasks, as well as run in batch using Exploration Analyst's geoprocessing tools.

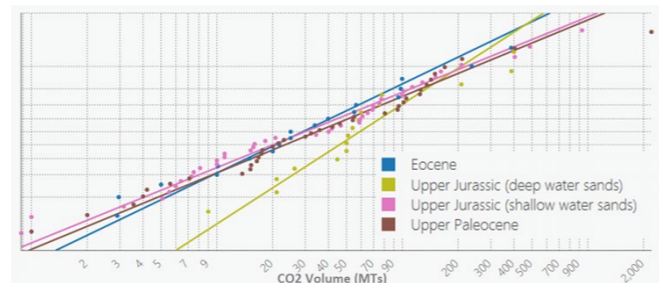
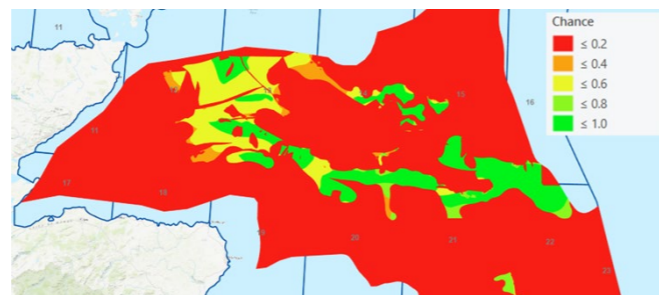

**KEY DATA**

TRL	9	Number of Commercial Plants	25	Number of Pilot Plants	5
-----	---	-----------------------------	----	------------------------	---

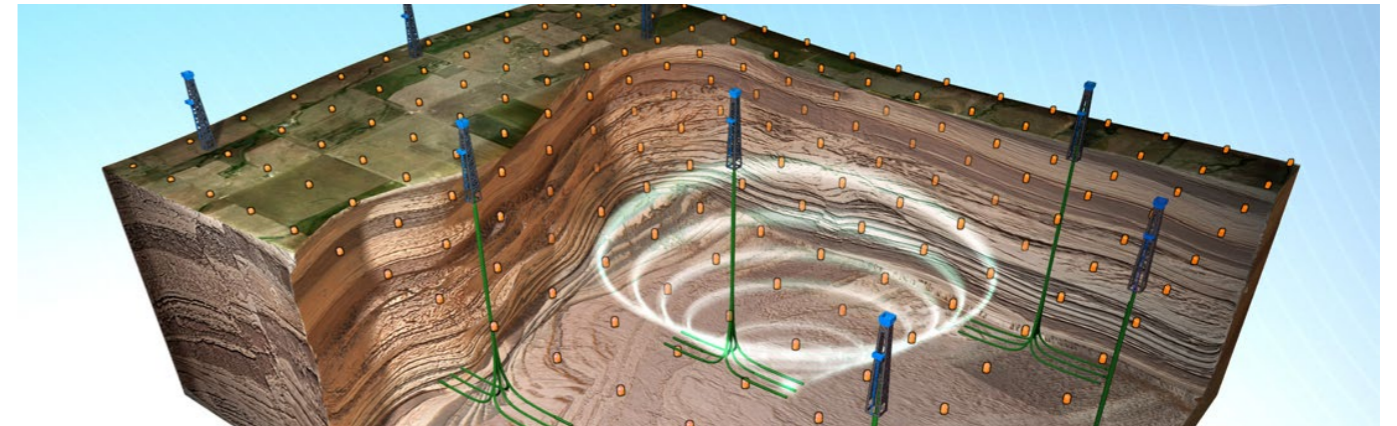

schelette@microseismic.com

www.microseismic.com

**SUMMARY**

CO<sub>2</sub>SeQure® is a division of MicroSeismic, Inc. (MSI) which was founded in 2003 and is based in Houston, TX. MSI is a microseismic industry leader and is noted for pioneering surface and near-surface based geophysical solutions related to Hydraulic Frac Monitoring (HFM) for oil and gas. CO<sub>2</sub> Sequestration projects are growing in number as the practicality of carbon capture, utilisation, and storage (CCUS) to offset GHG emissions becomes a reality. CO<sub>2</sub>SeQure® is a proven solution to monitor, report, and verify (MRV) the sequestered CO<sub>2</sub>.

Our solution assists the CCUS operator in:

1. Confirming the injected CO<sub>2</sub> is confined within the target formation,
2. Monitoring and confirming the caprock integrity such that no CO<sub>2</sub> escapes, and
3. Measuring microseismic events to ensure the injection does not induce seismicity that could potentially damage nearby infrastructure.

**BENEFITS**

MicroSeismic monitoring before/during/after injection is a proven technology for:

- Assessing the seismic hazard in the project area.
- Mapping faults through the reservoir, including those that may not have been imaged by reflection seismic.
- Detecting movement of faults/fractures that could compromise caprock integrity.
- Detecting small precursor seismic events that can predict larger magnitude induced seismicity.
- Tracking the CO<sub>2</sub> plume as it grows during the injection process.

**KEY APPLICATIONS**

- Mitigation of seismic hazards (seismic events felt at the surface) via induced seismicity precursor detection.
- Confirmation of caprock integrity using microseismic event detection.
- Life-of-Field asset protection using real-time actionable intelligence.
- Plume mapping via 3-D/4-D seismic – a low-cost solution compared to conventional 3-D seismic since the receiver array is installed only once, which also means the receiver response is constant for repeated surveys.
- Modular and adaptive approach for MRV plans.
- 24/7 Autonomous solution with low community impact and reduced safety risk.
- CARB (LCFS protocol) compliant and meets EPA's UIC Class VI Program monitoring requirements.

**KEY DATA**

TRL	6 - 7	Number of Applications	~
Target Industries	CCS Storage Facilities and Sites		



[corporatemarketing@nov.com](mailto:corporatemarketing@nov.com)

[www.nov.com/ccs](http://www.nov.com/ccs)

**SUMMARY**

Offshore CO<sub>2</sub> storage excels in scalability, adaptability, and timing over onshore storage options. The two NOV groups; APL and Subsea Production Systems (SPS) provide a combined offshore solution for safe CO<sub>2</sub> transfer and injection into the storage reservoir. Our advanced turret mooring and offloading systems enable CO<sub>2</sub> transfer from CO<sub>2</sub> carriers to floating or fixed structures, which injects the CO<sub>2</sub> into the reservoir, as well as direct injection from the CO<sub>2</sub> carrier. The unbonded flexible pipes designed and certified for corrosive environments and dynamic conditions emerge as the preferred conduit for the injection and subsea distribution of non-cryogenic CO<sub>2</sub> into reservoirs. The CO<sub>2</sub> offloading and injection system is easy to scale and adapt to both batch-wise and continuous operation in all weather conditions.

**BENEFITS**

- High flexibility and fast capacity expansions: The APL/ SPS CO<sub>2</sub> injection system enables CO<sub>2</sub> to be delivered from anywhere directly to the storage site without need for land-based interim storage and long trunklines. It is easy and fast to add capacity when needed.
- Adaptable offloading systems to suit different storage locations: The Single Anchor Loading (SAL) and Submerged Swivel Yoke (SSY) are ideal candidates for shallow water. The Submerged Turret Loading system (STL) is suited for operation in deeper water locations.
- Support different injection principles: The SAL system supports batch-wise injections, while the SSY is ideal for continuous operations. The STL system is suitable for both batch-wise and continuous injections.
- Certified CO<sub>2</sub>-resistant flexible pipes ensure safe CO<sub>2</sub> transport from topside to well. SPS' flexible pipes have a proven track record with high CO<sub>2</sub> content, and new materials are certified for CCS applications.

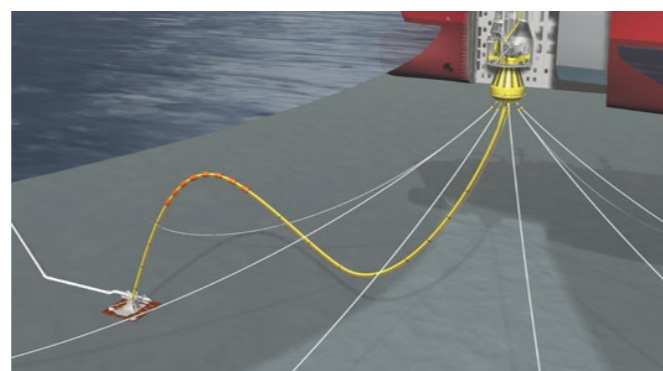

STL - Submerged Turret Loading System

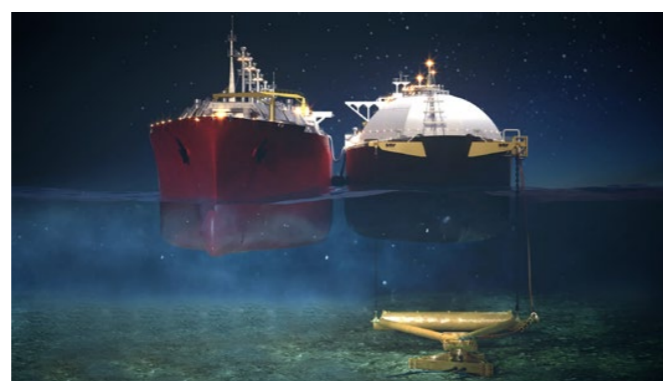

SSY - Submerged Swivel Yoke

**KEY DATA**

TRL	7+	Design Pressure (bar)	0 - 345	Design Temperature (°C)	-20 - 60
Size	4" to 12"	Continuous and batch-wise loading			



[oleg.valishin@sercel.com](mailto:oleg.valishin@sercel.com)

[www.sercel.com](http://www.sercel.com)

**SUMMARY**

Carbon sequestration projects offshore require unique combination of cost effectiveness, data quality, low intrusiveness and long term reliability. While conventional methods used for O&G exploration provide excellent quality results, they cannot compete on cost and intrusiveness. Ultra sparse ocean bottom monitoring enabled by appropriate seismic imaging and microseismic helps solving this challenge. The solution is very cost efficient as it is very sparse (every few hundred meters spacing) ocean bottom nodes (OBNs) designed for both active and passive seismic monitoring, coupled with wireless data transmission to remove the need for trenching and cabling. Free drop node deployment and on demand pop up for harvesting, along with long battery life and field proven sensors and overall design improve productivity.

For efficient result, OBNs need to be complemented by adequate seismic sources with low environmental footprint, automatic marine mammals detection to enable man-less field operations, and reliable data management for delivering quality data from offshore to the processing center.

**BENEFITS**

- Capable of recording both active seismic and microseismic, with automatic on edge detection and transmission while keeping the raw data
- Reduction of CAPEX thanks to wireless underwater transmission, eliminating the need for trenching and cables. On demand transmission capability.
- Reduction of OPEX via free drop deployment and on demand pop-up recovery by a small vessel. Precise acoustic positioning and possibility of redeployment.
- 6000 m depth capability.
- Field proven 3C QuietSeis MEMS and hydrophone for broadband frequencies, eliminating data jitter and sensor aging
- Battery life up more than six months
- Both for sparse active seismic or microseismic baseline and monitoring. Possibility of modification of number of sensors and changing positions
- Offshore or onshore data management platform, time synchronisation and source de-noising
- Integrated with a range active seismic sources depending on the project needs – broadband, reduced marine mammals impact and source management
- Integrated with automatic QuietSea marine mammals detection for man-less operations

**KEY DATA**

TRL	7	Depth capability	Down to 6000 m
Maximum number of nodes	Unlimited	Battery Life	6 months or more
Underwater Range	5 km (more with extension).	Source type	Air, Impulsive, Conventional and Low Frequency
Target Industries	Carbon Sequestration and Oil & Gas Reservoir Characterisation and Monitoring		



SERCEL

## WIRELESS NODAL ACQUISITION SYSTEMS



[Oleg.valishin@sercel.com](mailto:Oleg.valishin@sercel.com)

[www.sercel.com](http://www.sercel.com)

### SUMMARY

How to cost efficiently and effectively characterise and monitor storage sites and optimise operational monitoring of the CO<sub>2</sub> in the subsurface for the land project?

How to provide clients with critical insight, enabling them to optimise their storage and monitoring plans, reduce costs and have greater confidence in site conformance for improved operations and public acceptance?

The CCS industry is facing challenges related to the quality of the data – as monitoring plans rely on very precise initial baselines and reliable subsequent monitoring, thus putting the quality of the data in the headlight with efficient operations cost.

WiNG is one of the most advanced land nodal acquisition system to manage operations easily and efficiently. Equipped with one of the most sensitive, broadband sensors, QuietSeis® it's a key component in acquiring TrueBroadband™ seismic data. The WiNG node offers Pathfinder™ real-time spread QC. The WiNG can record seismic data for up to fifty 24hr days.

### BENEFITS

- Universal solutions, both for exploration and monitoring, and active, passive and microseismic
- No data jitter and manufacturing disparity and ageing for 4D repeatability using QuietSeis MEMS sensor
- Unrivalled low frequency sensing capability in particular critical for microseismic monitoring.
- 1 component or 3 component options. True Fidelity for 3 component version, with no cross talk between vertical & horizontal components
- True amplitude and phase recording, thus reducing induced noise
- Pathfinder Wireless Quality Control enabling more efficient and cost effective operations
- Packaged into the high reliability, low maintenance solution

### KEY PROJECTS

Paragon Geophysical Services, Inc., a leading seismic acquisition contractor based in Wichita, Kansas, US provides subsurface mapping services across the United States in support of energy transition. They enable the highest resolution and quality seismic at cost effective approach using SERCEL WiNG technology. Over 35 CCS projects have been completed by Paragon using WING technology in the continental USA. Nodes system, reliability, wireless Quality Control allowed efficient and cost effective operations in any conditions, from para urban and agricultural land to desert, both including under heavy snow.

### KEY DATA

TRL	8	Autonomy	50 days	Operating Temperature (°C)	-40 to +60
Sample Rate (ms)	4 - 0.5	Number of Commercial Plants	35		
Target Industries	Carbon Sequestration and Oil & Gas Reservoir Characterisation and Monitoring				

SUPERCONDUCTING SENSOR TECHNOLOGY CORPORATION (SUSTEC)



## SQUID-TEM METHOD AS A COMPETITIVE & EFFICIENT CCS/CCM MONITORING TOOL



[contact1@sustec.jp](mailto:contact1@sustec.jp)

[www.sustec.jp](http://www.sustec.jp)

### SUMMARY

We have developed a transient electromagnetic (TEM) exploration system with 3-axis high-temperature superconducting quantum interference device (HTS-SQUID) magnetic sensors. The HTS-SQUID, which is an ultra-highly sensitive magnetometer, allows system to detect deeper TEM signal with a wide bandwidth and to be higher durability against external magnetic field. Our SQUID-TEM system combined with a grounded line excitation source and proprietary 3D inversion analysis can provide 3D resistivity mapping with higher spatial resolution at any given depth (few tens meter to 3000-4000 m). Since TEM method is the most sensitive to a change in formation conductance, resistivity change in a reservoir injected with water/CO<sub>2</sub> or CO<sub>2</sub> plume in the reservoir can be detected as a resistivity contrast. Thus, our SQUID-TEM system is a powerful tool for reservoir monitoring of CO<sub>2</sub> storage operation.

### BENEFITS

- SQUID-TEM method enables detection of CO<sub>2</sub> plume in a reservoir as a resistivity change in a wide range of CO<sub>2</sub> saturation level.
- SQUID-TEM method enables reservoir monitoring of CO<sub>2</sub> storage operation with a competitive cost and lower environmental impact.
- SQUID-TEM method is applicable for both onshore and offshore (shallow water application).

### KEY PROJECTS

- Offshore CCS monitoring project: In Tomakomai offshore large-scale CCS verification site (shallow sea region) in Japan, SQUID-TEM method as an effective monitoring tool have been implemented within a framework of Ministry of Environmental project since 2022.
- Onshore CO<sub>2</sub> storage monitoring project: In a Middle Eastern country, SQUID-TEM method has been deployed since 2023 to verify a development of water/CO<sub>2</sub> plume in the reservoir as a time-lapse survey.

### KEY DATA

TRL	7	Number of SQUID sensors	3(x,y,z)	Total weight	20 kg
Continuous operation time	17 h	Typical data acquisition time	1-2 h /point	Exploration depth	0-4000m
3D inversion analysis	Yes				
Target Industries	CCS (onshore, offshore), CCM, EOR, Geothermal resources, Metal resources				



# GET IN TOUCH

To find out more about the Global CCS Institute including Membership and our Consultancy services, visit [globalccsinstitute.com](https://globalccsinstitute.com) or contact us.

---

## AMERICAS

Washington DC, United States  
[americasoffice@globalccsinstitute.com](mailto:americasoffice@globalccsinstitute.com)

## AUSTRALIA

Melbourne, Australia  
[info@globalccsinstitute.com](mailto:info@globalccsinstitute.com)

## CHINA

Beijing, China  
[chinaoffice@globalccsinstitute.com](mailto:chinaoffice@globalccsinstitute.com)

## EUROPE

Brussels, Belgium  
[europeoffice@globalccsinstitute.com](mailto:europeoffice@globalccsinstitute.com)

## JAPAN

Tokyo, Japan  
[japanoffice@globalccsinstitute.com](mailto:japanoffice@globalccsinstitute.com)

## MIDDLE EAST AND NORTH AFRICA

Abu Dhabi, United Arab Emirates  
[menaregion@globalccsinstitute.com](mailto:menaregion@globalccsinstitute.com)

## UNITED KINGDOM

London, United Kingdom  
[ukoffice@globalccsinstitute.com](mailto:ukoffice@globalccsinstitute.com)

Copyright © 2024 Global CCS Institute

The Global CCS Institute has endeavoured to make the information in this publication as accurate as possible. However, it does not guarantee that the information in this publication is totally reliable, accurate or complete. Therefore, the information in this publication should not be relied upon when making an investment or commercial decisions or provided to any third party without the written permission of the Global CCS Institute.

The Global CCS Institute has no responsibility for the persistence or accuracy of URLs to any external or third-party internet websites referred to in this publication and does not guarantee that any content on such websites is, or will remain, accurate or appropriate.

To the maximum extent permitted, the Global CCS Institute, its employees and advisers accept no liability (including for negligence) for any use or reliance on the information in this publication, including any commercial or investment decisions made on the basis of information provided in this publication.

The Global CCS Institute has relied on the contributions of over 60 CCS technology providers to compile this publication. Any claims regarding technology performance are the responsibility of the company concerned and are not endorsed by the Global CCS Institute. Readers should confirm any details contained in this Compendium with the technology holder concerned.